

Many Happy Returns

No. 36

\$2.50

An International Publication of the United States Boomerang Association

Fall 1988



WHAT'S HAPPENING IN THIS ISSUE?

1988 USBA Nationals	1
Portland Rose Festival	3
Team Gel Diaries	4
Southern Calif. Corroborree	6
New England Corroborree	6
Oakland Gel Boomtest	7
Archaeo-look Boomerang	7
The 1988 Ohio Tournaments	8
Hi-lites: Int'l Team Cup #2	8
1988 Swiss Nationals	9
St. Louis Competitions	9
More Fairy Tales Come True	10
Booms in Literature and TV	11
New Products	12
Kids & Boomerangs	13
News from Overseas	14
New Club in Texas	14
Newsletters from the USA	14
Boomerangs & Computers	15
A Micro-Computer Analysis	16
USBA President's Column	18

photos by Alan Winterrowd

SMASHING USBA NATIONALS

Chet Snouffer wins the USBA Nationals (barely) as he edges out over **John Koehler** in a neck to neck race.

Dennis Joyce is elected as 1988/1989 USBA President.

John Derden sets a new MTA 100 World Record with a time of 50.67 seconds. The auction and annual meeting is a success and a terrific time is had by all. Read all about it in the feature story on page 2 by **John Koehler**.

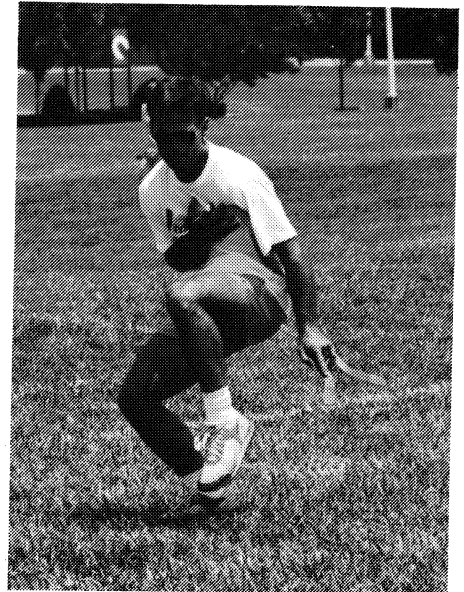

CHET SNOUFFER

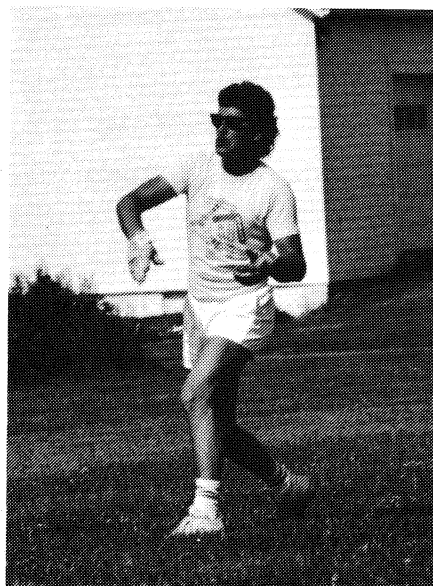

DENNIS JOYCE

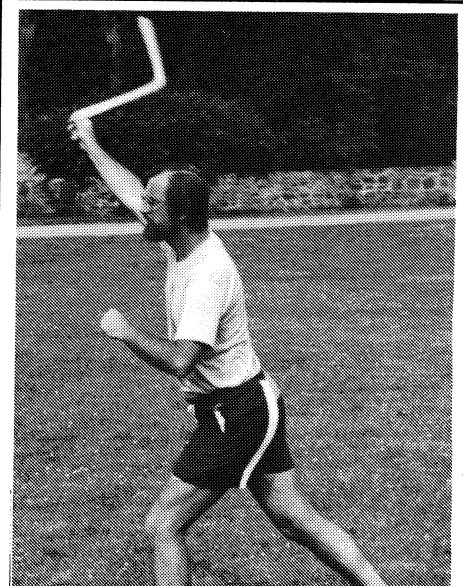

JOHN DERDEN

The 1988 USBA Nationals

by John Koehler



The USBA Nationals were held in Allentown, Pennsylvania. Peter Ruhf did a fantastic job as organizer for the big event of the year.

The room and board for most folks was held at the Moravian Academy, only a mile or so from the throwing field. Built in the early 1700's, the Academy is a beautiful place with lots of trees, and old buildings, and a pool.

The big event on Friday night was the USBA auction. Gary Broadbent did a great job getting folks to come up with extra cash. Over \$1000 in cash was raised for the USBA Treasury. Thanks to Gary and all those who donated and bought booms to make the auction a big success.

The competition started the following morning with Peter rounding up all the competitors and giving a presentation on safety and rules. Peter laid out the order of events to match the wind patterns for that time of the day instead of starting out with the traditional consecutive catch event. The weather was very nice with calm but variable winds which picked up in the later part of the day.

The first event was Endurance. The calm winds of the early morning provided excellent scoring opportunity as Koehler took an early

overall lead with a score of 59. Chet Snouffer and Rob Parkins tied for second with 50 catches each.

The second event was doubling. The excellent weather conditions combined with the improved skills of top U.S. throwers gave way to a time consuming event indeed. Chet Snouffer won the event with a marvelous 47 catches. Koehler was second with 43 catches. Rex Grasso caught 35 for third place. Eight year old Adam Ruhf caught 4 and came in tenth.

Juggling, as the third event, went to Chet Snouffer with 39 catches. Barnaby Ruhe popped into the scoring with 32 for second; and Koehler, Sabrie, and Larrance tied for third with 9 catches each.

Fast Catch followed in near ideal conditions with World Record Holding John Flynn demonstrating a nearly perfect 19.20 second round to capture first place. Right behind was John Koehler with 21.23 seconds and Chet Snouffer with 21.56 seconds for second and third places respectively.

MTA₁₀₀ was the next event with some great throwing by some new names in the MTA placing categories. James McLemore from Louisiana was new to the sport and popped up a Bailey midi-MTA for a time of 42.69 seconds. John Koehler followed with another Bailey midi-MTA to take the lead with a score of 49.01, just shy of Doug DuFresne's world record of 49.39 seconds set last year in Gaithersburg at the International Team Cup. John Derden surprised himself as he stepped up with a Bailey maxi-MTA, that was freshly tuned by Gary Broadbent, and threw for a new world record mark of 50.67 seconds.

At the conclusion of the first days events, John Koehler held a narrow lead over Chet Snouffer with overall totals of 46.0 points and 43.5 points respectively.

Accuracy was the first event of the following day with less favorable winds prevailing. Dennis Joyce

took a first place with a score of 38 points by under throwing a Bailey Fast Catch Boom. Chet Snouffer, Mike Forrester, and Larry Ruhf all tied for second with a score of 34 points each.

Australian Round followed as the second event of the day with Mark Legg from Delaware, Ohio tearing up the competition with a Snouffer Black Rose Rang to clinch first place with a score of 70 points. John Flynn followed closely with a score of 67 points for second place and Ken Reed following John with a score of 62 points.

The last individual event was consecutive catch. Greg Snouffer dominated the field catching 9 in tricky conditions. Chuck Smith and Dennis Joyce tied for second with 7 catches each.

The individual events were over with Chet Snouffer narrowly winning over John Koehler with scores of 52.35 points and 50.50 points respectively. John Flynn finished third overall with a respectable 33.00 points.

After the individual events came three team events with nine 4-man teams with names like Bozo, Web town, and Team Gel. Team Midwest won the Team Relay event as well as the Team Position event. The final team event was the new event called Team. One team member pops an MTA up while the other 3 team members do as many fast catches as possible before the MTA is caught. Michael Girvin sent his MTA boom up to heaven where it hovered like an angel for more than 50 seconds. His Gel Team caught more than 40 while the MTA floated to earth. That is, to put it lightly, a new world record! A great way to end the Nationals.

It was a weekend like no other. A great get together for all the competitors and supporters who came. We all look forward to the 1989 Nationals which are tentatively scheduled to be held in Los Angeles in August, 1989.

TOP INDIVIDUAL SCORES FOR 1988 NATIONALS

<u>Consecutive Catch</u>	<u>Score</u>
Greg Snouffer	9
Dennis Joyce	7
Chuck Smith	7
John Koehler	6
Mike Forrester	6
Michael Girvin	6
Gary Broadbent	6

Fast Catch

John Flynn	19.20
John Koehler	21.23
Chet Snouffer	21.56
Eric Darnell	22.12

Australian Round

Mark Legg	70
John Flynn	67
Ken Reed	62
Greg Snouffer	61

Accuracy

Dennis Joyce	38
Chet Snouffer	34
Mike Forrester	34
Larry Ruhf	34
Chuck Smith	33

Endurance

John Koehler	59
Chet Snouffer	50
Rob Parsons	50
Jim Jordan	45

Doubling

Chet Snouffer	47
John Koehler	43
Rex Grasso	35
Michael Girvin	25

Juggling

Chet Snouffer	39
Barnaby Ruhe	32
John Koehler	9
Jacques Sabrie	9
Casey Larrance	9
Mike Forrester	8
Michael Girvin	8
Larry Ruhf	8
Gary Knudsen	8

Maximum Time Aloft

John Derden	50.67
John Koehler	49.01
James McLemore	42.69
Jacques Sabrie	36.74
Barnaby Ruhe	36.01
Chet Snouffer	35.84
Jim Sprague	35.07

OVERALL PLACEMENT AT THE USBA NATIONALS

<u>#</u>	<u>Name</u>	<u>Pts.</u>
1	Chet Snouffer	52.35
2	John Koehler	50.50
3	John Flynn	33.00
4	Gregg Snouffer	27.50
5	Mike Forrester	24.50
6	Dennis Joyce	23.00
7	Jacques Sabrie	22.35
8	Barnaby Ruhe	20.00
9	Michael Girvin	17.00
10	Rob Parkins	16.85
11	Mark Legg	16.50
12	Ken Reed	15.00
13	Chuck Smith	14.50
14	Eric Darnell	14.00
15	Gary Broadbent	11.75
16	Rex Grasso	11.50
16	Larry Ruhf	11.50
18	John Derden	11.00
19	Gary Knudsen	9.50
20	James McLemore	8.00
20	Ron Tamblyn	8.00
22	Jim Jordan	7.85
23	Gary Lemothe	7.50
24	Casey Larrance	7.00
25	Sam Gottlieb	6.25
26	Daniel Ducharne	4.50
27	Jim Sprague	4.00
27	Peter Ruhf	4.00
29	Mole Man	3.50
30	Alan Winterrowd	3.00
31	Saunders Shaw	2.50
32	Clark Springer	2.00
33	Adam Ruhf	1.00
33	Paul Sprague	1.00
33	Andre Haddad	1.00
36	Leigh Barry	0.85
36	Bob Leifeld	0.85
36	John Wilcox	0.85

13th Annual Portland Rose Festival

by Ted Welker

Dean Kelly took third overall with a win in accuracy & a second in MTA₁₀₀. Thomas Peterson, A.K.A. the boomerang bandit, captured second overall with seconds in consecutive catch & fast catch. The overall point differential between 3rd & 2nd was a slim 0.25 points. Top bean was Doug DuFresne with firsts in Australian Round, Consecutive Catch & Fast Catch. Tim Schallberger won MTA₁₀₀ with a 47.06 second flight.

Novice Freestyle was won by Mark Tomseth in the 16 and under class while Charlie Graham took first in the 17 and over category.

Herb Smith of Sussex, England entertained the audience & competitors with cannon-armed distance throwing demonstrations.

A special thanx to Mrs, Marjorie Gerrish who generously sponsored Herb's visit to the Pacific Northwest. and who sponsors this annual event.

Thanx also to the friends and families who volunteered their time & talent.

Marjorie Gerrish adds:

My 13th tournament was most successful on a lovely sunny day. Had throwers from British Columbia, Washington State, California & all over Oregon.

Herb Smith arrived from England and stayed with me for a week. He was the hit of the show and put on several long distance demonstrations.

I had gold, silver, and bronze medals (Olympics) on blue, red, and yellow ribbons (Australia).

The Team Gel Diaries From Evergreen State College

by Michael Gel Girvin
photos by Kurt Williams

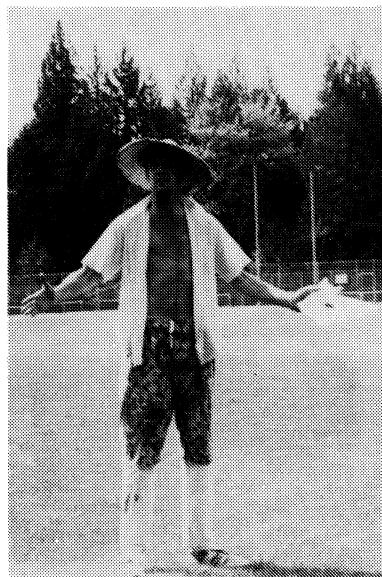

Michael Girvin orchestrates his
last boomtest at Evergreen

The following diary excerpts provide insight into the work and play of the chapter of Team Gel at The Evergreen State College.

Wednesday, April 14, 1988.

The new issue of "Many Happy Returns" arrives at Michael Girvin's house and announces the date for the California Boomerang Championships in L.A.:
May 15, 1988

Thursday, April 15.

Team Gel members ask each other "How in the gel are we (poor starving students) going to get down to L.A.?"

Friday, April 16.

Michael and Steve Kavanaugh mastermind the concept of Boomathon.

"All right then, each person who wants to go to L.A. will throw 500 times in a row and we will get people to pledge a certain amount of money for each catch completed."

"Bitch'in!"

Paul Kimball writes up a proposal and Michael types it up.

April 17-23.

Gelers gather signatures and pledges.

Sunday, April 24.

L.A.-bound Gelers assemble on the dark and gloomy boomerang field at Evergreen and prepare to throw 500 times.

The wind blows hard against our booms as the first toss is launched. Only one person catches.

"Do you really think we can get to L.A.?"

The rain begins to fall during throw 50 and by throw 75 the rain is deleterious.

"The Boom-Gods must not like us, but we won't let them stop us! Onward!"

And then, the sun peeks through the clouds, and by throw 200 the sun graces our boom-filled sky.

"We might just make it!"

By throw 250 the wind replaces the sun and by throw 300 the rain once again soaks us.

"It's cool."

At throw 400, severe winds and more sun play with our booms. Our arms hurt. 450 brings more rain that prolongs the home stretch, 475 -- only 25 left. The wind -- 480. The rain -- 490, 497, 498, 499, 500.

"I guess we're going to L.A."

"We ARE going to L.A."

April 25-May 3.

Collecting is not easy.

Tuesday, May 3.

We buy nine round-trip tickets to L.A. The tickets are non-refundable and non-transferable.

Wednesday, May 4.

Gelers practice hard for the Team Gel Boomtest at Evergreen, May 7 & 8, and the L.A. Boomtest, May 15.

"Two tests in one week?"

"Too rad!"

Friday, May 6.

Michael receives a call from Gary Knudson in L.A. who tells him that the L.A. contest is postponed.

"You mean nine starving students raised enough money to fly down, and you're telling me it's cancelled?!"

Saturday, May 7.

The Third Annual T.G. Washington State Championships are held on Evergreen's sunny boomerang fields. Boomers from California, Oregon, and WA love the sun and throw their booms on the first glorious day since anyone can remember.

A Highlight:

Betsy-Lou Miale steps into the bullseye for Fast Catch. She is the last rad-boomer to throw in this event. Maxxy Belvedere and Rob Greer look on, thinking they have the first and second fastest times. But Betsy-Lou has other plans. She throws her boom, and catches. Throws again, and catches. She rips her third throw too high. She runs . . . "Catch it, Betsy-Lou" Her fingers reach and grab. Catch! Back to the bullseye. Again. Fourth Catch. Only one more. She throws the fifth . . . the boom traverses the air, fast . . . catch, in the bullseye. 31.15 seconds! Betsy-Lou steals the win.

Saturday night, May 7.

Barbecue at Michael's. Tons 'o food.

T.W. Smith, from Eugene, Oregon, reads us his boomerang poetry. The poetry silences the rowdy crowd of boomers with its greatness.

Sunday, May 8.

The second day of competition is held on the same field without the same sun. And Kurt Williams is as gracious as he was the day before because he volunteers, once again, to keep score.

Che Hansen and Andy Gasston, who competed in the novice category, beat all experts in Endurance with a score of 27 catches, in 25 MPH winds! The experts bow in awe and know that in the sport of boomin' there are no categories, only effort and fun!

And then the day ended, and everyone knew that when Casey is up to bat, watch out! Casey Larrance, with four first place wins and two seconds, took the overall tournament victory, and ousted Michael Girvin for the first time in boom competition at this school. (A good omen for the future of Team Gel at Evergreen, since Michael will be going on to grad school at The Chicago Art Institute next year and will not be running the boom club; Paul Kimball and Casey, among others, will run it -- they just will.) Following Casey were Michael, Stevey K., Josh Skov, Maxxy, Jeff Asher, Will Gix, Rob Greer, Mike Krausser, Betsy-Lou, Tom Peterson, Paul Kimball, Scott, Pete Moss, Celese Thompson, Meredith Dean, Ed Love, Betsy Palos, and the list goes on . . . in novice it was

Gary DiDonato who took the win, followed by Che, Lesley Watkins, Christen Gonec, Mo, Georgia, Sharon, Barb, Laro, and more :

Monday, May 9.

Team Gel is going to visit a Boomtestless L.A.

"We'll hand out on Venice Beach and soak up rays and paint the blue sky with our rad booms."

Tuesday, May 10.

Jerry Caplin, the Tournament Director of the L.A. contest, phones Michael.

"When Gary told me that you guys held a Boomathon to raise money, and were going to come all that way I said, 'The test is on!'"

Wednesday, May 11.

Stevey K., Mike K., Becky, Casey, Scott, Lesley, Ed, Maxxy, and Michael are stoked.

Friday, May 13.

Carry-on luggage is searched because lots of funny bent objects are spotted on the metal detector's spy-screen.

The flight attendants wonder where all the paper air planes are coming from, and the captain is awarded 15 style points for three bounces on the landing in L.A.

Saturday, May 14.

Half the Gelters spend the day on Venice Beach pumping iron on Muscle Beach and trading booms for massages. The other half travel out to the valley and visit friends in a house with a pool and tennis court. (They wouldn't let us drive the Rolls Royce, Porche, or Ferrari that were in their garage). After a rough day of training most of us slumber in dreams of booms at Mike "Our hospitably shralping Host" Worth's house.

Sunday, May 15.

"Can you believe we made it here?"

"Are we really here?"

"Thought we weren't?"

"Knew we were!" says everyone in unison.

Highlights:

In Doubling, Casey rips the win with six catches, in bad wind.

Accuracy is conquered by Stevey K's wind-proof precision, his Sunshine Boom, and 24 points.

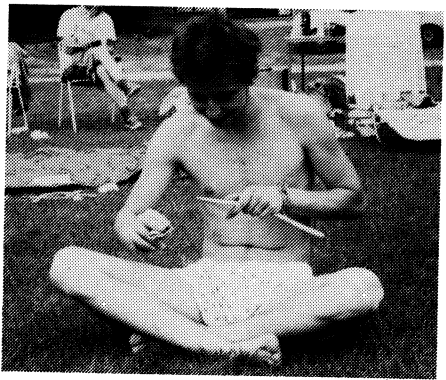

Max Belvedere tunes his boom at the Evergreen boomtest

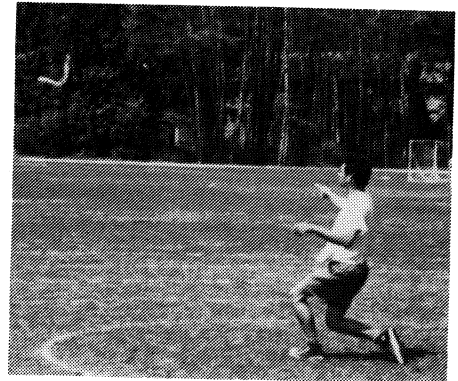

Laro Eisner shreds with the ultimate style-royale

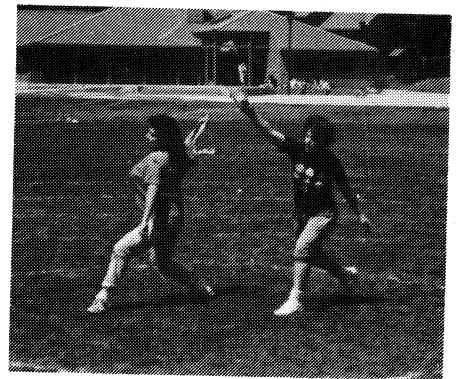

Becky Palos & Celese Thompson get rad in the Bullseye

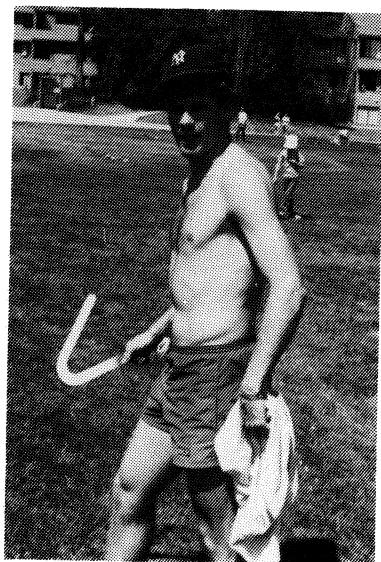

Man of the Week: Casey Larrance First at Evergreen and L.A.

In MTA 100, Maximum Time Aloft, Mike Gel rips a high one that floats off the field and down a four lane street. He catches in the middle of traffic and takes the win in MTAs with 57.93 seconds.

The heat and extreme wind mix with our booms to create a rad time on the boomerang field. We run and jump and dive. We pitch a tent for shade. Fast catch. Accuracy. And MTA. Radness is defined.

As the sun sets and the last event comes to an end, someone says: "Tomorrow we will be doing homework."

At the award ceremonies, Casey Larrance once again amazes himself and takes the over-all honors; other Gels make it into the top ten also. The Tournament Director, Jerry Caplin, says: "Thanks to Team Gel, this contest went down, and was a success!"

And we all say: "Thought it didn't?"

"Knew it did!"

We are all blown away. By the smiles we feel.

1st Annual Southern California Boomerang Corroboree

by Jerry Caplan

The onus has been on the boomerang throwers of Southern California to enter the wellspring of annual regional boomerang throws. This year marked the debut of the First Annual Southern California Corroboree held on May 15th in Thousand Oaks, California. The tournament had a rather ominous beginning, excessive concerns for liability insurance being what they are, all of the available fields being sought were administered by schools or organizations demanding expensive, one day insurance, far in excess of available funds. Caving in to these financial obstacles, the tournament organizers, Jerry Caplan, Gary Knudson, Bob Kley and Alan Craig, had decided to postpone the event even after its publication in the USBA Newsletter. After all, how many out-of-towners could possibly come to Thousand Oaks? It turns out that about 15 came! Who else, but Team Gel and attendant entourage. Having raised money to purchase \$2,000.00 worth of non-refundable airline tickets from Washington state to Los Angeles, word reached the L.A. organizers and an eleventh hour decision was reached to cast caution to the wind and go on with the tournament at a local field. Thus the resourceful and determined GEL-folk as well as a contingent of three throwers from Berkeley lent inspiration to the Southern California Boomerang community and spirited the annual corroboree into being.

The tournament was held according to USBA rules with Jerry Caplan as tournament director, Gary Knudson head judge and Art Caplan of Columbia, Maryland lending support and invaluable organizational skills as score keeper.

Team Gel lent their usual brand of antics and occasional brilliance as in the case of ring leader Gel-Girvin chasing an MTA flight halfway down a nearby two-way thoroughfare with Gel-mates stopping traffic in both directions, enabling Mike to catch a 53.29 second flight for

the day's high water mark. Team Gel took the city of Thousand Oaks by storm. Not to be out done, Gary Knudson, a wizard at fast catch, put his MTA almost into orbit and after a door to door search, ended up retrieving it from a local resident's backyard swimming pool. Unfortunately, neither flight qualified for MTA 100.

Alan Craig, of "Bagdad Cafe" fame, in his debut at competitive throwing took first place in fast catch using a boom of his own design, an exotic African Secretary bird and claimed a time of 34.15 seconds. In a surprise upset youngest competitor Arianna K. Caplan, age 6, was nosed out of top money, but still managed to finish 8 meters from the peg in position to capture third place. Gary Knudson dominated Aussie Round with a score of 75.

Overall, it was Team Gel's superlative Casey Larrance with firsts in consecutive catch, endurance, juggling and doubling who captured first place with a score of 69.83. Coming back after a hiatus from competitive throwing of about a year and a half, Jerry Caplan captured second overall finishing second in accuracy, Aussie Round, position juggling and third in MTA for a total of 64.66. (The facts that Caplan's first cousin was head score keeper and that Caplan personally tallied all the scores are generally regarded as coincidental and fairly inconsequential in his miraculous placement second overall). Third was the inspired and handsomely decked-out- in-original-T-shirt-and Hedda Hopper sun bonnet Michael Girvin with firsts in consecutive catch, MTA and position. His score was 53.83. Alan Craig came in fourth overall and Steve Kavanaugh 5th.

A long day of throwing in the hot California sun more than warranted the barbecue and swim generously hosted by the Craig family, Alan, and Parents Rod and Bev: true boomerang supporters. Prizes were in abundance at the awards ceremony with top honors chosen from exotic designs by Alan Craig and high tech specialties of Gary Knudson.

Thanks to all who helped organize and participate in Southern California's first annual boomerang corroboree.

8th Annual New England Boomerang Corroboree

by Larry Ruhf

The 8th annual New England Boomerang Corroboree was contested during a mild cool day with soft favorable winds and included 26 throwers from all over the Northeast. Contestants were organized into teams (4 per team) and a team format was created for the tournament with 3 team events being contested as well as all 8 individual events.

Team events included team relay, position and for the first time ever, team supercatch, which immediately became everyone's favorite team event. The Ruhe-Ruhf team of Barnaby Ruhe and Peter, Larry and Adam Ruhf won the team championship as the debut of Larry's 8 year old Adam was highly successful.

Barnaby in his accustomed fashion piled up points in most every individual event including firsts in Australian Round and Doubling and 2nds in Juggling and Fast catch to win the Overall Championship with 63.5 points. Peter Ruhf was second overall with 57.25 points and Dennis Joyce came in third with 48.75 points.

Highlights of the day included Dennis Joyce's 20 catches in Consecutive Catch which establishes a new U.S. record in the event and Mike Forrester's 46 points in Accuracy which tied the U.S. record.

Accuracy: Mike Forrester (46)
Peter Ruhf (35) Kris Almqvist (35)

Austral. Round: Barnaby Ruhe (72)
John Koehler (69) Eric Darnell (64)
Dennis Joyce (64)

Consec. Catch: Dennis Joyce (20)
Rob Parkins (10) Peter Ruhf (8)

Doubling: Barnaby Ruhe (11)
John Koehler (7) Peter Ruhf (7)

Endurance: Larry Ruhf (45)
Rob Parkins (44) John Flynn (42)
Peter Ruhf (42)

Fast Catch: John Flynn (21.20)
Barnaby Ruhe (23.38) Larry Ruhf (26.58)

Juggling: Dennis Joyce (20)
Barnaby Ruhe (16) John Koehler (13)

MTA 100: Larry Ruhf (42.66)
Moleman (41.53) Barnaby Ruhe (37.97)

Team Events Evoke Stokedness

by Michael Gel Girvin (condensed)

The Fourth Annual Team Gel Oakland Boomtest went down on the familiar Billy Martin Field, with its familiar bad wind, sun, and diversity of people from Punk Rockers to Church-Goers. 14 novices and 16 experts competed together in all events, and everyone helped each other, and everyone learned from each other. And, as you may well know, the boomerang and the spirit of Team Gel is the proper recipe that when cooked up in sun and wind produces smiles on everyone's face, and fun. But was it fun? No way! It was beyond fun: it was radtastically gaburly and tricked out to the max.

Saturday, July 9th:

In Bad Wind Consecutive Catch, Jake Disston, an amazingly poised new boomer, takes second, without ever having tried the trick catches before. Shifting Wind Accuracy is conquered by four year veteran, Steve Fargon, who is the only boomer to get all five of his throws to land in the scoring zone. Peter "Pay" Rose dominates in Fairly Bad Winds Endurance with his wind Sunshine boom. And then, 15 year boom veteran, Peter Gibson throws an MTA.

Peter rips it high. The boom stabilizes. He runs . . . down the field. The MTA floats up into the sky. Up. Up. Over a building. Peter is trapped between the fences of the building's parking lot. Down. Next to the building. Peter is trapped between the fences of the building's parking lot. Down. Peter jumps onto the second fence. The MTA is ten feet away from Peter, ten feet off the ground. Peter traverses the top of the fence. His foot snags at the top. Peter loses control. He falls, slams, and hangs upside down against the fence, dangling. The MTA lands, uncaught. Gel and Pay help the injured Gibson down. 1 minute and 33 seconds of everyone's life has just elapsed.

The USBA events come to an end and the awards ceremony is held at La Val's Pizza. There are winners, and there are winners, but everyone goes home with prizes -- 45 Gel Booms, some Fang (the band) records, t-shirts, and handsome card awards.

Sunday, July 10th:

Same wind, same sun, and Team Gel Team Events are the order of the day. A hum of anticipation causes smiles and hyperness before Team Blindfolded Accuracy, Aussie Round, Super Catch, Round Rang Relay, Fast Catch, George, and Style Outback are contested. The five teams are ready.

Each thrower in Blindfolded Accuracy wears an empty Schaffers 12-pac box and takes two throws. Team Gelatious, featuring Lesley Watkins, Noah, Alexie, and Gel, score massive points, with bullseyes galore.

Team Aussie Round requires all four members from one team to throw simultaneously from the bullseye. Gary Knudson, Jennie Hamiter, Joe Siegel, and Peter Gibson make up Team Flake. And they throw from the bullseye, but do not flake -- they relate, to the flow of the wind and score big.

In Team Super Catch both Paul Kimball's and Gel's MTAs fly right out of the park and onto the same roof. But it is Team B-Town, with Brij Lunine and Matt "Rad", who keep their MTAs in the park and catch the most.

Round Rang Relay is ferociously dominated by Team Gel Studs. Paul Kimball, Kenny Marfcelous (Novice), James Harris (Novice), and four year Oakland veteran, Daniel Harris, do not drop one as they run at near the speed of light. The over used word, awesome, is what they are.

In Team Fast Catch, all teams throw for one minute and catch as many as possible. Team Lazy Sticks . . . catch the most.

Team George is hard-fun. Besides the core six trick catches, team members must attempt a Head Catch, Body Catch, Calf Catch, Hand Over Fist Catch, Butt Catch, Genital Catch, Bottom of the Foot Catch, Behind The Head Catch, Wrist Catch, Stand Up Food Catch, Slap Boom With Hand and Then Catch, Kick Boom With Foot and Then Catch (Hacky Catch), Bounce Off Your Body and Then Catch, and Neck Catch. Team Lazy Sticks . . . catches the most in this event.

Then the Fourth Annual Team Gel Oakland Boomtest came to an end as the sun set and the smiles radiated. More prizes were given away, and people knew that the stokedness in their hearts made them feel great, and that the Team Events were too much fun.

"If you win, you win; and if you loose, you don't. Stay Rad."

Archaeo-look Boomerang

by Craig Kittredge

How do you make a new boomerang look old? . . .Mmm . . . by crackling (a process discovered while browsing through a craft magazine).

The technique of crackling is simple and quite impressive. All that is required, is Franklin Hide Glue, Gesso, acrylic paints, and Antique Glaze by Delta.

Step 1: Cover boomerang with Hide glue. I prefer pouring a thin strip of glue on the boomerang and spreading it with a 3-by-5 piece of paper. However, brushes can be used. Let dry until glue is tacky.

Step 2: Paint boomerang with Gesso. As the Gesso dries, the crackling process will begin.

Step 3: Paint boomerang with acrylic paint. Gesso is ultra white, so, a cover coat is needed. An antique white cover is excellent. After cover dries, paint on any designs, stripes, etc. as desired.

Step 4: After paint dries, cover boomerang with the antique glaze (follow the directions on the jar). Antique glaze is available in many shades. For that dirty-artifact-archaeological-find look, I use Hommel #4007.

Polyurethane is not necessary. The hide glue acts as a sealer.

Several design techniques are available from craft magazines. Such as 24K gold leaf for inlay, mother of pearl inlays, stencils. I've obtained a nice set of English stencils of an elephant, giraffe, and zebra.

I hope you benefit from these few suggestions and "many happy returns"



THE OHIO TOURNAMENTS
DELAWARE: AUGUST 6
CLEVELAND: AUGUST 7

by *Chet Snouffer*

Local throwers held sway over the weekend in the Free Throwers 9th Annual Boomerang Tournament and the Northeast Ohio Boomerang Open near Cleveland. The two tournaments, held annually back to back on Saturday/Sunday in August draw more throwers from across the country than any other regional tournaments in the US. This year 40 competitors threw in the Free Throwers Fling, while 30 competed in Cleveland on Sunday.

Starting with Free Throwers Saturday at the Delaware Water Treatment Park, Columbus' Gary Genheimer won the Novice division, followed by Bud Pell of Detroit and Aaron Ackerman of Belleville, OH.

In the advanced open division, Delaware's Chet Snouffer won the overall with 84.5 cumulative points in the 8 events. Cleveland's Gary Broadbent won 2nd with 50.3, followed in third by Delaware's Gregg Snouffer with 48.3. Toledo's Ted Bailey was 4th overall. Local thrower and boomerang craftsman Rick Tilford placed 9th overall taking 2nd in Consecutive Catch with Gregg Snouffer. Chet Snouffer set a new national record of 40 catches in Consecutive Catch. In the other individual events, Gregg Snouffer won Maximum Time Aloft with a 36.88 second throw, and Broadbent and Portland Oregon's Willy Gix tied for first in Doubling, with 5 catches each. Chet Snouffer swept the remaining six events on his way to the overall victory.

Throwers traveled from Oregon to Massachusetts, Michigan, Kansas, Missouri, Indiana, Illinois, and across the Buckeye State for the event, which took place under nearly ideal

weather conditions.

On Sunday, the winds were up a bit and tricky conditions prevailed at the Cuyahoga Valley National Recreation Area Tournament. The competition was better balanced as well, as numerous throwers split the top spots in the events. Chet Snouffer continued his winning ways with first overall, winning the Fast Catch, Endurance, and Juggling events, for 70 points total. Gregg Snouffer moved past Gary Broadbent as they traded positions, Snouffer taking second Overall, and Broadbent third. Gregg won the Australian Round and the Doubling Events. Newcomer Paul Miletto won Accuracy with 32/50 points. Maximum Time Aloft went to Roger Perry of West Australia with 43.87 seconds in the air! Consecutive Catch went to Willy Gix of Portland and Jacques Sabrie of Athens, OH.

All of the competitors scores go into the U.S. Boomerang Association's computer rating system, utilized to rank all of the throwers in the nation, similar to USTA and other sports ratings systems.

For local brothers Gregg and Chet Snouffer, the tournaments served as a final tune-up prior to their participation on the United States "Red" Team in the 2nd International Team Cup which takes place in France, Germany, and Switzerland in August. Members of the defending Champion Team Midwest, the Snouffers feel good about the way their throwing is peaking just in time for the Team Cup. The Red Team also features World Cup Members Barnaby Ruhe of New York, and Eric Darnell of Vermont, along with Maryland's Ron Tamblin and Oregon's Doug DuFresne. They will be up against a strong U.S. Blue Team, as well as French, German, Swiss, and Australian National Teams in Europe. Cumulative points over a three match series will determine overall team champions.

INTERNATIONAL
TEAM CUP # 2
HIGHLIGHTS

USBA Red Team member Eric Darnell called in the following accounting of the Second International Team Cup that took place in Europe this year. A more detailed accounting will be presented in the next issue of Many Happy Returns.

John Flynn travelled to Europe a little early to test out the weather and participate in the Swiss Nationals (Zurich) on August 13/14. John set a new world record in Endurance with 67 catches.

A week later, he beat his own world record with 70 catches (this included 2 drops) in the first Team Cup Open tournament in Geneva. The overall winners of the first open test match were (1) Rob Croll of Australia, (2) Chet Snouffer of USA, and (3) Eric Darnell of USA. Team Red (USA) took first place overall at the first team match besting Team Blue (USA) by only a single point.

The second open tournament was held in Weinheim, West Germany on August 23. Americans swept the top 3 overall places. Chet Snouffer was first, John Flynn was second, and Barnaby Ruhe finished third. Barnaby Ruhe finished first in Endurance with 63. Chet Snouffer did 61. The second team match on August 24 was dominated by the German home team. Team Blue finished second (ahead by 1 point overall at this time), and Team Red finished third.

The test series moved to the French town of Evry. The open tournament was contested on August 26. Uli Konzelmann of West Germany dominated the day's events taking first place overall. Michael Gel Girvin from Gel Land finished second overall and Barnaby Ruhe from the USA finished third. At the conclusion of the days events, Barnaby Ruhe did an incredible 646 juggles, certainly the most impressive catching feat of all time. John Flynn, not to be outdone, demonstrated a round of fast catch with the stupendous time of only 17.1 seconds. Torstein Frederich, a 17 year old from West Germany demonstrated a round of 18.2 seconds. On August 28, Team Red dominated the last team match in incredible high winds taking all events except Super Catch and scaling the overall victory. Team Blue finished second for the day (and overall). Team Germany finished third for the day (also for overall).

1988 SWISS NATIONALS

The 1988 Swiss Nationals were held in Zurich on August 13/14. The conditions were excellent on August 13 as 52 throwers from West Germany, Switzerland and the USA competed in Accuracy, Australian Round, Fast Catch, and Endurance. Ahn Kim and the Swiss Boomerang Club organized the two day event at the Greifensee Sports Center. Michael Siems of West Germany took first place overall honors. Uli Roos, also of West Germany, took second overall, and Kasper (The friendly host) Kramis of Switzerland took third overall and to assume the title of 1988 Swiss Champion. John Flynn took advantage of the calm afternoon conditions to set a new world record in endurance with 67 catches (with 2 drops) in 5 minutes (*editor's note: How did Flynn take 2 firsts and a second with only 4 events and not place in the top 3 overall?*).

The second day featured exhibitions and demonstrations. Highlights included a doubling duel between Flynn and Croll; as well as a consecutive catch showdown between Behrens and Roos. Volker Behrens winning the duel with a no hands/no feet catch.

TOP PLACEMENT SUMMARY

Consecutive Catch

Michael Siems	11/12
John Flynn	10/12
Roland Krug	10/12

Aussie Round

Arthur Rueckert	75
Klaus Huerzinger	74
Uli Konzelmann	70

Fast Catch

John Flynn	21.96
Uli Roos	23.33
Michael Siems	23.91

Endurance

John Flynn	67
Uli Roos	57
Arthur Rueckert	57

FIRST ANNUAL St. LOUIS TOURNAMENT

The first annual St. Louis boomerang tournament was held on September 10 on a field adjacent to the hosting St. Louis Science Center. The morning focussed on a workshop for making boomerangs with Tom Fitzgerald, Ted Bailey, Chet Snouffer, Roger Perry, and volunteers scrambling to teach 50 novices how to make and throw a boomerang in a 2 hour span.

The afternoon tournament was dominated by ugly winds as only 5 out of 22 competitors managed to make all five catches in the fast catch event. The best fast catch time was 33.67 seconds by Chet Snouffer. Gregg Snouffer dominated consecutive catch with 13 magnificent catches in terrible winds. Jim Schramm topped Accuracy with a score of 27. Chet Snouffer had a magnificent Australian Round with a first place score of 76. Roger Perry dominated MTA₁₀₀ with a fabulous first place time of 37.12 in strong winds. Ted Bailey had a 1 min. 21 sec. flight that left the circle for a no count. Chet took doubling with 13. Greg Ross took juggling with 5 catches. Overall winners were (1) Chet Snouffer, (2) Roger Perry, (3) Gregg Snouffer, and Mark Legg and Chicago Bob tied for fourth place overall. Spirits were higher than the scores as the group thrilled the crowds gathered to watch the first such event ever held in that area. Media coverage was great too. Plan on going to the St. Louis tournament next year (to be sponsored by the St. Louis Science Center and the St. Louis Boomerang Club).

BOOMERANG BOUNCES BACK

The Formica Corporation has decided to reintroduce its famous pattern used extensively in the 1950s. The pattern, formerly called the "Skylark", will now be called the "Boomerang" because everyone keeps asking the Formica Corp. for the boomerang pattern. The patterns will be white and pink boomerangs swimming in a sea of white or charcoal. Additional colors will include: hot pink with yellow and blue boomerangs; and bright blue with pink, yellow and blue boomerangs.

STRIP LAMINATED HUNTING STICKS

Melvin Wallace, formally of Tallahassee, Florida is skilled in the construction of strip laminated hunting sticks. These are made out of steam bent strips of attractive American hardwoods, similar to the way Al Gerhards made his attractive boomerangs years ago. He is a transient student at this time and has sent his entire (small) supply of these beautiful boomerangs to Ted Bailey to market for him. If you are interested in obtaining one of these gems at an attractive price, contact Ted Bailey at the ad below.

BOOMERANGS BY TED BAILEY

I have a limited supply of Oceanic and Australian collectibles, as well as strip laminated throw sticks, competition boomerangs, plastic boomerangs and other items of interest to readers of this newsletter. To obtain my price listing, send a request to the listing below:

Ted Bailey
2967 Gracewood Road
Toledo, Ohio 43613

BLUE STAR RANGS



Competition Boomerangs from the birthplace of the Challenger III

- * LONG DISTANCE
- * FAST CATCH
- * 40-METER HEAVY WIND
- * HARDWOOD LAMINATES

Send SAE to:

VOLKER BEHRENS
AM Muhlenberg 11
2407 Bad Schwartau
West Germany

MORE FAIRY TALES COME TRUE

by Ted Bailey

One of the most incredible sights ever seen was Larry Ruhf's eight year old son, Adam, doing a round of fast catch with a 25 second time using a boomerang with a span of almost half his height. He impressed onlookers at the conclusion of the days events at the 1988 New England Corroborree in Amherst, Massachusetts.

Torsten Fredrich of Hamburg, West Germany, at the age of 17, has become the youngest person ever to do super catch. Using a Bailey midi-MTA and his own fast catch design, he performed the feat on his first attempt this year. Torsten has really impressed many of the American craftsmen with superb quality and performance boomerangs that he has made and traded to U.S. competitors.

Fridolin Frost, another German 17 year old, recently broke the MTA minute barrier with a flight of 1 min. 7 seconds. He has done fast catch at 21.4 seconds. Can super Catch be far away?

Barnaby Ruhe and Eric Darnell recently became among the oldest (40+) to do the super catch. Barnaby did his in Australia during the 1988 World Cup with a throw of more than 50 seconds and a sequence of 6 fast catches underneath the MTA. Rob Croll holds the record with a sequence of 7 fast catches. Eric Darnell, who admits that MTA is not his strongest event, finally figured things out at the 1988 New England Corroborree. Easily doing the super catch as Ted Bailey, Barnaby Ruhe, Peter and Larry Ruhf struggled for a sequence of 4 fast catches. His MTA simply stayed up an extra 10 seconds.

Gerrit Lemkau writes to tell us that he did the super catch on September 1, 1987 using a Bailey

Midi-MTA and a DuFresne FC II. He didn't time the MTA but says it was 50+ seconds.

SUPER CATCH HONOR ROLL

Ted Bailey
Gary Broadbent
Rob Croll
Eric Darnell
Doug DuFresne
John Flynn
Torsten Fredrich
Mike Forrester
Michael Girvin
Rob Greer
Thomas Hartmann
Dennis Joyce
John Koehler
Ray Laurent
Gerrit Lemkau
Barnaby Ruhe
Chet Snouffer
Olivier Vouktchevitch

John Derden was surprised at the Nationals when he set a MTA 100 world record with a time of 50.67 seconds using an MTA that had given him lots of trouble until he hit the tune just right. He later wrote the following to Ben Ruhe: *"Believe me, the MTA 100 record and win hit me like a bolt out of the blue. I certainly did not expect it, but it helped salvage what for me was not a very good weekend of competition."*

Gerhard Bertling, who wrote the excellent computer program published in the summer issue has an innovative "New Wave" MTA design that recently provided him with a flight of 1 min. 13 seconds.

Ray Laurent called from South Bend, Indiana on a hot July evening to say he went out to attempt the super catch under ideal conditions. On his first throw with a midi-MTA, he did 40 seconds; his second throw was 46 seconds; his third (and last) warm up throw re-

sulted in a sacrifice to the jet-stream god. The boomerang just went straight up until it was lost from sight at 10 minutes and 15 seconds. I felt sorry for him and sent a replacement MTA so he could attempt super catch. A week later, I received a call where he said after tuning the MTA, his first flight was 1 minute, 4 seconds. On his second throw, he did 1 minute, 18 seconds. On his third throw, he attempted the super catch. He was successful, and his MTA stayed up for a full 2 minutes, 30 seconds.

Chet Snouffer and Mark Legg, both from Delaware, Ohio have been bitten by the fast catch bug. Their most recent design modifications have produced practice times as low as 17.0 seconds. Some of these booms have single pass times of 2.5 seconds but are difficult to catch for a round of 5.

The European theater was host to spectacular throwing in August. John Flynn set a world record in Endurance at the Swiss Nationals in Zurich with 67 catches on August 14. This record did not stand for long as John Flynn shattered the record with an incredible 70 catches at the first team cup open competition in Geneva on August 20. And this was with two drops!! Barnaby Ruhe scored a 63 and Chet Snouffer scored a 61 in Endurance in Weinheim on August 23 during the second test match. The third team cup match was host to more spectacular (post tournament) demos as Barnaby juggled a total of 646 boomerangs before giving up due to darkness. Another 9 catches and he would have bested Rob Croll's consecutive two handed catch record, with a quantum increase in level of difficulty as well. Torsten Fredrich, who is the youngest thrower (17) ever to do the Super Catch, demonstrated a fast catch time of 18.2 seconds. John Flynn said that was the only time he had ever seen this from outside the bullseye. John Flynn finished the day by demonstrating a 17.1 second round of fast catch.

Boomerangs in Music, Literature & on TV

by Ted Bailey

John Mauro, past president of USBA (1985/1986) has completed a new 500 page book on marketing research titled "**The Question Finder**" which sells for \$1,000. John is currently updating and expanding his popular "**Introduction to Boomerangs**". Parties interested in obtaining a copy of John's book can write to:

Smith & Flannery, Inc.
P.O.Box 10366
Richmond, Va. 23225

Garry Lamothe sent in a copy of the June 1988 issue of **Yankee** magazine which featured Eric Darnell and his home based company: "Turning Point" in a section called "Small Business & Crafts". The August, 1978 issue of **Yankee** magazine featured Eric in an article, written by George Leavens, and titled "Vermont's First Festival of Boomerangs". Collectors would be wise to look for this back issue in old magazine shops to gain a historical perspective on how far we have come in ten years.

The **Cooper Point Journal**, a publication of the Evergreen State College in Olympia, Washington gave Michael Girvin, and his Team Gel following, extensive coverage in their May 25, 1988 issue. The article covered the groups fund raising activities in April and May and tournament results in both L.A. and Evergreen State College.

A **Bargain for Francis** is a third grade reader by Russell Hoban with the following passage: "*Why do I have to be careful?*" said Francis. "*Remember the last time?*" said Mother. "*That was the time you played catch with Thelma's new boomerang,*" said Mother. "*Thelma did all the throwing and you came home with lumps on your head.*"

Australia in Oxford is a publication of the Pitt Rivers Museum in Oxford, England which covers the European perception of Australia as it developed through the eighteenth and nineteenth centuries. There are 114 colour and B&W illustrations. Published in March, 1988, the book can be purchased for L5.95 plus L1.52 P&H surface rate from England to the USA. Check your bank for the ever changing monetary exchange rate. Payment by International money order or postal order can be sent to the following address:

**University of Oxford
Pitt Rivers Museum & Dept.
of Ethnology & Prehistory
South Parks Road
Oxford OX1 3PP
United Kingdom**

Australian Geographic, an excellent Australian Publication covered in the Summer Issue of MHR can be ordered for a yearly subscription rate of \$30 (Australia), \$43 (surface rate overseas), or \$66 (airmail overseas). A back issue costs \$8.50. Add \$3.00 for overseas surface rate and \$9.00 for overseas airmail for back issues. Collectors would be wise to order back issue number 8 to obtain a copy of the extensive article on boomerangs described in the Summer issue of MHR. All \$\$\$ in this paragraph are Australian. Obtain the proper exchange rate before sending off your payment to:

**Australian Geographic Pty Ltd
P.O. Box 321
Terrey Hills, 2084
Australia**

Jim Sasse of Tennessee sent in a full color advertisement by Royal Caribbean featuring a boomerang as one of the few things sold today that has a higher return rate than they do; comparing passengers that come back for a second trip.

Scott Gilford of Toledo, Ohio found an advertisement for Lockheed Aeronautical Systems Co. in the September 1988 issue of **PROCEEDINGS; U.S. Naval Institute** which featured a large color photo of a Bakwood strip laminated boomerang.

Ted Welker of Portland, sent in a copy of the June 20, 1988 issue of **HealthWeek** which featured a boomerang theme advertisement for a computer based course marketed by Blue Cross.

Ted Welker, Tom Peterson, and Doug DuFresne were featured in the **Lake Oswego Review** on June 30, 1988 which covered a demonstration the trio did at the Oregon Museum of Science and Industry.

Little DOT in DOT LAND issue number 39 had a story about Dot giving her father a boomerang shaped pie. When he threw it it returned and hit him in the face.

The **Daily Hampshire Gazette** published an extensive article on the boomerang movement in their August 26 - September 2 issue of **Hampshire Life**. The cover featured a full color front page of assorted boomerang technology and art. The article, written by Richard Matthews, covered the historical development of boomerangs in the USA, as well as a who's who of the movement.

H.L. Mayhew has come out with a new publication called the **Alum Creek Boomerang Club News**. Full of H.L.'s unique talents, the publication can be obtained by sending four 25 cent U.S. postage stamps to :

**THE PUBLISHER
5609 LONGRIFLE RD
WESTERVILLE, OH. 43081**

Watch the PBS Program **DISCOVER** on either November 2 or November 9 for a special boomerang segment on the 1988 World Cup in Australia and on Bluey Roberts discussing and throwing boomerangs.

NEW PRODUCTS

Remember the single bladed tumble stick described in the summer issue of MHR? The Goose Co. has a new version of this remarkable device made out of wood which outperforms the plastic model. Painted red, white and blue, the new model has a range of 10 feet. You can obtain your own for only \$7.95 + \$1.50 P&H from:

The Goose Co.
P.O. Box 18928
San Jose, Ca. 95158

William Harris, President of The Goose Company is interested in making contact with retail outlets (including overseas) wishing to carry his products. He can be reached at the address listed above or by calling: (408)-578-7439.

James Miller of Sacramento, Ca. and Garry Lamothe of Northampton, Ma. have both recommended a cyanoacrylate glue called **Jet**. These glues come in three different formulas with different thicknesses and setting times. Garry Lamothe demonstrated the product to me by repairing a thin MTA with a clean break in only a few minutes. The MTA held strong and true throughout the next days competition. You can buy these products at your local hobby store or order them by catalog. You can obtain ordering information from Tower Hobbies by calling their toll free number: 1-800-637-6050. Tower Hobbies also carries many other fast drying glue products including **6 Minute Epoxy**. This fast drying epoxy is set in only 6 minutes and does not become brittle, even with age. **QUICK SAND** is a super strong Aliphatic glue that takes only 20 minutes for full strength. The finished joint can be evenly sanded after drying.

James Miller of Sacramento, Ca. has found a source for contemporary-**South-West Indian Rabbit Throw Sticks**. North American Cultures, such as the Eskimos and Hopi Indians, used throwing sticks to hunt birds and small animals long before the arrival of the white man. A 10,000 year old throw stick made out of Oak was recovered from a sink hole in Florida 10 years ago. The throw stick maker that James found is a Cupeno Indian from north central San Diego County, named William Pink. The throw stick is called a Luise-

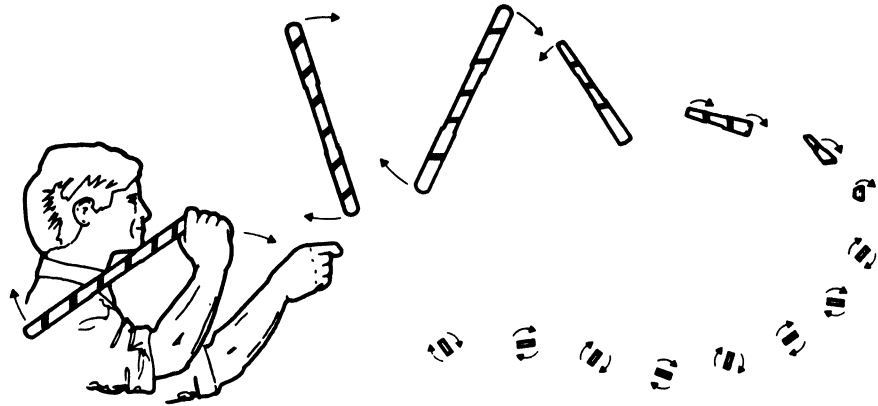

no throw stick and is a natural elbow modelled after a traditional museum piece. Look for more information on how to obtain one in a future issue of MHR.

The editor is always getting interesting mail from contributors. One of the most startling was a recent letter from Greg Nolan of Huntsville, Alabama. Greg is a full blooded Australian Aborigine who is going to Oakwood College on a scholarship. He and his wife Jillian have been in the USA for 4 years and weren't aware of any indigenous throwers until he found a Boomerang Man ad in a Popular Science magazine. Richard Harrison put him in contact with USBA so that we could all share his story.

Greg is a member of the Wiradjiri tribe which is located about 200 kilometers west of Sydney in New South Wales. The ancient art of boomerang making was

passed down to him by his uncle, Don Nolan, who still makes boomerangs in Australia. Greg intends to pass on this family tradition to his children. He has been featured in local newspapers and on a Sunday night sports show called "Weekend Warrior". He has extensively promoted the boomerang in his area and will continue to do so until he returns to Australia in May 1989.

His designs are traditional standard shapes and are beautifully decorated with wood burnings as depicted in the figure below. Parties interested in corresponding with Greg and/or ordering his boomerang art creations can write to him at:

The Boomerang Factory
5014/18 Oakwood Road, N.W.
Huntsville, Alabama 35896
(205)-721-0429

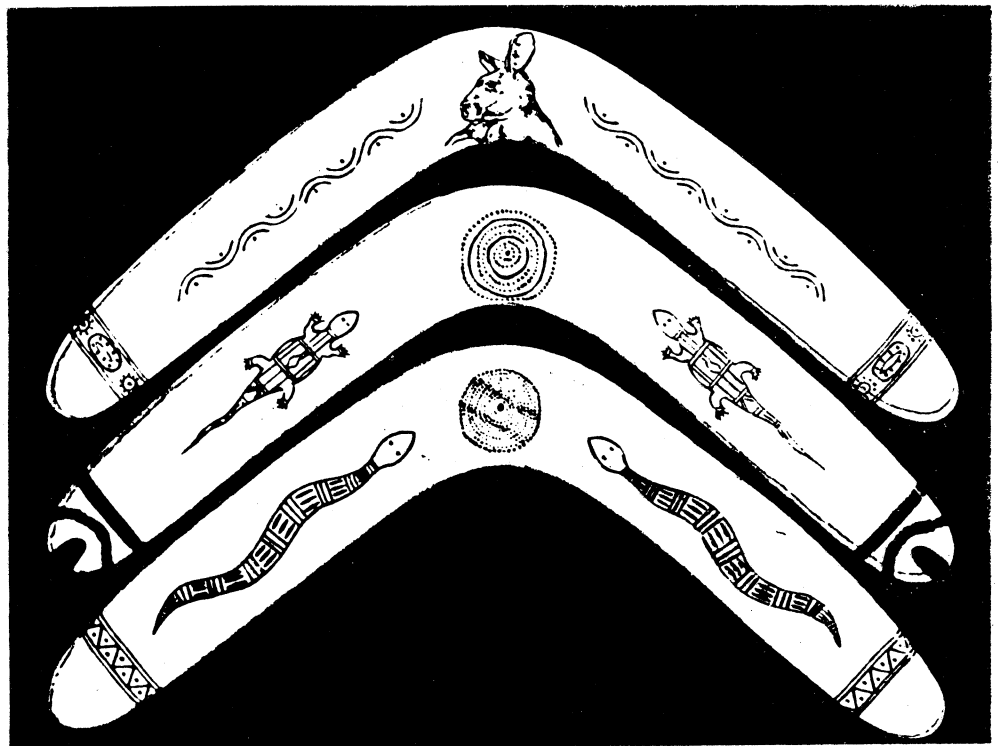

KIDS & BOOMERANGS

Many of the seasoned throwers remember the antics of "Baby Ben" Loveland who took America by Storm in 1984. Well trained as the Grandson of Bunny Read, Ben won an important first place in the Aussie junior division at the ripe old age of 28 months.

Kids in America don't usually hit the news at such an early age, but American boomeranging parents are quietly training their children now to become future champions. Last June, I watched Larry Ruhf release his 8 year old son, Adam, into a tournament of advanced throwers. Although he was blown out during the competition, Adam demonstrated his fast catch abilities by keeping up with Barnaby Ruhe during Team Supercatch and demonstrating an amazing 25 second fast catch sequence (middle right photo) on the sidelines using a boomerang with a span of a third of his height.

John and Patti Koehler are training their new daughter, Kimberly (top center photo), to throw at a very early age of 6 months.

Ray and Callie Laurent have their son Ray Jr. (top right photo) throwing boomerangs at an age of only 3.

Bob Rudy's 14 year old daughter, Paula, used boomerangs as a science project (bottom right photo) in her West Columbia, Texas Junior High School. Her display included a boomerang she made by herself and a paper describing

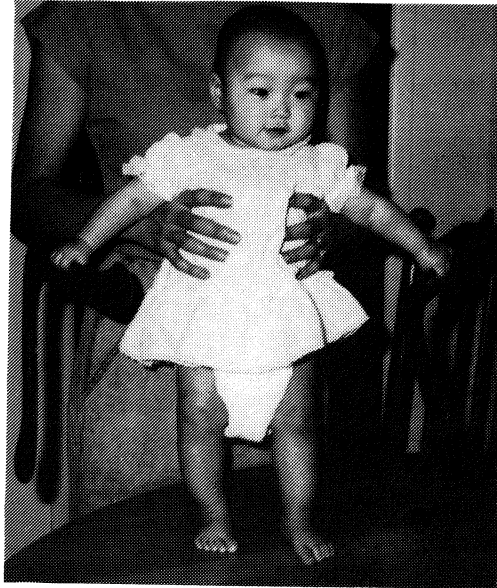

Kimberly with Mom: Patti

how the flight changed with the carving of the airfoils.

Dr. Leziro Marques Silva of the Sao Paulo Boomerang Movement has organized a club of junior throwers (bottom left photo). His son Junior is president. His other son Virucius and daughter Carolina are also in the club. The name of the club is: Associagao de Bumerangas - Itu. Junior is already an accomplished boomerang maker and has even made natural elbow boomerangs with woods from his native country of Brazil.



Ray Laurent Jr.

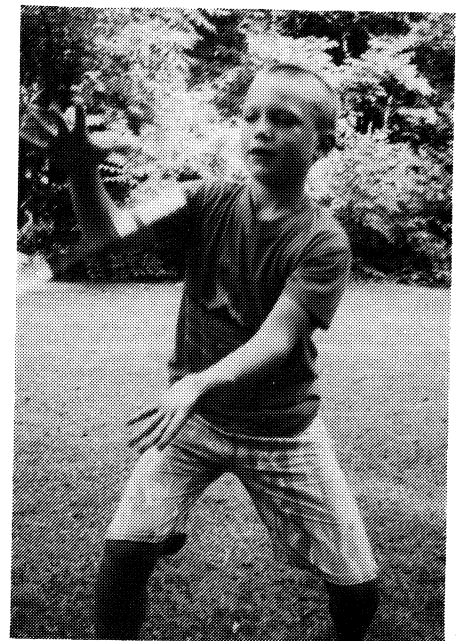

Adam Ruhf makes the catch



The Junior Boomerang Club from Brazil



Paula Rudy and her Science Project

NEWS FROM AUSTRALIA

Bruce Carter, a member of the Australian Boomerang Team, sends the following salutations to the USBA:

May I on behalf of the Australian Boomerang Team extend our congratulations to the first official World Boomerang Champions: The U.S.A.

Your three team members: Chet Snouffer, Eric Darnell, & Barnaby Ruhe were fierce competitors, fine sportsmen & tremendous ambassadors for your country.

These 3 fine men were very helpful to all competitors & their aim above all was to help promote this wonderful sport.

They were terrific in helping us in handling the press, which was set to have a picnic, but ended up quite fair.

These three gentlemen & their lovely wives were terrific company & I for one was very happy to meet them.

Again America, Congratulations & to all members: Many Happy Returns!

Geoff Kennedy, also a member of the Australian team, writes the following:

Congratulations to the USBA team at the World Cup '88. A great team and a fantastic performance. Their combined international experience helped bring them to the pinnacle of world class boomerang throwing.

Something that was more important than the competition at the cup, is the friendships that evolved during the 10 days. It is obvious that a cross bond exists with 'B' throwers throughout the world, regardless of nationalities and politics. To say farewell to our American friends was an emotional experience and I look forward to the years ahead when we can get together again.

NEWS FROM WEST GERMANY

Wilhelm Bretfeld has announced that it is now possible for USBA members in the USA to subscribe to both of the exciting German newsletters from his country. Even non-German speaking boomerang enthusiasts can benefit from the plans, drawings and cartoons. To become a member of the **Deutscher Bumerang Club**, all you have to do is send a contribution of \$2 a month to receive the quarterly **DBC Bulletin**. An additional quarterly newsletter: **Bumerang Welt** is available for an annual fee of \$28. All prices in this paragraph are in U.S. Currency. Both publications can be ordered through Wilhelm at the following address:

Wilhelm Bretfeld
Postfach 3230
D-2000 Norderstedt
West Germany

NEWS FROM FRANCE

Jacques Thomas of "La Perouse Boomerang Club de France" writes to tell of his research into French texts to find the earliest mention of a returnable boomerang:

"**Jacques Arago**, in the early 1820's mentions a device that was thrown with a return in 1820 near Sydney. He does not use the term *boomerang*. **Louis de Freycinet**, who was with Arago refers to a *bomerang* with a throw and return at Port Jackson (Sydney) in 1820. **Lesson**, another Frenchman of the **Dupperey** expedition refers to a *boumerang* in 1824. **Lieutenant Breton** refers to *boomerang* in 1824. There are many references to French navigators to Australia prior to 1850.

New Club in Texas

Bob Rudy is interested in starting a Texas based boomerang club. Bob has been throwing for more than 20 years and only learned about USBA recently. If you are in that part of the U.S.A., you can write for more information to the address below:

Bob Rudy
Rt. 2 Box 219J
West Columbia, Tx. 77486

USA BASED BOOMERANG NEWSLETTERS

Many Happy Returns is only one publication available to boomerang enthusiasts. The newsletter is mailed free to USBA members who pay only \$10 a year (domestic) dues. Help USBA out by having your friends also join. You can send \$10 to:

USBA Membership
C/O Tom Tuckerman
55 Barrett Road #333
Berea, Ohio 44017

The **Leading Edge** is another fine publication of the Delaware, Ohio based Free Throwers Organization. The domestic price is only \$5 a year. You can mail your subscription check to:

Chet Snouffer
51 Troy Road
Delaware, Oh. 43015

The newest newsletter is a publication of the **St. Louis Boomerang Club**. You can subscribe by sending a (domestic) check for \$5 to:

Tom Fitzgerald
1159 Holly River Dr.
Florissant, Mo. 63031

For only \$20 you can get all three publications and be sure to always know what's going on!!!

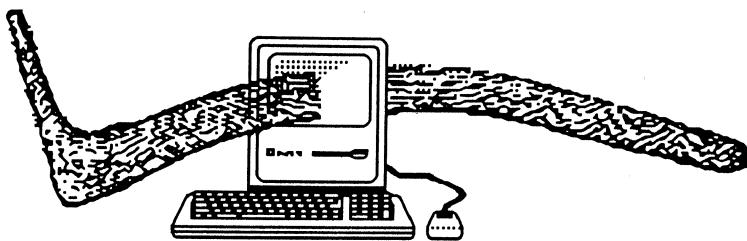

BOOMERANGS & COMPUTERS

Sam Blight of Western Australia writes to give us more information on how he uses computers in the design and development of his fine products:

"I do use a computer (Olivetti M24) running a C.A.D. program in the design process, but this does not include actual flight simulation. It is really just a very efficient way for me to put into practice the boomerang design savvy that I've picked up over the years in order to achieve certain design characteristics.

This is particularly useful for rapidly calculating the area of important flight surfaces and their distance from and effective angle to the boomerang's centre of gravity. The program also allows me to try

and discard a number of possible solutions to design problems without a big cost in time and paper.

At the prototype test stage, incrementally differing versions of the design can be easily generated and tried out and the difference in flight linked to very exact design variations. This process allows me to refine my own knowledge of the relationship of design factors to flight performance.

Finally, if the decision is made to put the design into production, accurate specifications can be quickly prepared for the laser cutting of the jigs we use in the cutting of the plan shape and airfoil angles. This insures that although the final finishing is done by hand, that essential aerodynamic charac-

teristics of each boomerang we manufacture are correct.

Down the track, we are looking at going into moulding in plastic, in which case the model drawings generated on the computer will be used directly by the mold-maker, greatly reducing the expense of producing accurate molds.

Of course, in theory all this could be done with a drawing board, but in practice the ease of use of the C.A.D. package allows me to cover a lot more ground in the design process in a shorter time. The opportunity to easily try out more "lateral" ideas has and will, I feel contribute to better and more innovative boomerang designs."

Wilhelm Bretfeld writes to MHR readers to say that Felix Hess is currently gathering the names of interested parties who may want a copy of a reprinting of his famous PhD dissertation on boomerangs. See last issue of MHR for a description of this classic text. You may write to Felix at the following address if you are seriously interested in getting on a waiting list:



BOOMERANG MAN

1806 North 3rd. RM
MONROE, LOUISIANA 71201

(318) 325-8157

Hours: 10 A.M.-12 Noon & 2 P.M.-5 P.M. (Central Time)

13th ANNUAL FREE CATALOG!

Always something new and exciting!

MOOMBA!!!!

"Giving fast, personal service always."

Rich, The B-Man

"Your satisfaction guaranteed."

Copyright
1987

Dr. Felix Hess
Lab. voor Algemene Natuurkunde
Rijksuniversiteit
Westersingel 34
9718 C.M. Groningen
The Netherlands

DAN RUSSELL

P.O. Box 84895
San Diego, Ca. 92138

Write for a free catalog of
Dan Russell's quality
boomerang products today!

A SIMPLIFIED MICRO COMPUTER ANALYSIS

by Leziro Marques Silva
of Sao Paulo, SP Brazil

The returning type non-twisted boomerang illustrates many of the principles of rigid body dynamics and some aerodynamic principles as well. Based on the project of Prof. Allen L. King (Dartmouth College), and on experimental and specific essays on homemade wood carved boomerangs, we have processed the obtained data and theoretical calculi in a micro-computer (TK-3000, Apple IIe, Brazilian).

Out of forty eight throws, in which we have used two-bladed boomerangs made with masses in the range of 100 - 130 grams and angles between their blades (arms) of approximately 100° - 105° , the outcomes were distributed in four series, condensed in the table at the bottom of the page. We have made our boomerangs of Brazilian woods: Cashew Tree (*Anacardium Occidentale*), Guava Tree (*Psidium Guayava*), Jacaranda (*Dalbergia Nigra*), and Jequitiba (*Cariniana Braziliensis*).

The flights were monitored by topographical equipment and videocassette camera. All the throws

were performed under sunlight (10:00 AM - 03:00 PM), normal breeze to moderate wind.

We applied the modified Barger-Olsson method to obtain solutions to the equations for returning type, two bladed boomerangs of simple design without twist, taper, or slot. The blades of our wooden boomerangs are convex on one side and flat on the other, like some types of airplane airfoils.

According to the simplified analysis, we assumed the blades have uniform cross sections of widths "B", several times smaller than lengths "L", from hub to tip, with angle "Θ" between their arms, as shown in the figure on the following page.

The boomerangs, launched with linear velocity "V" parallel to the ground and in it's own plane, exerts spin velocity "ω" around a horizontal axis. In these circumstances, a resulting lift force causes the (RH) boomerang to move to the left.

In the flight, due to the fact that the transverse air velocity across the forward moving blade is greater than the transverse air velocity across the rearward moving blade, development of a net turning torque occurs that causes the angular momentum vector "L" to rotate counterclockwise.

This torque rotates the boomerang

around a vertical axis with a precessional velocity "Ω". The angular momentum has the following magnitude:

$$A_m = M \omega L^2 (5 - 3 \cos \Theta) / 24$$

where "M" is the total mass of the boomerang.

The path of a well designed two bladed boomerang (ideal) is circular; it's radius "RC" is given by:

$$RC = \{M / (C \times B \times L)\} \times Z / \psi$$

where:

C = dimensionless lift coefficient

$$Z = (5 - 3 \cos \Theta)$$

$$\psi = (7 - 6 \cos \Theta + 3 \cos^2 \Theta)$$

Based on these theoretical considerations and actual experimental data, we have developed the program for the microcomputer as part of our technical study, in progress.

Of course, we are eager to see the works of others, because in Brazil, there is, unfortunately, little knowledge of the subject. Anyone wishing to correspond with the author to help improve our studies can write to the following address:

Dr. Leziro Marques Silva
Caixa Postal 276
13300 Itu, SP
Brazil

TABLE 1 - Experimental Data (average)

<u>Series</u>	<u>Mass</u> (grams)	<u>Width</u> (cm.)	<u>Angle</u> (degrees)	<u>Length</u> (cm.)	<u>Time</u> (sec.)	<u>Max. Height</u> (meters)	<u>Radius</u> (meters)	<u>Wood</u>
1	100.	4.85	100.	30.0	6.7	11.1	13.1	Cashew Tree
2	110.	5.20	103.	32.0	6.9	10.3	12.8	Guava Tree
3	120.	5.00	100.	31.5	6.8	10.0	12.0	Jacaranda
4	140.	5.50	105.	33.0	7.0	10.2	12.1	Jequitiba

Program Listing of Leziro M. Silva's Simplified Micro-Computer Analysis

```

005 REM "AERODYNAMIC ASPECTS OF
      BOOMERANG'S FLIGHT"
010 REM "TWO-BLADED NON-TWISTED
      RETURN TYPE"
020 REM "LEZIRO MARQUES SILVA, GEOL."
030 REM "DECEMBER 16, 1985"
040 REM "SAO PAULO, SP, BRAZIL"
050 PI = 3.1416
060 HOME:PRINT "DATA ENTRY"
070 PRINT "VERIFY THE DIAGRAM BEFORE
      THE DATA ENTRY"
080 INPUT "R = ? (cm)" ; R
090 INPUT "LENGTH OF BLADES (cm)"; L
100 INPUT "SPIN VELOCITY W (rad/sec)"; W
110 INPUT "LINEAR VELOCITY V (cm/sec)"; V
120 INPUT "ANGLES BETWEEN BLADES
      (degrees)"; TETA
130 FI = TETA * PI / 180
140 C = 4.2 * 10 ^ -4
150 U = SQR ( R ^ 2 - L * ( R - L / 4 ) *
      ( COS ( FI / 2 ) ) ^ 2 )
160 INPUT "WIDTH OF BLADES (cm)" ; B
170 T = C * B * L ^ 3 * W * V * ( 7 - 6 * COS ( FI )
      + 3 * COS ( FI ) ^ 2 ) / 24
180 INPUT "MASS OF BOOMERANG (g)" ; G
190 RC = ( ( 5 - 3 * COS ( FI ) ) / ( 7 - 6 * COS ( FI )
      + 3 * COS ( FI ) ^ 2 ) ) * M / ( C * B * L )
200 LM = W * M * L ^ 2 * ( 5 - 3 * COS ( FI ) ) / 24
210 HOME : PRINT "RADIUS OF CIRCULAR
      PATH OF FLIGHT ( m ) = " ; RC
220 PRINT " MODULUS OF VECTOR U = " ; U
230 PRINT "MODULUS OF ANGULAR
      MOMENTUM = " ; LM
240 PRINT "MODULUS OF NET TORQUE = " ; T
250 END

```

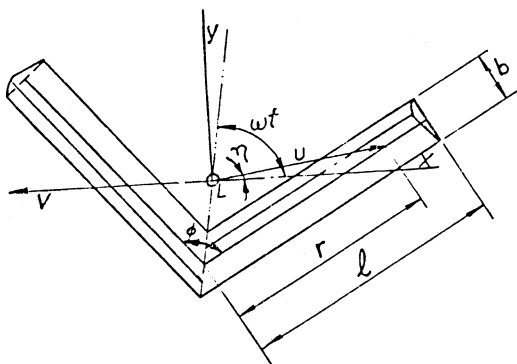

Series #1

Horizontal

Vertical

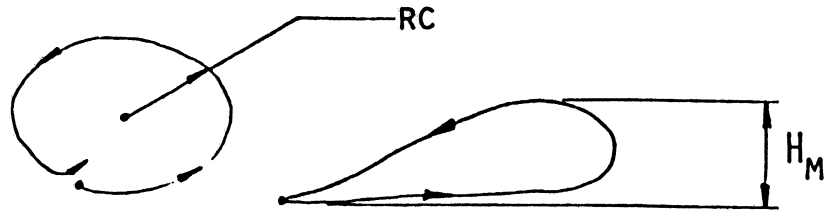

Series #2

Horizontal

Vertical

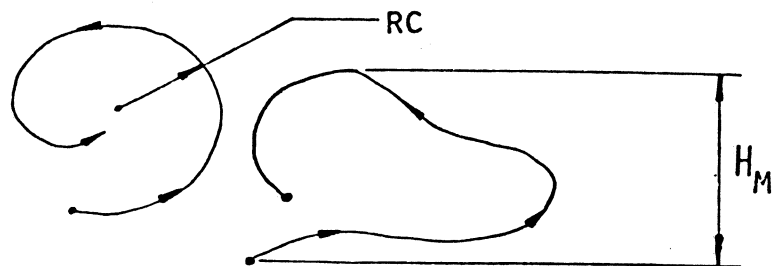

Series #3

Horizontal

Vertical

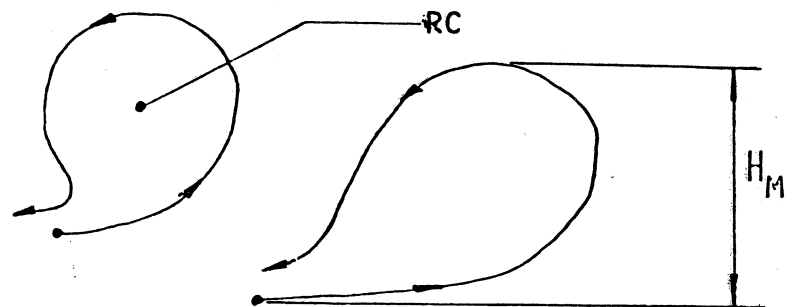

Series #3

Horizontal

Vertical

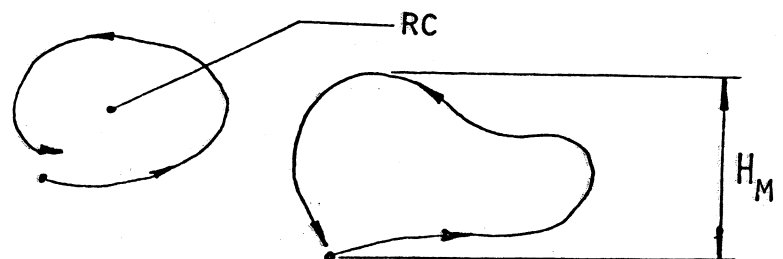

Where: H_M - Maximum Height
 RC - Radius of circular flight path

USBA PRESIDENT'S COLUMN

This summer saw the end of a successful USBA administration under the leadership of **Carmen Snouffer**, and the election of a new administration under the direction of **Dennis Joyce**. The transition has been both smooth and harmonious. The organization remains one of membership committees working together to strengthen our current foundations and expand in new directions. The USBA asks for your support by serving in these committees. Please do not hesitate to contact the committee chairpersons if you have time to help and can be an asset to USBA.

The most important thing that all members can do to help USBA is to bring in new members. A larger membership base is required to support USBA benefits such as a quality quarterly publication, a rating system, a store, various information services, and tournament rules and regulations. **John Derden** is a newly elected board member who is heading up a membership drive committee. If you have any ideas that may be beneficial or if you can dedicate some time to help, please contact John immediately at (912)-237-7207.

Chet Snouffer is the Vice-President this term and has the important task of heading the competition rules and rating system committee. Call Chet to find out who the committee person is for your area so that you can influence the process through proper channels. Chet also has the task of finalizing the site for the 1989 USBA Nationals, and coordinating any efforts that go into international rules. Chet also maintains the USBA mailing address in Delaware, Ohio offering various services such as listings of clubs, wood supplies, manufacturers and distributors. Call Chet at (614)-363-8332 for further information.

Tom Tuckerman retains the position of Secretary this year and is the statistician for the rating sys-

tem and membership listing. You can contact Tom at (216)-234-7407 if you have any questions.

John Flynn maintains his position as treasurer this term with a watchful eye on USBA revenues. John is also active in various other committees such as membership promotion and the rating system. John can be contacted at (802)-296-2158.

Betsy Miale is the USBA legal guru and board member. She is responsible for coordinating USBA legal documents such as the Liability Waivers and Bylaws. She is also helpful in assisting in the interpretation of legal documents such as tournament liability insurance contracts that surface on a regular basis. Anyone who has information on quality, low cost liability insurance or can assist her in bylaw revision committee work can contact Betsy at (206)-774-4774.

Jim Jordan is a newly elected board member and is responsible for the publishing and distribution of the USBA newsletter - Many Happy Returns. If you have problems with the delivery of your newsletter, call Jim at (301)-424-4562.

Garry Lamothe retains his position as USBA board member and is responsible for maintaining the USBA audio and video archival system. If you should capture any good archival material on TV or the radio, please send the original to Garry so it can be added to the archival system. The original will be promptly returned. Garry can also supply you with a listing of items available through the archival system at a low price. Garry has other functions such as working on the bylaws and world records committees. You can contact Garry at (413)-527-9956 for further information.

John Koehler continues his position as board member working on special programs such as helping to bring back the distance event through the rules committee, coordinating a "Master's Tournament", and designing official USBA stationery, a T shirt, and other efforts requiring his special talents. You can call John at (301)-340-1538.

Carmen Snouffer assumes

the position of USBA past president assisting Dennis Joyce in the transition of power and maintaining special functions on her own such as: USBA archivist; working on obtaining sponsorship for USBA International Teams; and documenting current world records for submission to Guinness Book of World Records. Carmen can be reached at (614)-363-8332 if you can provide assistance in obtaining sponsorship or if you have written material that you would like to submit for the archival system. The archives are submitted to the National Air and Space Museum on an annual basis.

Dan Russell maintains the USBA tournament hotline that is published on the outside cover of the newsletter. You should notify Dan as soon as possible when you schedule any kind of boomerang event. Dan can be reached at the address published in his ad on page 15 of this newsletter.

Ted Bailey maintains the position of editor of this newsletter. If you should have any news worthy material for submission or new products for review, you can send all input to him at the address on page 19 or call (419)-471-9989.

ATTENTION BOOMERANG MANUFACTURERS

One service of the USBA is the supply of boomerang product catalogs through: USBA; P.O. box 182; Delaware, Ohio 43015. Chet Snouffer maintains a current stock of boomerang catalogs which are available to members for \$2.00 postage & handling. The cost for this service to manufacturers is free. Simply send a supply of 2 dozen of your current catalog or price list to this address and your product list will be included in each packet of catalogs. Send updated catalogs as necessary. You will receive a postcard when the supply dwindles and you need to send more.

USBA INFORMATION PAGE

Many Happy Returns

Circulation: 1,000 Worldwide.
Published by the:

U. S. Boomerang Association
P.O. Box 182
Delaware, Ohio 43015

Editor/Art Director:
Ted Bailey

Publishing Director:
Jim Jordan

Advertising Director:
John Flynn

Mechanical Measurements:
Image area: 9.5" deep by 7.5"
wide; 3 columns to a page; width
of a column: 2.25".

Advertising Rates:

Full Page	\$200
2 Columns	\$150
1/2 Page	\$115
1 Column	\$80
Per Column inch	\$10

10% discount for four consecutive issues. Camera-ready copy preferred. Composition billed at \$10 per hour. Publisher reserves the right to refuse any advertisement or cancel a contract without reason. Mail all advertisements to:

John Flynn
RR #2 Box 209-8
White River Jct., Vt. 05001

The deadline for advertising is approximately March 1 for the Spring issue; June 1 for the Summer issue; September 1 for the Fall issue; and December 1 for the Winter issue. Early ads with payment will receive the best placement.

NEWSLETTER SUBMITTALS

All submittals to this newsletter should be mailed to the editor:

Ted Bailey
2967 Gracewood Rd.
Toledo, Ohio 43613

The deadline for submittals is the same as for advertising; or whenever sufficient material is received. Material should include print quality art or photos. The editor reserves the right to edit all submitted materials.

USBA VIDEO ARCHIVES

Collecting . . Editing. . Sales

Garry Lamothe
18 St. James Ave.
Easthampton, Ma.
01027

Write for a price listing of selected titles including: historical tournament reviews, scenes from both domestic & overseas shows, scientific, and ethnographic materials, etc.

USBA information and listings are available from the USBA headquarters staffed by Chet Snouffer. For more information, contact:

USBA
P.O. Box 182
Delaware, Oh. 43015



MEMBERSHIP INFORMATION

All membership dues should be paid directly to the membership chairman by check or money order in U.S.A. dollars. Domestic and Canadian dues are \$10 per year or \$150 for life. Overseas dues are \$20 per year or \$250 for life. Check your membership expiration date which is printed on the newsletter mailing label.

USBA MEMBERSHIP
C/O Tom Tuckerman
55 Barrett Road #333
Berea, Ohio 44017

USBA BOARD OF DIRECTORS

President

Dennis Joyce
819 Olive Drive
Newport News, Va. 23601

Vice-President

Chet Snouffer
51 Troy Road
Delaware, Ohio 43015

Treasurer

John Flynn
R.R. #2 Box 209-8
White River Junction, Vt. 05001

Secretary

Tom Tuckerman
55 Barrett Road #333
Berea, Ohio 44017

Directors

John Derden
9 Cole Grove Drive
Swainsboro, Ga. 30401

Jim Jordan
11813 Silent Valley Rd.
Gaithersburg, Md. 20878

John Koehler
37 Dufief Ct.
Gaithersburg, Md. 20878

Garry Lamothe
18 St. James Ave.
Easthampton, Ma. 01027

Betsy Miale
8019 234th S.W. #214
Edmonds, Wa. 98020



**USBA MEMBERSHIP
55 BARRETT ROAD, #333
BEREA, OH 44017
U.S.A.**

PRINTED MATTER

**BULK RATE
U.S. POSTAGE
PAID
ROCKVILLE, MD
PERMIT #4297**

EX: 02/01/90 T:41
Dale W. Riendeau
PO Box 484
Jackson, CA 95642

**USBA TOURNAMENT HOTLINE
(619) 298-4283**

**Please Note that your USBA membership
expiration date is printed on your mailing label.**