

Many Happy Returns

No. 39 \$2.50 An International Publication of the United States Boomerang Association Summer 1989

BERLIN: WHERE EAST MEETS WEST

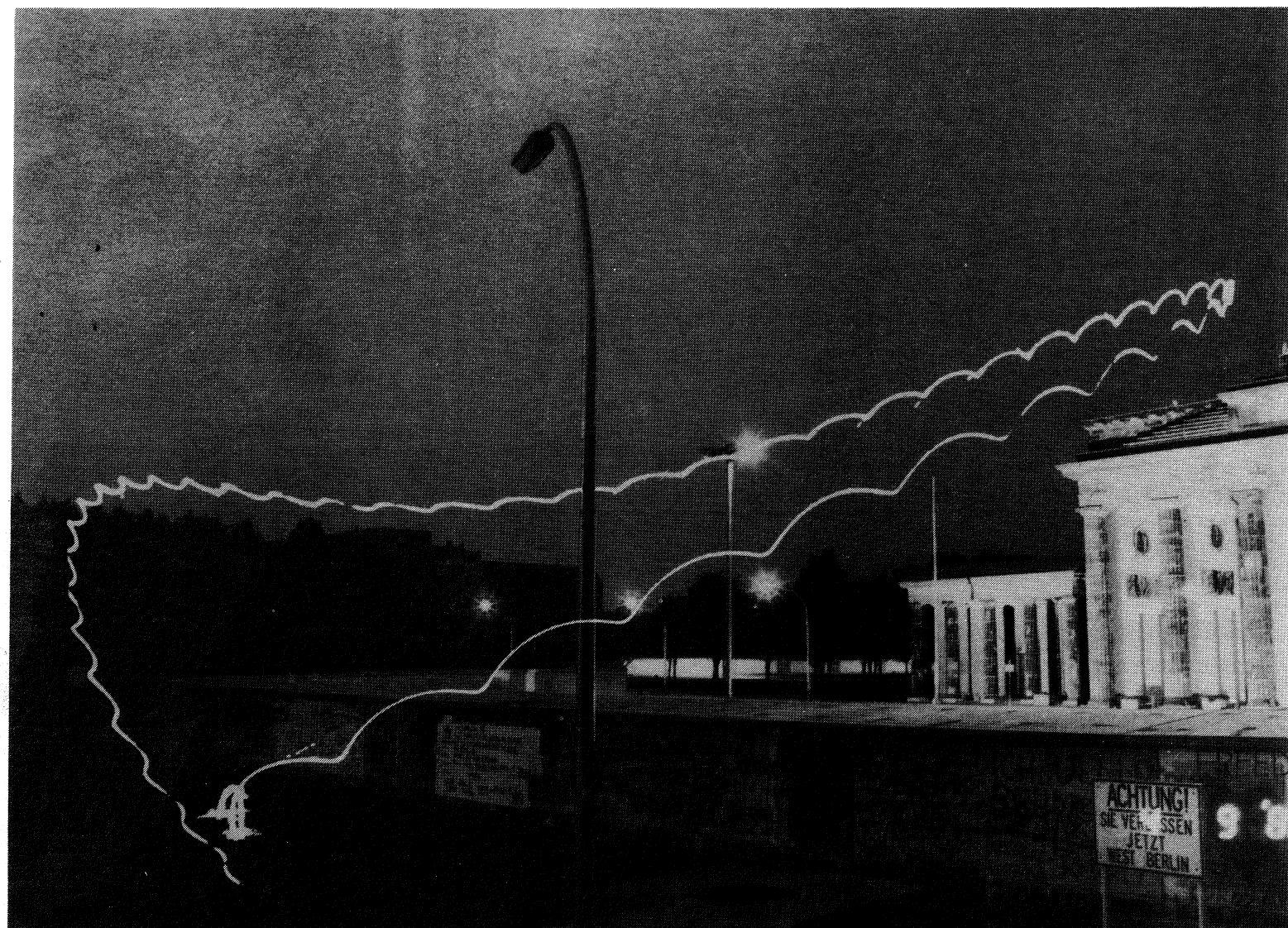

Gerhard Bertling of Berlin, West Germany infringes on Iron Curtain territory using a boomerang equipped with a pyrotechnic flare.



WHAT'S HAPPENING IN THIS ISSUE?

| | |
|----------------------------|----|
| 1989 Tournament Season | 2 |
| International Competition | 2 |
| News from Australia | 2 |
| 1989 USBA Nationals | 3 |
| News from BoomVoid | 3 |
| News from Switzerland | 3 |
| News from the Phillipines | 3 |
| What an Australian Can Do! | 4 |
| Booms in Lit., Music, & TV | 5 |
| A Tool for Tuning MTA | 8 |
| Tuning the MTA | 9 |
| New Products | 10 |
| Boomerang Ball | 13 |
| More Fairy Tales Come True | 13 |
| Team Gel 1989 IBA Comps | 14 |
| Boomerangs & Computers | 16 |
| Boomerangs from Japan | 17 |
| Polar Boomerangs | 18 |
| Boomerang Research Paper | 18 |
| USBA Information Page | 19 |

1989 TOURNAMENT SEASON - U.S.A.

It's time to make plans for the 1989 competition season. The listing in the middle column is the tentative schedule for the remainder of the year. The USBA has a **TOURNAMENT HOTLINE** that can be called 24 hours a day:
(619)-298-4283

June 10 - 18 : Gaithersburg, Md
International Team Cup
June 16 : Ben Ruhe World Open
 Larry Ruhf; 31 Jackson Road
 Belchertown, Ma. 01007
 (413)-323-4340 ; or
 Jim Jordan; 11813 Silent Valley Rd.
 Gaithersburg, Md. 20878
 (301)-424-4562

June 24 : Portland, Or.
 Marjorie Gerrish; 4885 S.W. 78th Ave.
 Portland, Or. 97225
 (503)-292-4316

June 25 : Ft. Wayne, In
 Sean Marquardt
 5415 Old Dover Blvd. #5
 Ft. Wayne, In. 46835
 (219)-486-0503

July 9 : Oakland, Calif.
 Michael Girvin; 4304 N. Ashland #2W
 Chicago, Il. 60613
 (312)-528-4106

July 15 : Meridan, N.H.
 John Flynn; R.R. #2 Box 209-8
 White River Junction, Vt. 05001
 (802)-296-2158

July 16 : Easthampton, Ma.
Webtown Classic Team Comps.
 Garry Lamothe; 18 St. James Ave.
 Easthampton, Ma. 01027
 (413)-527-9956

August 5 : Delaware, Ohio
 Chet Snouffer; 51 Troy Rd.
 Delaware, Ohio 43015
 (614)-363-8332

August 6 : Cleveland, Ohio
 Dave Boehm; Box 17385
 Euclid, Ohio 44117
 (216)-442-6024

Aug. 18, 19, 20 : Gunnison, Co.
1989 USBA Nationals
 Jim Mayfield; 409 North Colorado
 Gunnison, Co. 81230
 (303)-641-3539

September 9 : St. Louis, Mo.
 Tom Fitzgerald; 1159 Holly River
 Florissant, Mo. 63031
 (314)-839-1604

September 17 : Portland, Or.
 Doug DuFresne; 4235 S.W. Crestwood
 Portland, Or. 97225
 (503)-292-4316

INTERNATIONAL COMPETITION

August 5,6 - Berlin, W. Germany
German Nationals

Gerhard Bertling
 Putbusser Strasse 32
 1000 Berlin 65
 West Germany
 (030) 4 63 42 99

August 26,27 - Geneva, Switz.
Fourth Int'l Tournament - Geneva
 Teams from all nations are invited.

Boomerang Club - Geneve
 Case Postale 23
 1225 Geneve
 Switzerland
 Philippe Haake: 022 / 49 99 11
 Kasper Kramis: 022 / 35 64 20

September 9,10 - Evry, France
International Competition.
 Teams from all nations are invited.

Olivier Vouktchevitch
 282, rue Lecourbe
 75015 Paris, France
 16 (1) 45 57 14 07

NEWS FROM AUSTRALIA

Many of the old time competitors remember David Schummy, England's teenage power house thrower of the early 1980's. A frequently asked question in the competition circles is "Where did he go?". The question has finally been answered by Bob Burwell of Queensland, Australia who found David Schummy living in a small town only ten miles north of Bob's home town of Tanah Merah. The distance record isn't safe if he gets one of Bob Burwell's long distance boomerangs in a down under competition. Hopefully, we'll hear more on this later.

John Gibney, Secretary of the BAA writes to inform MHR that Australia will be sending a powerful team to the International Team Cup this year. Roger Perry, who rated high in the USBA system last year will be accompanied by Rob Croll, who always is full of surprises; Geoff Kennedy, Australia's analog to Chet Snouffer; and Steve Moran who is well known for his power and finesse. Good luck to the boys from down under.

1989 USBA NATIONALS GUNNISON, COLORADO

The 1989 USBA Nationals will be a special treat this year as Jim Mayfield, manufacturer of fine boomerangs, organizes a special Friday night and two day boomerang festival on August 18, 19 & 20. This year, the format will be altered from the long lines and extended waiting between throws to give everyone more opportunity to throw, demonstrate, learn from the pros, and have lots of fun with team competition, design and art shows, and night throwing. Bring your distance equipment as you can extend your range by 30% at an altitude of 7700 feet. Special arrangements need to be made for housing and inexpensive transportation from Denver to Gunnison, which is located 200 miles southwest of Denver, so write Jim immediately about your plans to compete this summer. Include how many persons will be in your party. Don't get left out of this one. Contact Jim now at:

Jim Mayfield
409 North Colorado
Gunnison, Co. 81230
(303)-641-3539

NEWS FROM BOOMVOID

The land of BoomVoid lies in the heart of the Midwest with the capital city of St. Anne. Rich Westerman, in his desperation, obtained a listing of boomerang contacts in IL, MO, IN, and WI from the Boomerang Man with hopes of organizing throwers in those states for boomerang get togethers, including the possibility of sanctioned USBA tournaments. Approximately a dozen boomers live in the Kankakee, IL area which sports the ideal terrain of multiple Sod Farms. Think of the potential for MTA or Distance throwing.

One of the local throwers operates a computer bulletin board for the Commodore AMIGA computer with a separate message board for boomerangs. He may open the bulletin service to other computers if interest is expressed.

Roger Perry will be visiting Rich over the weekend spanning July 23. Rich wants anyone interested in getting together with he and Roger on that weekend to contact him at the address below. Also contact him for the possibility of a tournament, throwing session, or for gaining access to the computer bulletin board.

Rich Westerman
RR 6 Box HE 57
St. Anne, IL 60964
(815)-933-4407

NEWS FROM SWITZERLAND

Philippe Haake of the Boomerang Club of Geneva writes to inform us of the successful Super Catch by Matthieu Weber on February 11. Matthieu, who is only 18 years old is scheduled to participate in the ITC this summer. The 4th International Tournament in Geneva is tentatively scheduled for the weekend of August 26-27. The Boomerang Club of Geneva encourages throwers from other countries, especially the USA to visit and compete in a beautiful country with excellent throwing weather. See page 2 for more details. Remember, this is where John Flynn was able to add 10 to the Endurance World Record in 1988.

NEWS FROM THE PHILLIPINES

Erwin P. Brojan of the Philippines has started to take the sport seriously by organizing boomerang throwing as an official community sport in his region. He is conducting a sport clinic for the Municipal Youth and Sports Development Council of Guinobatan, Albay, Philippines. We extend our best wishes to him in his future endeavors and hope to hear more about throwers from his region.

USBA OPEN TOURNAMENTS - 1989 SEASON

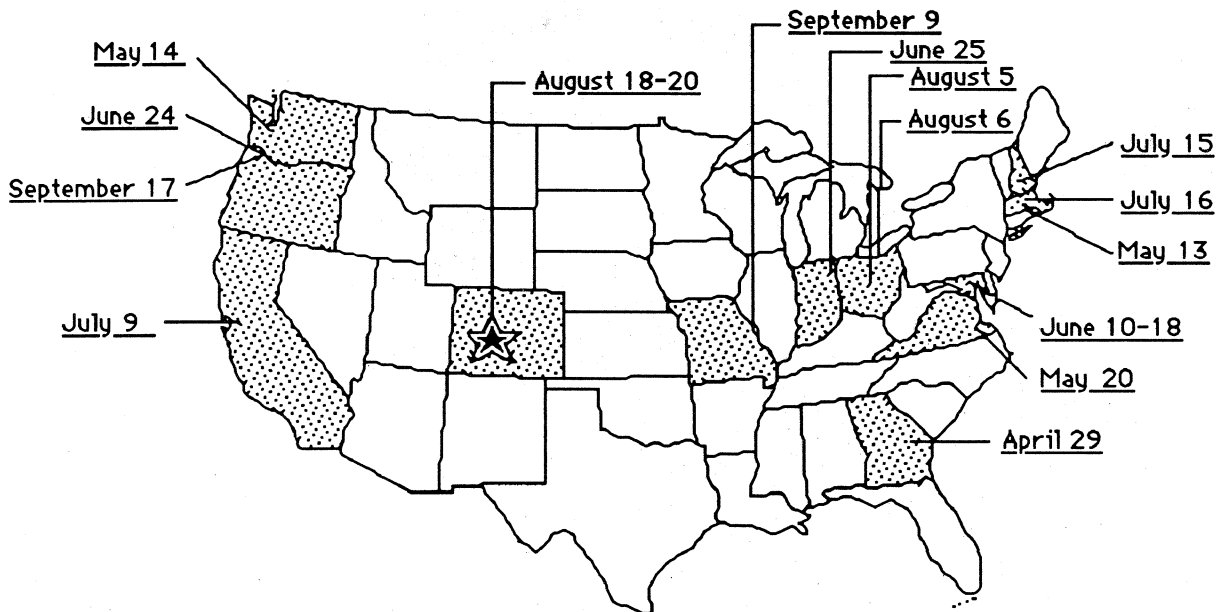

WHAT AN AUSTRALIAN CAN DO WITH A BOOMERANG

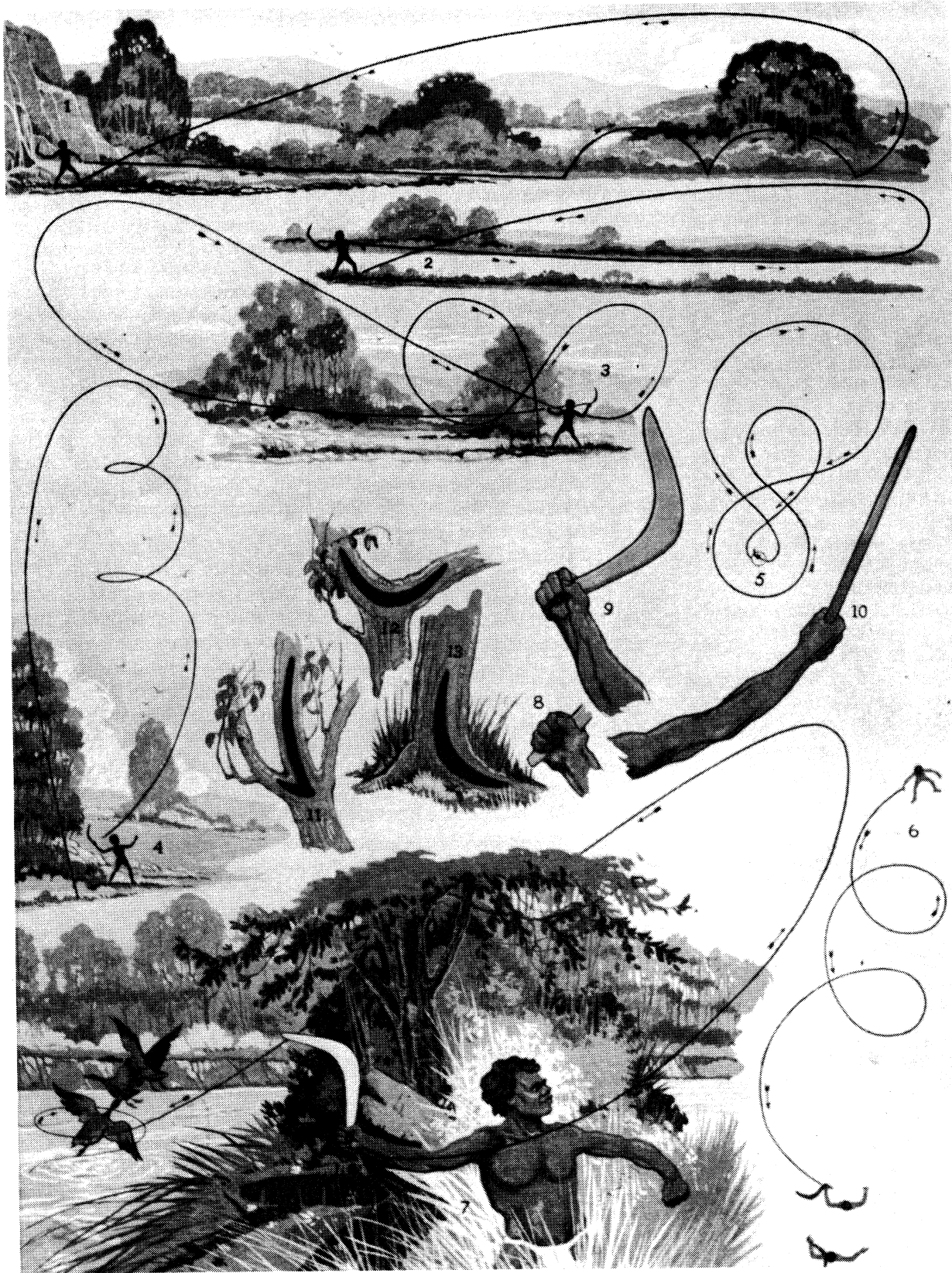

The Australian black fellow makes his boomerangs do many things. In No. 1, he shoots it ahead of him so that it strikes the ground, makes two loops, and then one grand loop back to his feet. In No. 2, it sails through the air and comes back again without touching the ground. In Nos. 3, 4, and 5, it is executing various other complicated maneuvers. No. 6 shows how the boomerang was thrown to hit a foe in battle. In No. 7, a native is bringing down a duck on the other side of a tree. Nos. 8, 9, and 10 show how to grip a boomerang correctly. In Nos. 11, 12, and 13, we see how various types of boomerangs are cut.

BOOMERANGS IN LITERATURE, MUSIC, AND ON TV

Joe Siegel, an Optometrist and USBA member from Sherman Oaks, California received nice coverage in the Nov. 25, 1988 edition of the *Los Angeles Times*. The text was accompanied by several action photographs of Joe throwing and catching a triangle boomerang.

Nick McAuliffe received extensive coverage in the January 5, 1989 edition of *North Shore Magazine*, an Essex County, Ct. newspaper publication. The article which was submitted by the B'Man extensively covers McAuliffe's personal history with the sport as well as interesting tidbits designed to attract the casual reader to the sport. Nick helped the movement by providing the USBA address at the end of the article so that interested readers could establish contact.

John Mauro, past president of USBA has updated his popular text "**An Introduction to Boomerangs**" by issuing the third edition in a large 8 1/2" X 11" format complete with added illustrations, cartoons, and pictures. The booklet, illustrated below, can be obtained wherever fine boomerangs are sold (Boome-

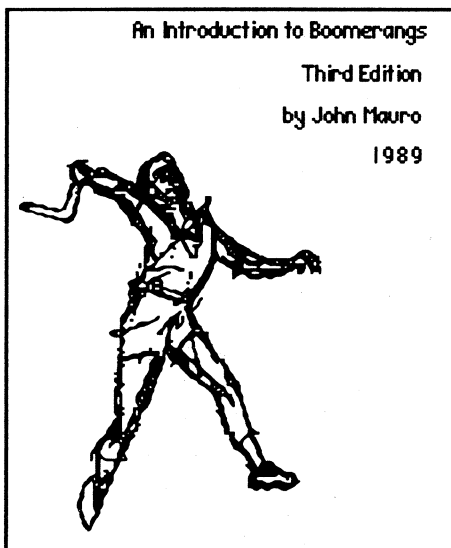

rang Man has them) at a cost of \$5 per copy. Many readers have brought to our attention illustrations in the *Compton's Encyclopedia* that accompany the topic of the boomerang. The illustrations on the previous page are taken from Volume 2 of the 1946 edition of the encyclopedia set. The article states that "The natives (Aborigines) show remarkable skill in the use of this weapon; it is said that they can almost cut a small animal in two at ranges within 400 feet." The skills dem-

onstrated in the figure seem to exceed those of many of our best contemporary throwers. Can these feats really be accomplished?

Peter Ruhf received action photo coverage in the March 1989 issue of *WindRider*, a publication devoted to the sport of Wind Surfing.

Garry Lamothe found a book titled **The American Boys Handy Book**. The book, written by David R. Godine is filled with craft projects similar to those encountered in Boy Scout books. One of the projects is how to make a boomerang. Garry also sent us a copy of the Decem-

ber 18, 1988 issue of *The New York Daily News* which had a nice article on Duncan MacLennan and his Sydney Boomerang School, complete with a photograph of Duncan with some of his boomerangs.

The February 1989 issue of *NASA Tech Briefs* described a device that would be dropped from a spacecraft and allowed to hover down in a spiraling pattern over the Earth or another planet, taking pictures of the ground surface during the descent. The *Samara Probe* (pictured below) resembles a maple seed but the article notes that a second wing may be added to slow rotation and reduce nutation. Is this a good application for an MTA boom? Do any of the readers work for NASA?

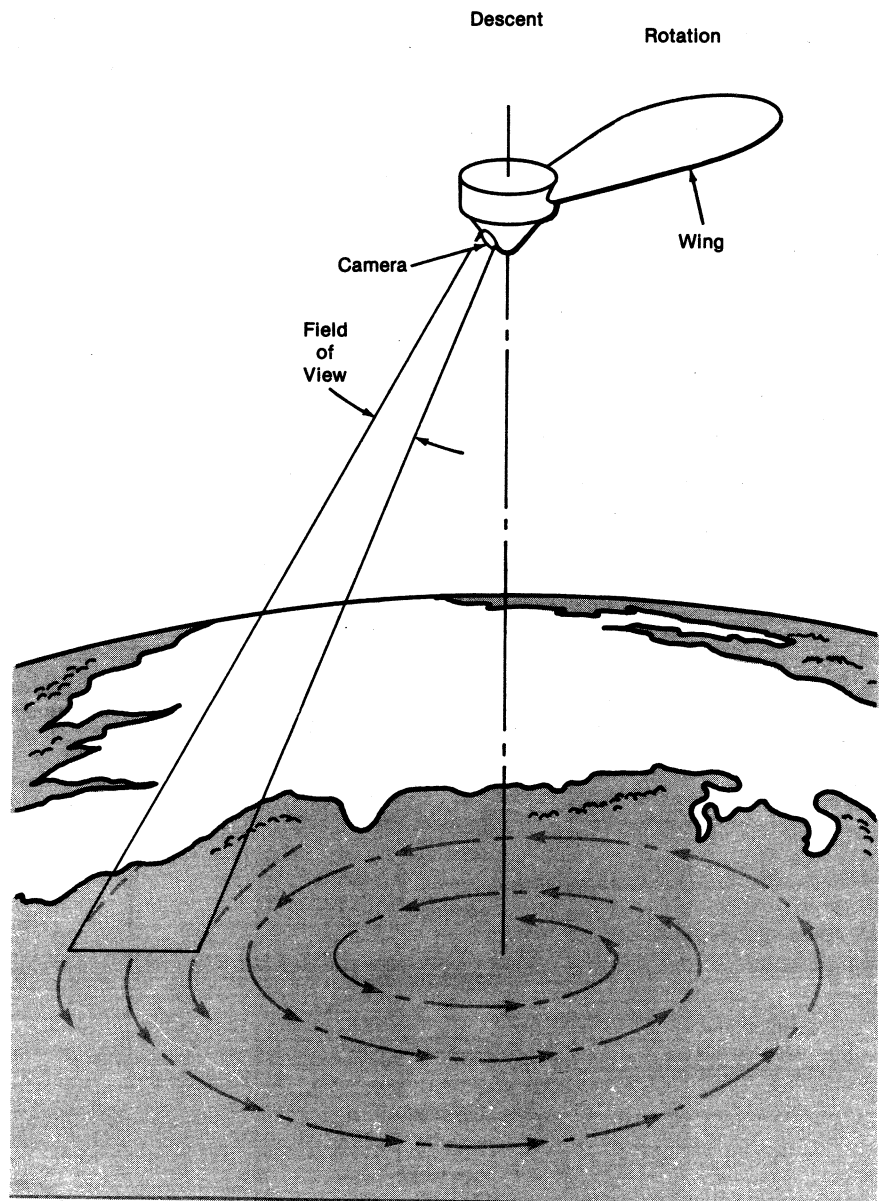

SAMARA PROBE FOR REMOTE IMAGING

Mike Salerno of Topeka, Ks. purchased a quality shirt from a store called "The Brass Buckle" which has a large 5 color logo on it. The logo integrates a boomerang into the design and reads: "Australian (Guess ?) Boomerang Club". The name Georges Marciano is also integrated into the logo. Who can provide insight on where this shirt originated?

Ted Welker of Portland, Oregon found the following quote in the March 1989 issue of **READERS DIGEST**: "Have you ever wondered if whoever invented the boomerang also invented the credit card?"

Ted also found the **GUND** greeting card pictured below. The card was designed by Jim Lienhart and has the message: *Many Happy Returns* within.



Robert Quinn of Holliston, Ma. sent in the following quote that he heard on the **David Letterman** show on February 16: "I learned a very important lesson while out shop lifting in a sporting goods store today. I found out that it's very hard to walk out of the store with a boomerang stuffed in your pants!"

CBS aired a show last winter called *Dolphin Cove* about a displaced American family in Australia. One of the scenes in the introduction features a boomerang with the words: "Gold Coast" painted on the upper surface.

Dave Hetrick of Topeka, Ks. sent in a clipping out of the March 9 edition of the **Topeka Metro News** which says that **The American Heritage Dictionary** is considering including the following word and definition: "**Boomerang Baby** (noun); a gainfully employed young person, typically a college graduate, who chooses to return to and live for an indefinite period with his or her parents; also called 'boomeranger'".

Philippe Haake, of the Boomerang Club of Geneva, sent in a copy of the February 20, 1989 International Edition of **NEWSWEEK**. It contained an article on a new 5-bladed American boomerang called the Bee-Bak. The September 24, 1988 edition of **THE NEW YORK TIMES** also contained information on this unique new boomerang product. Look in the *New Products* section of this issue for more information on what this new boomerang is all about and how you can get your hands on one.

Two television shows, **The Gong Show** and **Truth or Consequences** have a beautiful closing credits scene with a large silver boomerang that flies around Aire's Rock. It's definitely worth seeing.

One of the editor's co-workers brought in a ski trail map for the **Telluride Ski Resort**. One of the trails in the Gorrone Basin is called "Boomerang" because of its overall crescent profile on the map.

Ianto Thornber of Leeds, England mailed in a clipping from the March 30, 1989 issue of **The Independent** which showed a beautiful illuminated boomerang flight photograph. The entry was submitted by Michael Hanson of Scotland in a "Beauty of Physics" contest. The photo, shown on page 7, won first place. Michael set up the photo session and threw the boomerang. The photographer was Christian Taylor and the boomerang was a large model constructed by Bill McGovern of Edinburgh, Scotland.

John Derden and Neil Kalmanson of the East Georgia College have put together an incredible exhibit of boomerangs and related paraphernalia for a month long exhibit in the campus library. The photograph at the bottom of page 7 illustrates the diversity of boomerang technology and art portrayed in the exhibit. John and Neil have received an invitation to put on a summer display at the Georgia Southern College Museum. They are looking for additional art, technology, and historical boomerangs to add to the display. Putting a collection on display is a good way to increase its value. If you have anything that you wish to loan for the exhibit, you can call or write to John Derden at the address below:

John Derden
East Georgia College
237 Thigpen Drive
Swainsboro, Ga. 30401-2699
(912)-237-7831 (work)
(912)-237-7207 (home)

AN IRON CURTAIN BOOMERANG?

Christian Franke of Pfungstadt, West Germany mailed MHR the art for the very unusually shaped boomerang pictured below. The boomerang which has the Russian cyrillics for *Glasnost* and *Peristroika* was designed by Jorg Schlegel. The boomerang has a hammer span of 11 inches and a sickle span of 15 inches. The range is 35 metres in light winds.

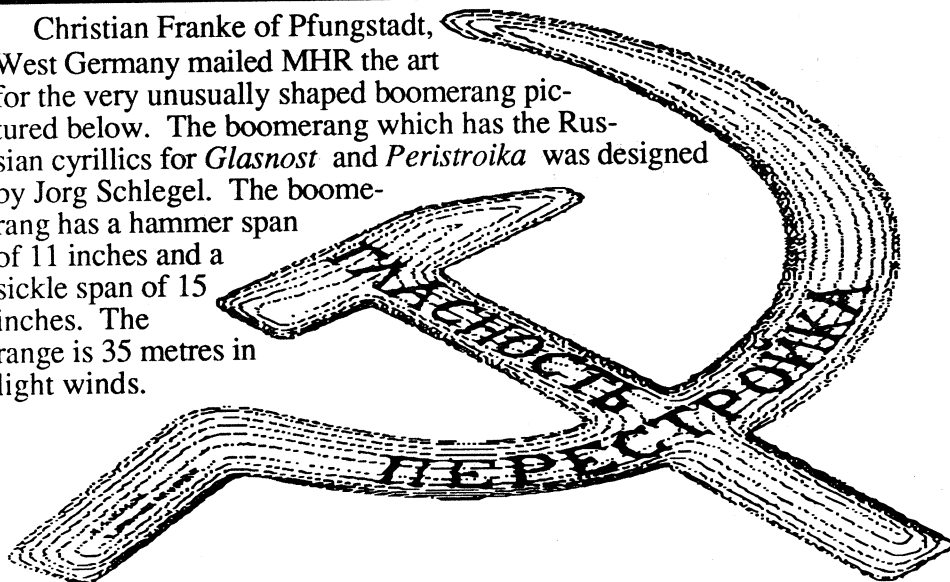

SPECIAL NOTICE

The new 1989 USBA Rules & Rating System Booklet is available through the USBA address below. Members in the USA and Canada may order copies for \$2 each; add 50 cents postage per order. Overseas members can order the booklet for \$5 airmail postage paid.

U. S. Boomerang Association
P.O. Box 182
Delaware, Ohio 43015



Michael Hanson's Award Winning Night Flight Photograph: "Beauty of Physics"



East Georgia College 1989 Boomerang Exhibit

THE DEVELOPMENT OF A TOOL FOR TUNING MTA

Gerhard Bertling, a West German Electrical Engineer, has designed a practical tool for measuring dihedral and angle of attack on a MTA (or any kind of) boomerang. The drawing below depicts the device in position above the underside of a MTA boomerang resting face down on top of a table. The movable right angled feeler arm (resembling a MTA shape) pivots about a small bolt at the convergence of the angle of attack lines near the bottom. A block of wood on the back side of the tool slides up and down on guides to position the gauge at a height providing tangency between the underside of the blade tip and the horizontal portion of the feeler arm. The mark in the slot near the top of the vertical portion of the feeler arm is used to read the angle of attack in degrees. A small centimeter scale is glued on the left side of the tool and is used to measure the dihedral of a blade tip with the underside resting flat on a table top. The figure illustrated below is not drawn to scale or perfectly proportioned. Only a small effort is required to cut the tool backing, feeler arm, and height adjustment block out of a scrap piece of 3mm plywood; drill a hole for the bolt; measure and draw on the angle lines; glue a small ruler on one side of the backing; and glue a height adjustment block guide to the reverse side. The tool is invaluable in quantifying the tuning on a particular boomerang so that it can be retuned easily for competition. The device is also invaluable in making sure that all boomerangs within a given production lot are identically tuned. Innovation also provides an advantage!!!

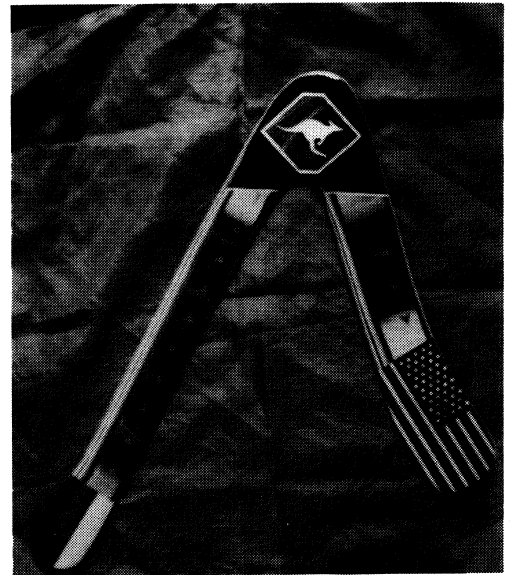
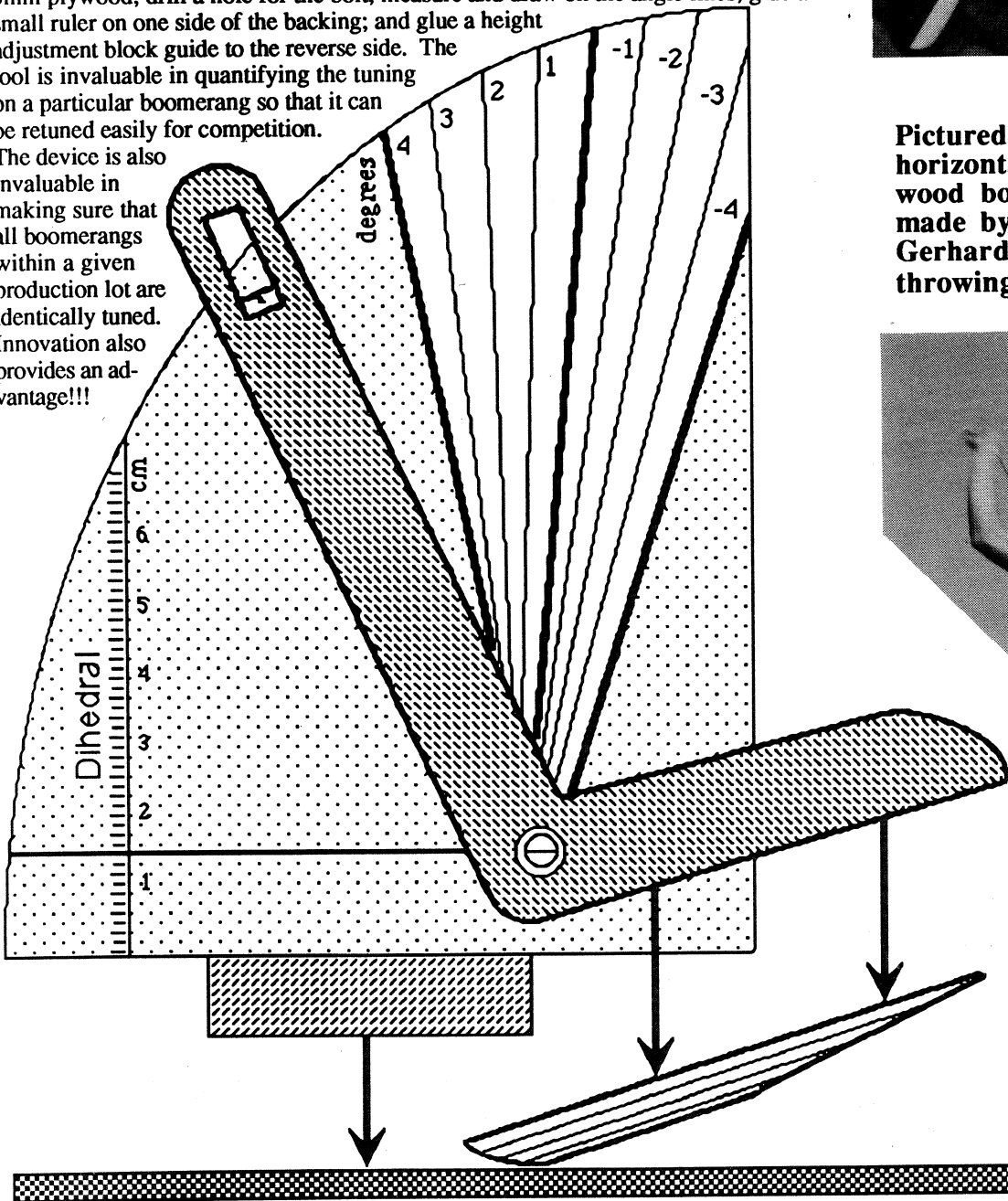

Pictured above is a beautiful horizontally lapped exotic wood boomerang (no paint) made by Gerhard Bertling. Gerhard Bertling is shown throwing in the photo below.



TUNING THE MTA

by Gerhard Bertling

When you speak about "angle of attack", you mean the angle between the flat elbow section and the plane at another section of the arm. But the flying boomerang doesn't rotate with the flat elbow section parallel to the ground. It's orientation is such that it rotates around the axis with the greatest moment of inertia. This orientation is illustrated in figure 1.

Hence, for measuring the *real* angle of attack, put the boomerang with the upper surface face down on a table top and you have the (reversed) orientation of the flying boomerang with the axis of rota-

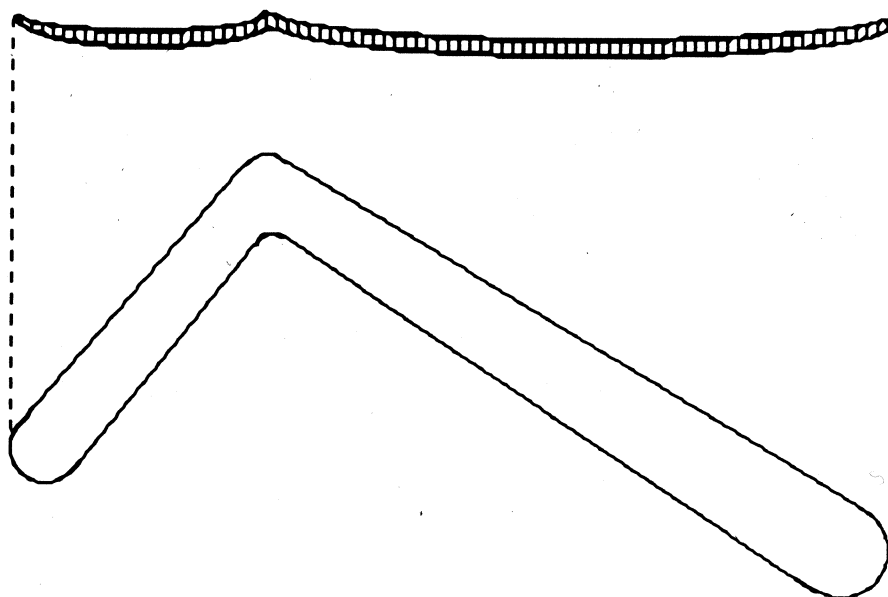

Figure 1 - The boomerang rotates around the axis with the greatest moment of inertia.

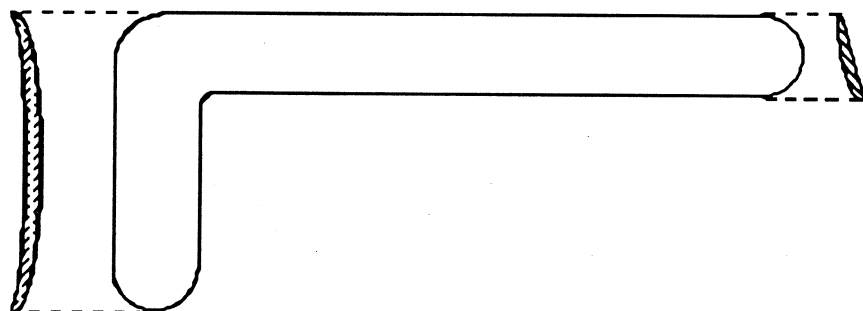

Figure 2 - Dihedral on the lifting arm causes negative angle of attack on the dingle arm.

On Airfoils - I have made several experiments with different profiles but the Bailey MTA airfoil with the sharp leading edge seems to be the best. I had good results with other airfoils (illustrated in figure 4 below) which are said to be useful for low Reynolds Number airfoils, but they are difficult to carve and the advantages over the Bailey MTA profile are not significant. Therefore, I returned to the sharp leading edge and rough under surface found on Bailey MTAs.

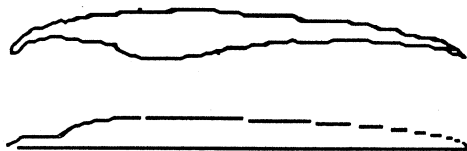

Figure 4 - Other low Reynolds Number airfoils.

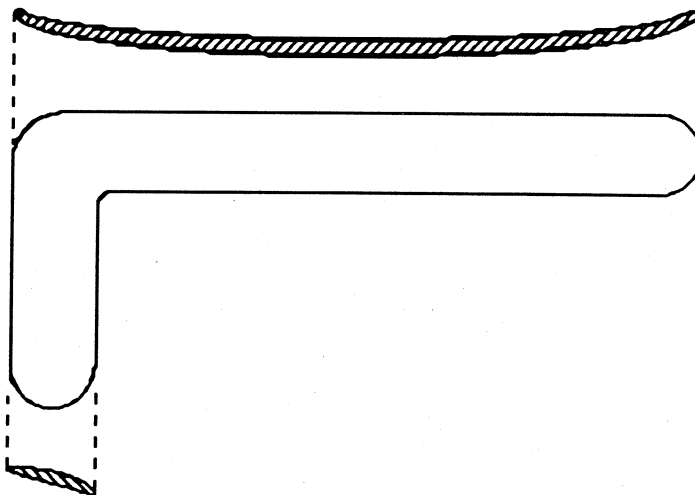

Figure 3 - Dihedral on the dingle arm causes positive angle of attack on the lifting arm.

tion perpendicular to the plane of the table. With my little tool (described on the previous page), it is now very easy to measure the real angle between the boomerang's underside and the plane of the table.

The following conclusions can also be drawn: 1) Dihedral on the lifting arm causes negative angle of attack on the dingle arm. 2) Dihedral on the dingle arm causes positive angle of attack on the lifting arm.

NEW PRODUCTS

Roger Perry of Western Australia has moved from Norseman to Perth and is devoting all his efforts to making boomerangs. He has several competition models with excellent art and finishes. A copy of his price listing can be obtained by writing to his new address below:

Spin Back Boomerangs
15 Thomas Street
East Cannington 6107
Western Australia
Telephone: 451-8879

Beat Aepli's new book on boomerangs titled "BUMERANG" is now available by mail order. This beautiful hard covered text is depicted below. Signed copies are available through Beat at the following address for 36 (+ 5.30 postage) Swiss Francs (appropriate conversion and certified check should be obtained through a banking establishment):

Beat Aepli
Gfeld
CH-9043 Trogen
Switzerland

Readers in Germany can order the book directly from the following address for DM 50 + postage:

Pohhke
Buchvertrieb
Heimbaderstrasse 9
D-7835 Terminger
West Germany

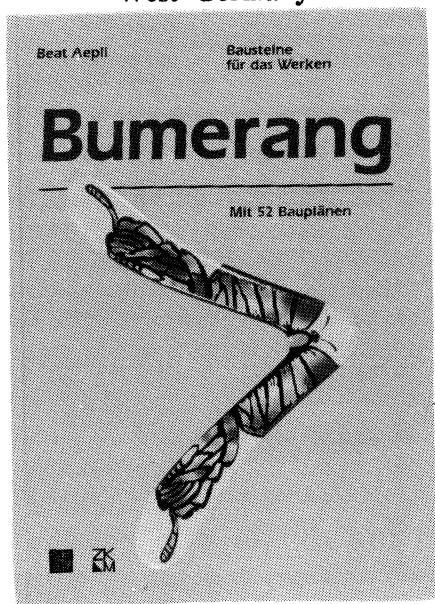

Eric Anderson of **Anderson International Trading** has provided MHR with updated pricing information on their selection of premium grade plywood. "Our Finland Birch exterior plywood is available in 1/4" (60" X 60") 5 ply BU/BU perfect faces at \$.98 sq. ft. or \$24.50 for the panel. Our multi-ply plywood (previously called aircraft plywood) is available in 5.0 mm (61" X 61") 7-10 ply at \$1.95 sq. ft. or 6.0 mm (61" X 61") 7-12 ply at \$2.40 sq. ft.. Both can be shipped UPS when cut in half." You can write and ask for a catalog of these and other fine wood products at the following address:

Anderson International Trading
825 N. Cypress St.
Orange, Ca. 92667
(714)-771-6270

Many of the readers are engaged in the craftsmanship of boomerangs made out of beautiful hardwoods. A source for a large selection of special veneers has been identified at the address below. The editor ordered a sample of several veneers and found almost everything to have rare and desirable fiddleback patterns. One noted exception was *Ebony* which was mottled black and blonde for a truly beautiful pattern. Wood workers in England and Germany can take advantage of their service which includes Mastercard and UPS delivery to Europe at an affordable price. To obtain a catalog of available species, you can call (716)-655-0206 or write to the following address:

CERTAINLY WOOD
11753 Big Tree Road
East Aurora, N.Y. 14052

Stephan Weiss of Miami Beach, Fl. sent in an advertisement for a new flight toy called AirLinks. Polypropylene hexagonal modular units can be thrown separately or linked together by a patented clip & post system in an infinitude of shapes. Created by Blair Atwell and developed by AG Industries with the latest CAD-CAM technology from McDonnell-Douglas Aerospace, the toy was introduced this spring in the Eddie Bauer Catalog for Father's Day. Mass distribution will begin this September. Refer to the Fall issue of MHR for more on this interesting flight toy concept. Retailers may call Greg McCarthy, Production Manager at (206)-885-4599 for more information.

Tom Fitzgerald, founder of the St. Louis Boomerang Club has come up with a beautiful T-shirt sporting the logo below. The T-shirts, available in red, royal blue, green (& other colors) costs only \$10 plus \$2 S&H. Specify S, M, L, or XL at the time of your order. Mention that you read it in MHR and the shipping is free. This offer is for domestic members only. Additional postage charges will be assessed on all overseas orders. Parties interested in purchasing one of these T-shirts can order from the following address:

Tom Fitzgerald
1159 Holly River Drive
Florissant, Mo. 63031
(314)-839-1604

SAINT · LOUIS

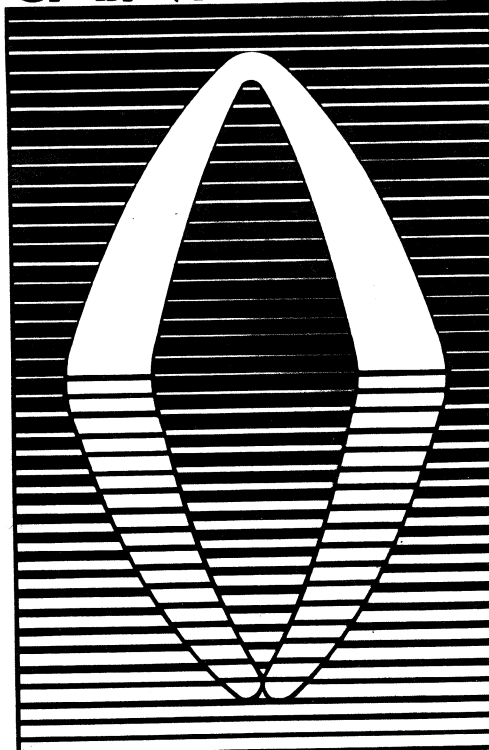

BOOMERANG

C · L · U · B



Ianto Thornber has an unusual product. He makes didgeridoos out of bamboo and hardwoods. Ianto learned to make didgeridoos in Kakadu Park, located in the Australian Northern Territories, east of Darwin. His instructor was an Aborigine named David Canari. His first didgeridoo was made from a piece of bamboo which he found on the bank of a billabong. These beautiful Australian Aboriginal instruments are tuned to specific musical notes. A custom carrying case may also be ordered with each model. Other products, including an instructional videotape on how to play the didgeridoo are available. Ianto's crafts are marketed under the trade name of **BOAB DIDJERIDOO**. A price listing of Ianto Thornber's fine products can be obtained by writing to the following address:

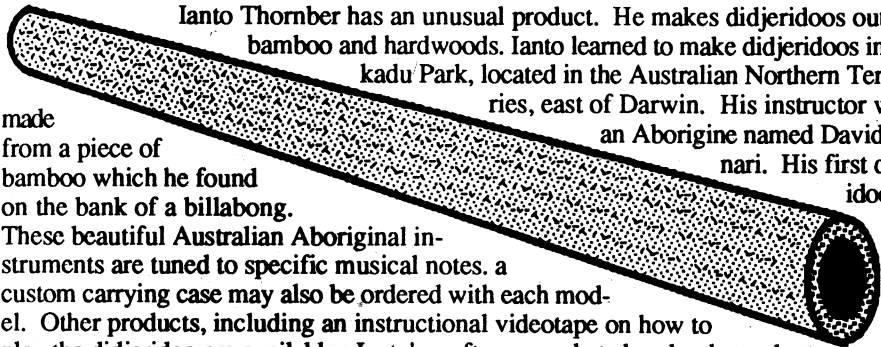

BOAB DIDJERIDOO
 20 Rokeby Gardens
 Leeds LS6 3JZ
 United Kingdom
 (0532) 789437

ALLIED TOY Co.
 305 East 63rd St.
 Kansas City, Mo. 64113
 (816)-363-5114

Allied Toy Co. of Kansas City, Mo. has introduced a new boomerang called the Bee-Bak which retails for about \$7. The boomerang was invented by J Turner Hunt (Patent # 4,772,030), an Aeronautical Engineer at McDonnell Douglas Corp. It has 5 blades, of which four have tips bent heavily upwards; or is it downwards? You see, this one flies like no other boomerang on the market. It flips upside down (or right side up?) in mid flight. It climbs and hovers not unlike an MTA. Refer to the figure below. Many thanx to Philippe Haake of Geneva, Switzerland who sent in the product description from the February 20, 1989 issue of (International Edition) Newsweek. An article also appeared in the September 24, 1988 edition of the New York Times. Parties interested in obtaining wholesale price information can contact Mr. Steven Pack, President of Allied Toy Co. at the address to the left.

**THE FLIP-WING
 BOOMERANG!**

BEE-BAK[®]
 A REVOLUTION IN FLIGHT

The Flight Path

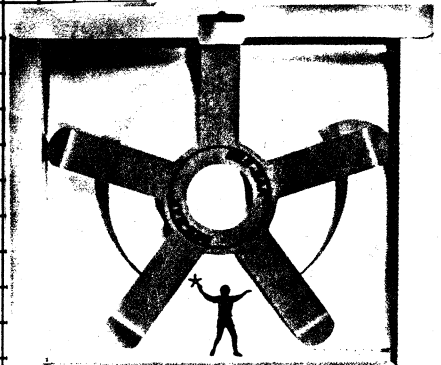
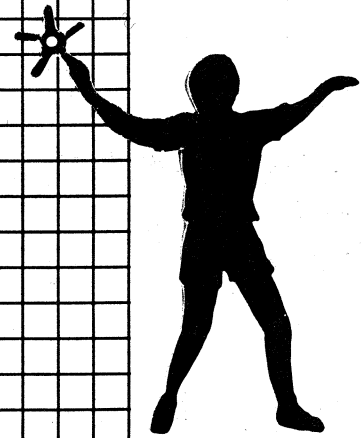
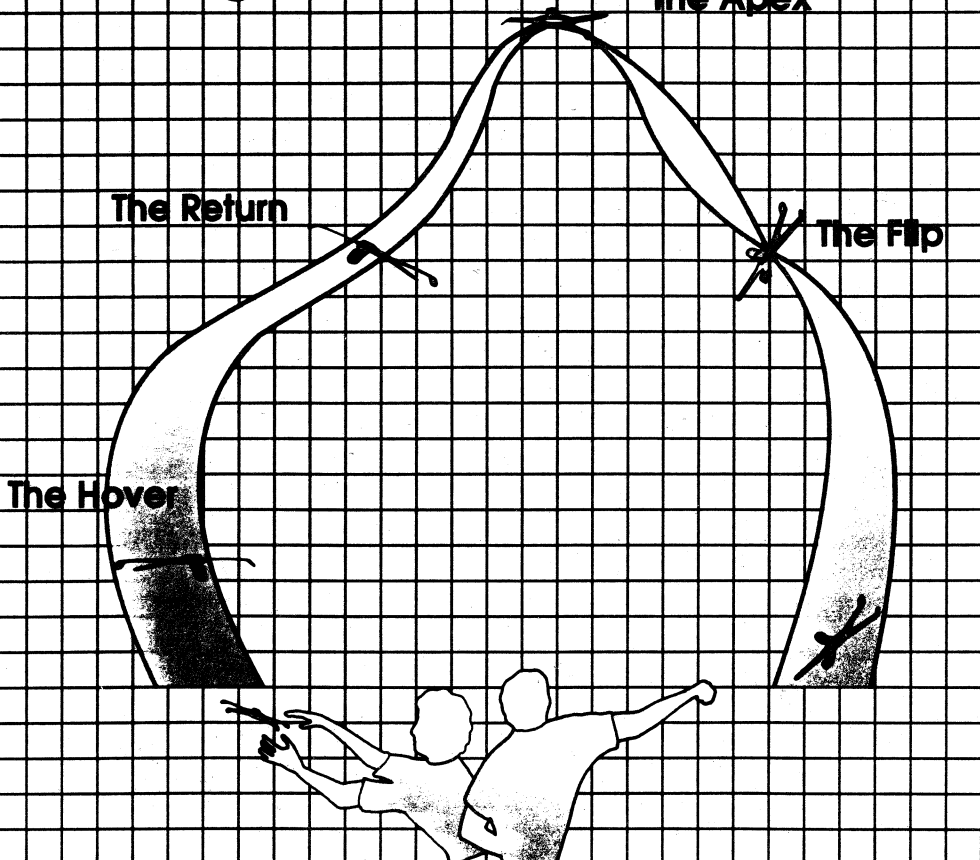

BEE-BAK[®] The Flip-Wing Boomerang
 A Revolution in Flight

Boomerang Man has a new line of products from Minnesota called **Synchronicity Boomerangs**. These boomerangs are terrific flyers with great art. Product plans include derivatives of hooks and omegas in fresh new original shapes. Richard says these are the most exciting new boomerang products on the market in years. He'll have them for sale at the 1989 Nationals or write to

the B'Man at the address below for more info and ask for the new 1989 catalog.

Greg Nolan, an Aboriginal craftsman temporarily displaced in the USA, has created the beautifully "sand painted" natural elbow boomerangs pictured below. Serious collectors can inquire at:

The Boomerang Factory
5014/18 Oakwood Road, NW
Huntsville, Al. 35896

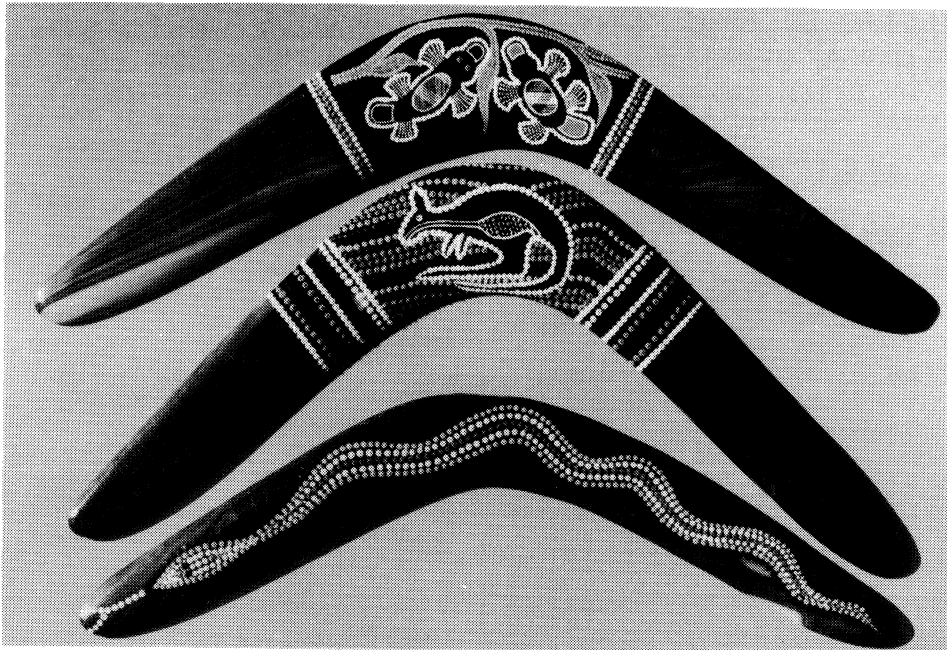

Aboriginal Art by Greg Nolan

Jonas Romblad
Annebergsvagen 32
136 66 Handen
Sweden

Jonas Romblad will be touring the USA this summer (probably in August). He would like to meet throwers in the USA. If you have some time to throw with Jonas, please drop him a line with an invitation. The friendships developed by such offers are usually well worth the effort expended.

DAN
RUSSELL

P.O. Box 84895
San Diego, Ca. 92138

Write and inquire about Dan's source of 5mm 10-ply Finish Birch and Cyalume capsules.



BOOMERANG MAN

1806 North 3rd RM
 MONROE, LOUISIANA 71201

(318) 325-8157

Hours: 10 A.M.-12 Noon & 2 P.M.-5 P.M. (Central Time)

FREE CATALOG!

Always something new and exciting!

MOOMBA!!!!

"Giving fast, personal service always."

Rich, The B-Man

"Your satisfaction guaranteed."

Copyright

BLUE STAR

RANGS

Competition Boomerangs
 from the birthplace of the
Challenger III

- * LONG DISTANCE
- * FAST CATCH
- * 40-METER HEAVY WIND
- * HARDWOOD LAMINATES

Send SAE to:

VOLKER BEHRENS
AM Muhlenberg 11
2407 Bad Schwartau
West Germany

BOOMERANG BALL

by Roger Perry

On Saturday, the 25th of February, boomerang throwers and friends travelled from throughout Perth to attend Western Australia's (and possibly Australia's) first boomerang ball. Over 200 people made the trip to Karragullen, situated in the picturesque hills area; a half hour drive from the city.

After setting up the tents on the oval and organizing the hall in readiness for the night to come, we took the opportunity to introduce people to the kangaroos. Karragullen Oval is situated in the middle of bush country. At around 7:00 PM, as many as 50 kangaroos came out to feed and watch the boomerang throwers.

With the onset of darkness, it was time to feed the large group of people. And in true Aussie tradition, four large barbecues turned out 150 steaks, 200 sausages, 300 fillets of fish, and enough

salad to feed an army.

At 8:30 PM, A to Z, a leading band from Perth got the crowd up and dancing with non-stop Raggae music till the wee hours of the morning.

At 2 AM, we all decided to get the night sticks out and have a bit of a throw. Even the prescnce of a little rain didn't deter people from throwing and partying on until after 4:00 AM.

By 6:00 AM, a couple of keen throwers decided it was time to start the days proceedings with an early morning throw before breakfast.

Most of the revellers weren't looking nearly as well as they did the night before as they wandered around aimlessly until the 10:00 AM coaching clinic began. Conditions were a little tricky with some patchy rain and gusty winds, but everyone managed to get their booms to return and have a great time. The day finished off at noon with a demonstration of large Aboriginal boomerangs.

Another boomerang ball will be held next year. Anyone interested in going can contact Roger Perry at the address below.

Roger is the editor of a new Australian boomerang publication called the Karragullen West. Austr. (KWA) Bulletin. The KWA Bulletin will be published 3 times a year. Write to Roger for more information.

Roger Perry
15 Thomas St.
East Cannington
Perth 6107
W. Austr.

MORE FAIRY TALES COME TRUE

Matthieu Weber, from Geneva, Switzerland, has become the latest addition to the Super Catch Honor Roll. An 18 year old Swiss competitor, he took first place in the Paris tournament's Australian Round event. Look for this name in future tournaments to rack up points for the Swiss Team.

SUPER CATCH HONOR ROLL

Ted Bailey
Rob Croll
Eric Darnell
Doug DuFresne
John Flynn
Torsten Fredrich
Mike Forrester
Michael Girvin
Rob Greer
Thomas Hartmann
Dennis Joyce
John Koehler
Uli Konzelmann
Ray Laurent
Gerrit Lemkau
Barnaby Ruhe
Chet Snouffer
Olivier Vouktchevitch
Matthieu Weber



TEAM GEL'S 1989 IBA BOOMERANG CHAMPIOSHIPS

by Michael "Gel" Girvin
Photos by Jeff Schwartz



In December 1988, Pay Rose (Santa Cruz State College, California), Randy Free (University of Oregon, Eugene), Jake Disston (Reed College, Portland, Oregon), Paul Kimball (Evergreen State College, Olympia, Washington) and Michael Girvin (Art Institute, Chicago, Illinois) formed the Intercollegiate Boomerang Association (IBA). They decided that there were just too many colleges with Team Gel Boomerang Clubs not to have an Intercollegiate Championship. The IBA then compiled rules and events that were taken from USBA, International, and Team Gel rules.

The IBA Philosophy:

The facade called competition is an excuse to get together with other boomers and have a good experience where time seems to stop because you are there., in the present, catching your boom with friends. Any competition with rules and regulations that, supposedly, can determine who the *best* is, has the premise that there is a *best*. But there is no *best*. If a *best* is determined, that decision is purely subjective. As an example: one set of rules can say that whomever catches the most juggles is the *best*, but at the exact same moment, another set of rules can say that whomever puts out the most effort trying to juggle is the *best*. Both set of rules are totally subjective. As a result of the world's wonderful subjectiveness, all of the IBA rules can change if

the context demands. Fun and enjoyment are the determining contexts.

The rules were written up as a starting point. The twelve team events that the IBA defined are: *Team Catch*, *Team Supercatch*, *Team Aussie Round*, *Team Accuracy*, *Team Endurance*, *Round Rang Relay*, *Team Juggling*, *MTA Race*, *Fast Catch Race*, *Team George*, *Team Whoa Nelly*, and *Team Style Outback*.

There were so many highlights during the three day event that only a few can be told here.

On Friday, April 7, 1989 the sun came out for the first time in 29 days over the Evergreen State College in Olympia, Washington. It had been raining over the previous 29 days. Six colleges with with Team Gel boom clubs from around the USA converged on the Evergreen boomerang fields on Friday afternoon - everyone there had 65 new friends. Smiles and happiness buzzed in circles in the blue sky. Over in one corner of the field about 20 people spontaneously created a new game. All of a sudden, everyone playing the game turned toward a different group of boomers, among them was Per Bernstein, and said: "Per Bernstein, say a word!". Per responded: "Cauliflower!". The new game had a name They continued playing *Cauliflower*. One to three boomers would throw, and while their booms were in the air, someone would scream out a catch. "One-handed behind the knees!", "Stand up foot catch!", "Diving head catch!". Dinner was eaten at the organic-type-hippie restaurant next to the field at the Community Center. All of the out-of-town boomers were put up by the in-town-boomers.

Saturday morning, April 8, when all the boomers awoke from their dreams of radness, breakfast was made and had. The boomerang field was still green and wet and the sky was still blue. Thirteen women and 52 men made up 13 teams. An opening ceremony, introducing all the collegiate IBA Team Gellers started off the day with a full return when Pay Rose threw out the first boom, and with a flip next to the incoming boom, caught it one handed clean. Matilda Bay got it all on video. The gentleman behind the video camera said: "If you guys are going to have fun, then we're going to have fun too." And they did have fun taping the event filled day that saw Doug DuFresne doing an outstanding job as the contextual head judge and Ali Fujino as the helpful and exuberant score keeper. The bleachers and hills surrounding the field filled with spectators. The highlight of Saturday's events was *Fast Catch Race*. There has never been a better spectator event than this. Never. Each team sent one person into the event. Each one of those persons picked a number from the hat - that number determined who they were to race. The winners of the first round of races picked numbers again. The winners of the second round went on to the final round.

Bruce Blake (Chicago), Michael Girvin (Chicago) and Casey Larrance (Evergreen) step to their markers. First one to catch five wins. "Go!" screams Doug. Casey, Michael, and Bruce throw. The booms fly and turn. Bruce catches, and throws. Michael and Casey catch. The crowd screams with smiles as the race rages. Michael and Casey throw, dead even. Bruce catches his second and



Michael "Gel" Girvin & Paul Kimball Orchestrate

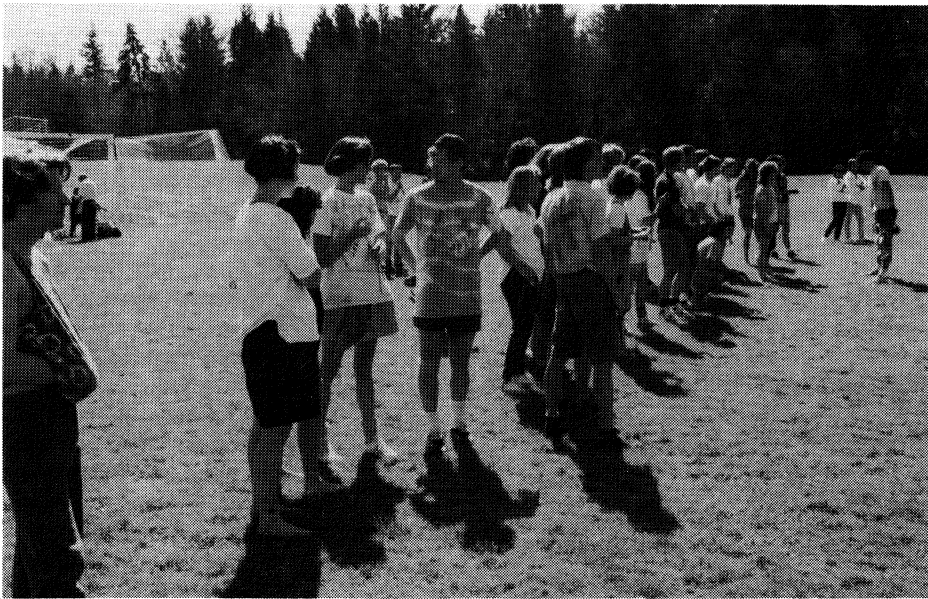

Lining up for George

throws his third. Michael and Casey catch and rip their third round off. Bruce holds his hands out to catch his third throw. The crowd is on their feet. Bruce slaps his hands together without a catch. Michael and Casey catch. Michael throws an easy one to help battle the wind. Casey throws only a bit harder than Michael. Bruce runs and retrieves and throws his third. Casey and Michael are head to head. The crowd is on their toes. Michael catches his fourth throw an instant before Casey catches number four. Casey and Michael throw, milliseconds separating them. Bruce catches number three. Michael's and Casey's booms in the air create anticipation in the crowd. Eyes widen. Casey's boom goes high, Michael's low. They both stand on their markers, with hands waiting. The booms descend. A catch by Michael. A second elapses. A catch by Casey. The crowd goes wild.

Saturday night started with a party in the meadow down by Puget Sound, and then moved to the Boomerang Dance in the Community Center.

Sunday, April 9, saw the sun, blueness, spectators and happiness that were present the previous two days. The highlight of all the events contested on Sunday was *Team Style Outback*. There are no rules, only context. One team goes out and does whatever, and the other throwers assign points to them. Team Gel UofO built a human pyramid and threw and caught. Team Funky Boycott threw down their booms, turned on the

tape deck and danced. Team Gel-O assigned points to the crowd for it's radness. Team Gel-Reed threw naked and made X-rated catches that gave them 18 million points for a first place win. After Sunday's events, there was a huge hotdog barbecue with kegs in front of the Community Center. The award ceremony was about to begin.

Seventy handcrafted boomerangs laid on the sun warmed cement in front of the Community Center. Standing around the prize booms were 13 handsome sculptures, and above them were 195 hand drawn and printed awards stacked on the table. The 65 friends and 100 spectator/friends stood around the art work. Silence fell over the campus. Something incredible had happened and was about to happen. The award/trophy person read the first award and broke the silence. ex-

uberant happiness manifested itself as screams and yells. All awards were given out. All boomerangs were given out. And then Team Gel Broccoli (Evergreen), Team Gel Reed (Reed College), Team Gel-O (Art Institute), Team Gel Overhug (Evergreen), Team Gel UofO (Eugene), Team Gel Funky Boycott (Evergreen), Team Gel Squishy Slug (Evergreen), Team Gel Stirs (Evergreen), Team Gel-E (Art Institute and University of Chicago), Team Gel S.C. (Santa Cruz), Team Gel Frolic (Evergreen), Team Gel Pickup (Evergreen), and Team Gel Rock (Evergreen) respectively picked up their sculptures that were their trophies. Team Broccoli picked a trophy from among the 13 and handed it to the trophy person. While the trophy person wrote "First overall IBA Championships" on the trophy, Paul Kimball said: " You know who won? Team Gel won!"

There are no words that can describe the smiles that everyone felt.

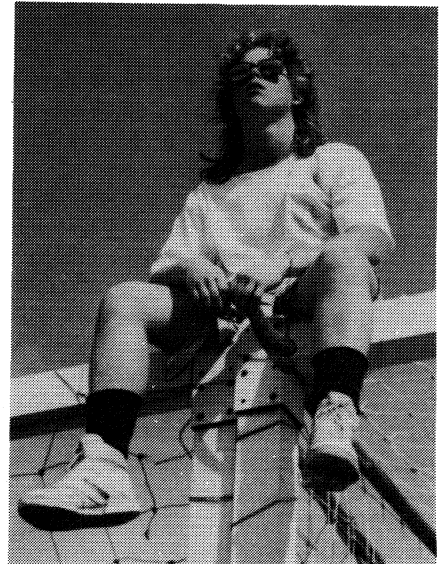

Steve Kavanaugh gets Rad

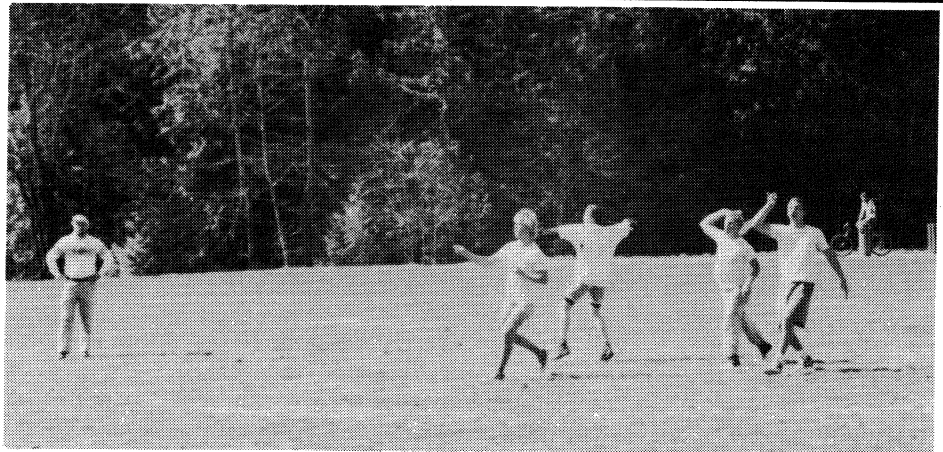

Team Gel Santa Cruz does Whoa Nelley

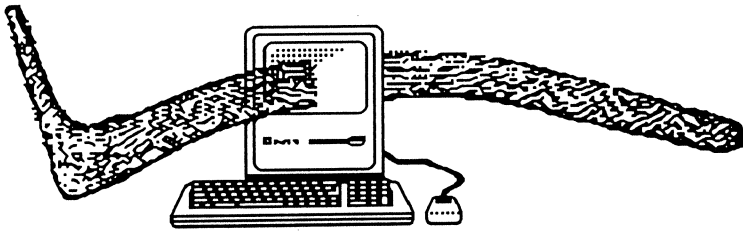

BOOMERANGS & COMPUTERS

The *Boomerangs & Computers* column that has appeared in recent issues of MHR has stimulated quite an interest. This Spring, the editor received more correspondence on this topic than all other topics combined. Therefore, the *Boomerangs & Computers* column in this issue is dedicated to informing the readers who is active in computer programming and what programs are available to the readers.

John Jordan of the British Boomerang Society modified the *Gerhard Bertling Flight Simulator Program* to run on his Acorn Archimedes (RISC) with BBC Basic V. John sent in a beautiful sample program output which included a large isometric view and a small bird's eye view for reference. John wants to incorporate the effects of wind direction; the effects of spin on lift and drag; add an animated thrower; add animated boomerang spin/translation; and extend operation to the mouse.

Jim Martellotti, of Tustin, Ca., has modified the *Gerhard Bertling Flight Simulator Program* to run on the IBM PC and produce a four view output. This includes a bird's eye view, two orthogonal side views, and an isometric view. He also has a program available where the user inputs a viewing angle and a large isometric view with the corresponding angle is output. Both of the flight simulator programs are available in both a Basic and a compiled version to the readers on a 5 1/4 inch IBM PC floppy disk at a nominal charge of only \$5 (domestic) or \$8 (overseas). The compiled version does not require the Basic software to run, and it executes about 10 times faster than the uncompiled version. Program modifications cannot be made to a compiled program. The programs can be ordered directly from Jim Martellotti at the address that follows. The nominal charge is extremely reasonable compared to the time required to key in, translate, and de-bug the flight simulator program previously published in MHR.

John Mauro, of Richmond, Va., has also made modifications to the IBM PC version of the *Gerhard Bertling Flight Simulator Program*. His version of the program is modified to include an annotation of the development history and an explanation of the input variables. Two versions of John's program are available: in monochrome, and in color. Both of these versions are available in basic and compiled into an executable file, requiring only a DOS system to run. Interested readers can purchase the John Mauro programs at a nominal copy charge of \$5 (domestic) or \$8 (overseas) from the address that follows. Please specify 5 1/4" or 3 1/2" disk format.

Tom Tuckerman, of Berea, Oh., is a computer specialist by profession. He also has translated the flight simulator program for operation on the IBM PC. Tom compiled the USBA rating system and data management files and is available to answer questions that readers may have on translating files between different systems. He can be contacted at the address that follows.

Richard (Dick) Kutscher, of St. Paul, Mn., has translated the *Gerhard Bertling Flight Simulator Program* to operate on the Apple Macintosh. He has also translated all the other programs which were published in subsequent issues of MHR. The programs contain comment cards for ease of use. All programs, except one, dump the output to the screen. The remaining program dumps the output to the printer. Dick has requested that the editor supply copies of these programs to

any of the readers who may have interest. Therefore, Macintosh users with a 3 1/2 inch 400K or 800K disk drive (please specify format) may order a copy of all five programs directly from Ted Bailey at a nominal charge of \$5 (domestic) or \$8 (overseas).

Dean A.R. Kelly, of Salem, Or., is a professional computer programmer experienced with writing complex systems using dBASE III & dBASE IV. Dean has written a compiled mailing list and report generator called dBOOM (version 1.2). The program is a powerful and flexible database for keeping track of people. Each entry can be categorized with up to 5 different codes making the program ideal for managing your boomerang contacts and customers. This makes it simple to keep track of several different mailing lists all on one system. Creation of labels and reports can be based on entries from all the fields. Dean is interested in writing a universal program for rating competitors during competition. When the program is fully mature, it will be a valuable tool for easily rating competitors during a tournament.

All of the individuals mentioned in this column have volunteered their services unselfishly so that the readers can enjoy the many benefits of computer technology. The addresses of those who have been mentioned in this column are listed below for the readers to make contact should they desire to do so. Please share your computer experiences with MHR in the future.

Ted Bailey
2967 Gracewood Rd.
Toledo, Oh. 43613

Dean A.R. Kelley
3350 Neef Ave. SE
Salem, Or. 97302

Richard H. Kutscher
1349 So. Prior Ave.
St. Paul, Mn. 55116-2656

Jim Martellotti
13401 Del Cerro Dr.
Tustin, Ca. 92680

John B. Mauro
11434 Westcreek Ct.
Richmond, Va. 23236

Tom Tuckerman
55 Barrett Road #333
Berea, Oh. 44017

John Jordan
9 Bowood Drive
Wolverhampton WV6 9AW
United Kingdom

BOOMERANGS FROM JAPAN

Manfred Stahle of the Swiss Boomerang Federation was fortunate enough to get a business trip to Japan and meet up with Yoshinobu Sakimitsu and members of the Japanese Boomerang Association pictured on the right at their first throw in 1989. Manfred took several photographs of the diversified and innovative boomerangs that the Japanese throwers have developed. It has been said that working boomerangs have been made in the shape of all 26 letters. Now that statement can be extended to the thousands of Japanese alphabet characters. Yoshi wrote MHR to identify the manufacturer of the complex planform boomerangs as Kiichi Muraoka who will make a boomerang out of any shape using 3mm plywood. A uniquely shaped boomerang, called "Kanji" and standing for the common family name: "Forest" was mailed to the editor as a gift. The boomerang flew like a butterfly with just an easy toss. The Japanese Boomerang Association, which publishes an excellent newsletter in the Japanese language, is planning on participating in the 1989 International Team Cup in June and hopes to sponsor the 1990 International Team Cup in Japan.



POLAR BOOMERANGS

Dr. Bob Reid is a lucky man. He has a job that takes him to exotic locations. A recent trip took him to the South Pole so that he could take measurements of the Cosmic Rays. Arriving at the South Pole on 19 November 1988, he had to adjust to air at -39°C and an elevation of 9300 feet above sea level. The ice is 9000 feet thick at this location and the sign which marks the location of the geographic pole moves about 10 metres a year because of ice drift. The photograph at the upper right shows Dr. Bob Reid throwing one of Gordon Shuttleworth's "Orbit Halo" omega boomerangs around the pole. A 20" Backwood, a homemade CND model boomerang by Dr Reid, and the Shuttleworth omega boomerang are depicted in the lower photo showing three boomerangs adorning the Geographic South Pole marker. Three boomerangers will be wintering over at the sight insuring that boomerangs will continue to circumnavigate the pole all year long. Hopefully we will hear more on these exploits of these British throwers in the future.



Bob Reid Throws an "Orbit Halo" Round the South Pole

BOOMERANG RESEARCH PAPER IS AVAILABLE

Deborah Reynolds of Cahokia, Il. and Michelle Siess of Labadie, Mo. are senior Aerospace Engineering students at Parks College located in Illinois across the river from St. Louis. They have completed a 23 page research paper: "Boomerangs: What Goes Around, Comes Around". The paper was presented at the AIAA Conference in Minneapolis, Mn. last April. The research which focuses on the forces generated by the boomerang airfoil at different orientations will pave the way for future studies on the dynamics of why a boomerang returns. It may possibly be incorporated into the computer analyses presented in earlier editions of this newsletter. Anyone interested in obtaining a copy of the informative technical paper (the price is \$20 postage paid) can order one directly from the authors at the address below.

Deborah Reynolds
Box 1078
Parks College
Cahokia, Il. 62006
(618)-337-7989

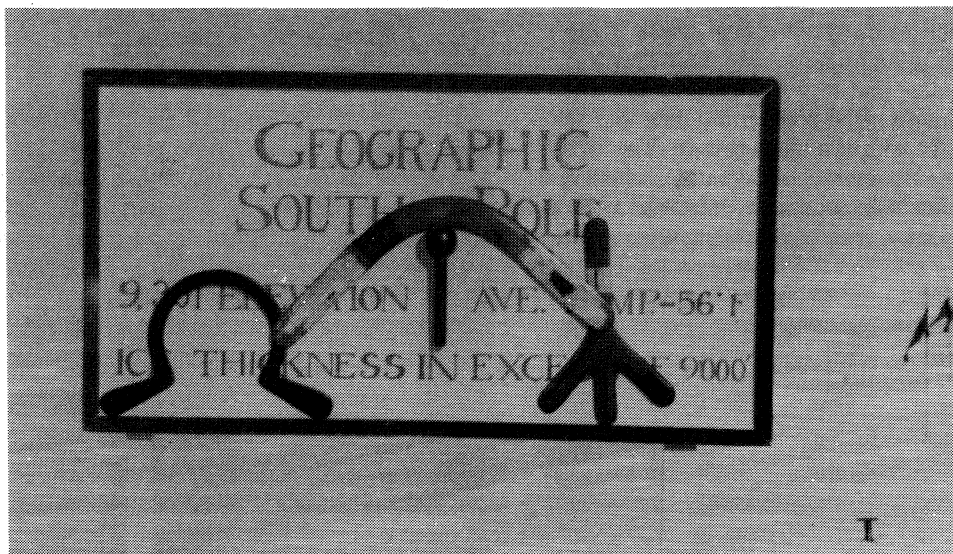

The South Pole Adorned With British Boomerangs

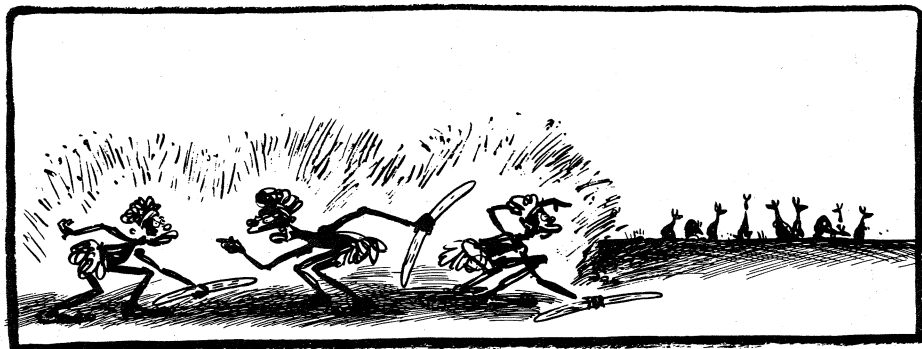

... et si tu veux manger quelquechose au déjeuner, arrête de crier HEADS !

- and if you want to eat something for lunch, stop shouting "HEADS"!
another cartoon by Olivier Voukchevitch

USBA INFORMATION PAGE

Many Happy Returns

Circulation: 600 Worldwide.
Published by the:

U. S. Boomerang Association
P.O. Box 182
Delaware, Ohio 43015

Editor/Art Director:
Ted Bailey

Publishing Director:
Jim Jordan

Advertising Director:
John Flynn

Mechanical Measurements:
Image area: 9.5" deep by 7.5"
wide; 3 columns to a page; width
of a column: 2.25".

Advertising Rates:

| | |
|-----------------|-------|
| Full Page | \$200 |
| 2 Columns | \$150 |
| 1/2 Page | \$115 |
| 1 Column | \$80 |
| Per Column inch | \$10 |

10% discount for four consecutive issues. Camera-ready copy preferred. Composition billed at \$10 per hour. Publisher reserves the right to refuse any advertisement or cancel a contract without reason. Mail all advertisements to:

John Flynn
RR #2 Box 209-8
White River Jct., Vt. 05001

The deadline for advertising is approximately March 1 for the Spring issue; June 1 for the Summer issue; September 1 for the Fall issue; and December 1 for the Winter issue. Early ads with payment will receive the best placement.

SPECIAL NOTICE

The new 1989 USBA Rules & Rating System Booklet is available through the USBA address below. Members in the USA and Canada may order copies for \$2 each; add 50 cents postage per order. Overseas members can order the booklet for \$5 airmail postage paid.

U. S. Boomerang Association
P.O. Box 182
Delaware, Ohio 43015

NEWSLETTER SUBMITTALS

All submissions to this newsletter should be mailed to the editor:

Ted Bailey
2967 Gracewood Rd.
Toledo, Ohio 43613

The deadline for submissions is the same as for advertising; or whenever that issue fills up. Get you articles in early. Material should include print quality art or photos. The editor reserves the right to edit all materials.

USBA VIDEO ARCHIVES

Collecting . . Editing . . Sales

Garry Lamothe
18 St. James Ave.
Easthampton, Ma. 01027

Write for a price listing of selected titles including: historical tournament reviews, scenes from both domestic & overseas shows, scientific, and ethnographic materials, etc.

USBA information and listings are available from the USBA headquarters staffed by Chet Snouffer. For more information, contact:

USBA
P.O. Box 182
Delaware, Oh. 43015

MEMBERSHIP INFORMATION

All membership dues should be paid directly to the membership chairman by check or money order in U.S.A. dollars. Domestic and Canadian dues are \$10 per year or \$150 for life. Overseas dues are \$20 per year or \$250 for life. Check your newsletter expiration number which is printed on the mailing label.

USBA MEMBERSHIP
C/O Tom Tuckerman
55 Barrett Road #333
Berea, Ohio 44017

USBA BOARD OF DIRECTORS

President

Dennis Joyce
44 Lucinda Ct.
Hampton, Va. 23666

Vice-President

Chet Snouffer
51 Troy Road
Delaware, Ohio 43015

Treasurer

John Flynn
R.R. #2 Box 209-8
White River Junction, Vt. 05001

Secretary

Tom Tuckerman
55 Barrett Road #333
Berea, Ohio 44017

Directors

John Derden
9 Cole Grove Drive
Swainsboro, Ga. 30401

Jim Jordan
11813 Silent Valley Rd.
Gaithersburg, Md. 20878

John Koehler
17121 Spates Hill Rd.
Pooleville, Md 20837

Garry Lamothe
18 St. James Ave.
Easthampton, Ma. 01027

BetsyLew Miale
8019 234th S.W. #214
Edmonds, Wa. 98020

PRINTED MATTER



**USBA MEMBERSHIP
55 BARRETT ROAD #333
BEREA, OH 44017
U.S.A.**

ISSUE: 41
Dale W. Riendeau
PO Box 484
Jackson, CA 95642

**USBA TOURNAMENT HOTLINE:
(619)-298-4283**

**Please note that your last issue of the USBA
newsletter is printed on your mailing label.**

