

Many Happy Returns

No. 41

\$2.50

An International Publication of the United States Boomerang Association

Winter 1990

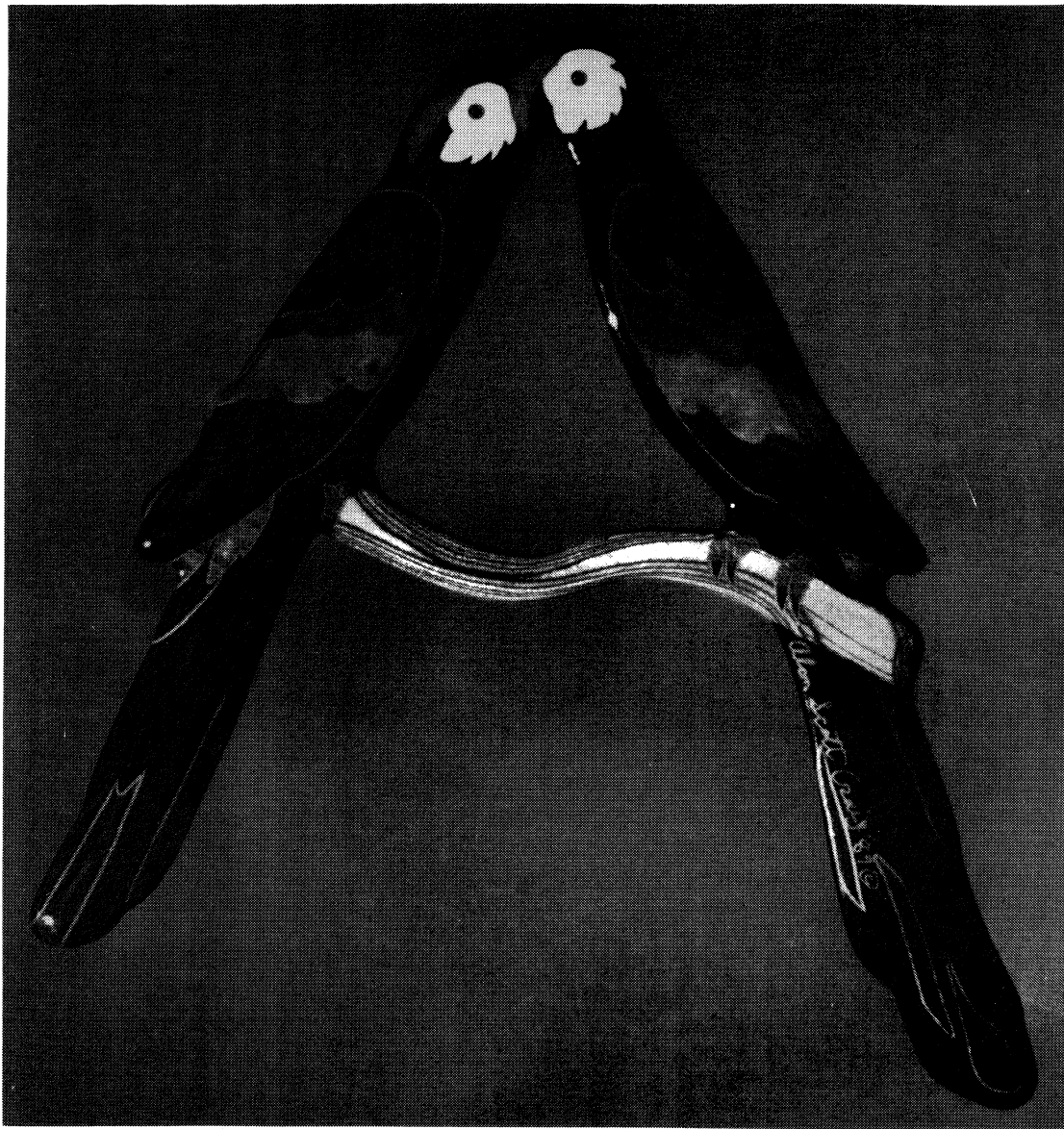

THE "DOUBLE PARROTS" BOOMERANG by ALAN SCOTT CRAIG

Winter 1990

Many Happy Returns

1



WHAT'S HAPPENING IN THIS ISSUE?

New Boom Clubs	2
News from France & Sweden	2
News from Poland	2
News from Canada & Australia	3
1989 German Nationals	3
1989 European Championships	4
Roger's U.S. Trip No. 2	5
Sorting Out a Solution	6
1989 USBA Nationals	6
1989 Free Throwers Tournament	8
First Annual Thuba Tournament	8
Summer's Final Fling	8
Boomerangs in Lit., Music, TV	9
Boomerang Team-Texas	9
New Products	10
Boomerangs in China	12
Boomerangs of Egypt	13
Promoting USBA Membership	13
More Fairy Tales Come True	14
Booms in Uruguay	14
Breakin World Record Barriers	15
Advertisements	17
Boom Auction	18
1990 USBA Nationals	18

CONGRATULATIONS !!!

Congratulations are in order to **Barnaby Ruhe** who received his PhD in Shamanism and Modern Painting last summer after years of study (in between boomerang tournaments). Barnaby, who was Oliver North's classmate at the Naval Academy, also holds a B.S. degree in Engineering.

NEW BOOM CLUBS

Olivier Vouktchevitch writes to tell us of clubs from Spain and Italy that participated in the 1989 European Championships in Evry, France. We offer them our best wishes with hopes that Spain and Italy become major players in the European boomerang theater of the 1990s. The addresses of the prime contacts follow:

Mario Crescimbeni
Boomerang Club Verona
 17, Via Scarsellini
 37100 Verona
 Italy

Fernando Linares
Club Di Portivo Fortuna
 Apartado 856
 20080 San Sebastian
 Spain

Gunter Wandtke, a member of the German team in the 1988 World Cup in Barooga is well, and living in the country of New Zealand. He has gathered a group of native throwers who meet regularly on the beach. Their favorite event is MTA. If anyone is traveling to New Zealand or simply wishes to make contact with this group, you can write to Gunter at:

Gunter Wandtke
 23 Barrington St.
 Hohepa Homes
 Christchurch 2
 New Zealand

NEWS FROM FRANCE

Jacques Thomas of La Perouse Boomerang Club announces that the "2nd Intercontinental Games of Prehistoric Weapons" will be held in Belgium in October 1990. For more information on the involvement of boomerangs in this affair write to:

Jacques Thomas
 24, rue Tronchet
 69006 Lyon
 France

NEWS FROM SWEDEN

Many of the U.S. throwers remember last summer's charming visitor from Sweden: Jonas Romblad. He writes the following greetings to all the friends he met on his tour.

I will not be able to repeat my summer 1989 trip in 1990 because of active military service, but maybe in 1991? My trip this past summer was simply marvelous and I was constantly surprised by the hospitality everywhere. I learned a lot about boomerangs and met lots of nice people. The trip also gave me an idea of how useful the boomerang was to the Aborigines. I have for instance used an MTA to eat yogurt on the bus. Of course, any boomeranger who drops by Sweden is invited to stop by for a visit. He can be reached at the following address:

Jonas Romblad
Annebergsvagen 32
 136 66 Handen
 Sweden

NEWS FROM POLAND

Janusz Jacek is interested in bringing the first boomerang team from an Iron Curtain country to the next European competition. The only problem is that he requires sponsorship. The East Germans had a physical barrier (like the infamous Berlin Wall). The Poles are contained by a more effective barrier called economics. The average monthly Polish salary wouldn't buy you a meal in a good U.S. restaurant. How would you like to work a week to buy a Boomerang Fever? If anyone in the European theater can provide sponsorship for a small group of Polish throwers in the upcoming season, Janusz would like to hear from you. He can be reached at the following address:

Janusz Jacek
FABRYKA MASZYN
 38-100 Strzyzow
 ul. 1 Maja
 Poland

NEWS FROM CANADA

James Bradley has resurrected the Canadian Boomerang Association and seeks contact with other Canadian throwers, as well as from clubs of other regions.

Jim has a goal of producing a top quality video presentation on the sport of boomerangs. He desperately needs pictures or video of anything associated with boomerangs, especially Australian Aboriginal, Egyptian, & Hopi Indian throw sticks. Other requirements include pictures of T-shirts, team pictures, museum exhibits, books and anything else appropriate. Here's your chance to receive credit for your contribution into a first rate boomerang promotional tape. Jim would like to finish the tape by March of 1990.

Jim plans on writing a book or producing a semi-annual newsletter in the near future. You can contact him at the address below:

Canadian Boomerang Assoc.
James Bradley
P.O. Box 9331
Stoney Creek, Ontario
Canada L8G-4S1

NEWS FROM AUSTRALIA

Lorin Hawes writes to tell us that he has sold his boomerang factory on Hope Island and plans to pursue his favorite occupation - Sailing. He is busy finishing off the end of his stockpile and plans on passing his business on to his daughter and son-in-law who have recently returned from missionary duty in Zambia. He plans on a visit to the American Southwest sometime in 1990. Collectors should take note to obtain examples of his works as they will most certainly be collector's items in the near future. Rumor has it that the B'Man has the remaining supply of Lorin's boomerangs. Write to the address in the B'Man's ad; illustrated on page 17 of this issue.

1989 German Nationals

by *Gerhard Bertling*

After a week of rainy and stormy weather, the sky turned blue. It was Saturday, 5 August. By coincidence, it turned rainy again the following Monday. The guy who makes the weather must be a boomerang enthusiast!

We started at 11:00 AM with Fast Catch. The wind blew with 4 Beaufort! Thus, no records were set. Forty-six year old Hartmut Steeb had luck with a dead calm and won Fast Catch with 28.49 sec. Thomas Patzer was second with 29.77 sec. and Uli Konzelmann was third with 30.41 sec.

The second event was Endurance. The wind blew undiminished. It was Torsten Fredrich who won with 41 catches. Wouter Wessels from the Netherlands and Uli Konzelmann tied for second with 39 catches.

Because of the strong wind, MTA₁₀₀ was cancelled.

On Sunday morning we started with Australian Round. There wasn't a cloud in the sky and the wind was still blowing strong. Hans-Georg Schnauffer won Aussie Round with 62 points. Patrick Plagge had 61 points and Stefan Bohm had 59 points.

The overall winner was Hartmut Steeb. Runner-ups were Ulrich Roos(2),

Torsten Fredrich(3), Klaus Zacher(4) and Uli Konzelmann(5).

It was not a competition for records, but it may have been the biggest boomerang event ever. There were 120 throwers and 12,000 spectators! All local newspapers and TV stations were present! Besides the competition, Frisbee demonstrations (Wall City Frisbee Club, World-record-holder in Frisbee-delay: Peter Jibs from Denmark, Frisbee freestyle, etc.), Kite performances, and the European champion in Hacky-Sack amused the spectators.

There was also a boomerang exhibition and a boomerang workshop where everyone had the opportunity to make and throw boomerangs.

On Sunday night, a group of throwers from the Netherlands and Germany threw across the East German Wall (see the Summer 1989 cover of MHR) and around a large building called "Siegessaule" (=victory column). Foreign throwers were: Ola Wahlberg from Sweden, 7 throwers from the Netherlands (Max Hoeben, Fedde Engwerda, Wouter Wessels and the beautiful Lalita Tournay), and Manfred Stahle from Switzerland.



1989 European Championships Evry, France

by *Olivier Vouktchevitch*

It was the first European Individual Championships held on 9 & 10 Septembre. Everything was fine: good weather, calm wind, and a lot of fun.

The overall winner was Fridolin Frost, 17 years old, a student of Volker Behrens and better than his master now! Sunday was his day with first place wins in Accuracy, Endurance and MTA. Fridolin broke the world record in MTA₁₀₀ with the incredible time of 1 minute, 24.67 seconds. Fridolin caught his MTA with one foot on the line and the other one in the air outside the circle. *Udo Wennig of West Germany was the previous record holder with a time of 1 minute, 1.07 seconds set just two weeks before in a Geneva tournament. Udo's MTA drifted only a total of 20 metres.*

Eric Darnell was present as a specially invited guest. He did well in Fast Catch, Consecutive Catch and Distance. After bombing out in Aussie Round, he still placed fourth overall. Matthieu Weber of Switzerland was another contender for excellent placing until misfortune struck with no catches in MTA. Still he ranked seventh overall.

Uli Konzelmann, one of the serious challengers, was very, very unlucky: an automobile accident on the way to the tournament and then a burglary in his rental car in which some of his best boomerangs were stolen! This was probably the reason he did not place in top ten as expected.

Italy and Spain were represented on the field and did well for their very first time in competition.

The young throwers did a great job: Oliver Von Kempfen of West Germany is sixth overall and only 16 years old. Michael de Ceuninck of Belgium is only 15 years old and he took the accuracy event. And of course Fridolin, the winner is only 17 years old!

Germany has allowed the use of tri-bladers in competition while other countries have not. Thus we took a vote before the tournament and the results were to allow only two bladed boomerangs.

Promotion of the event by television was very successful. A total of five big channels were on the field, as well as many magazines.

Jacques Rondaut was selected as the head judge and did an excellent job. Charles Delaunay and Helene Mathonnet ran the computerized ranking system which included a portable laser printer on the field with output within 10 minutes of the completion of each event. A summary of the results follows in the next column:

MTA₁₀₀

1. Fridolin Frost	West Germany	84.67 sec.
2. Robert Emmert	West Germany	51.47 sec.
3. O. Vouktchevitch	France	48.60 sec.
4. Thomas Munch	West Germany	38.43 sec.

Endurance

1. Fridolin Frost	West Germany	49 catches
2. Uli Konzelmann	West Germany	49 catches
3. T. Stehrenberger	Switzerland	48 catches
4. Matthieu Weber	Switzerland	44 catches

Fast Catch

1. Robert Emmert	West Germany	25.68 sec.
2. Matthieu Weber	Switzerland	26.15 sec.
3. Eric Darnell	USA	28.74 sec.
4. Volker Behrens	West Germany	29.30 sec.

Consecutive Catch

1. Matthieu Weber	Switzerland	10 catches
2. O. Vouktchevitch	France	9 catches
3. Eric Darnell	USA	8 catches
3. Volker Behrens	West Germany	8 catches
3. T. Stehrenberger	Switzerland	8 catches
3. Gregory Bisiaux	France	8 catches

Aussie Round

1. Artur Ruckert	West Germany	62 points
2. Volker Behrens	West Germany	58 points
3. Manfred Stahle	Switzerland	58 points
4. O. Vouktchevitch	France	57 points

Accuracy

1. M. De Ceuninck	Belgium	36 points
1. Fridolin Frost	West Germany	36 points
3. T. Stehrenberger	Switzerland	35 points
3. Kim Galeazzi	Switzerland	35 points
5. O. Vouktchevitch	France	34 points

Long Distance

1. Volker Behrens	West Germany	117 metres
2. Eric Darnell	USA	96 metres
3. Robert Emmert	West Germany	89 metres

Overall Placing

1. Fridolin Frost	West Germany	291.0 points
2. O. Vouktchevitch	France	275.5 points
3. Volker Behrens	West Germany	256.0 points
4. Eric Darnell	USA	241.5 points
5. Axel Heckner	West Germany	235.5 points
6. Thomas Munch	West Germany	233.0 points
7. Matthieu Weber	Switzerland	232.5 points
8. T. Stehrenberger	Switzerland	230.5 points
9. Kim Galeazzi	Switzerland	228.0 points
10. Robert Emmert	West Germany	225.5 points

ROGER'S U.S. TRIP No. 2

by Roger Perry

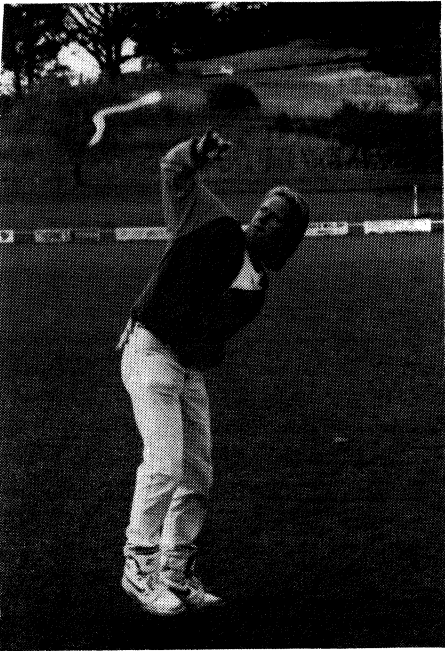

My trip started with some last minute boomerang making with Rob Croll in Melbourne.

From Melbourne, Rob and myself flew to Sydney; then from Sydney to L.A.; then L.A. to Denver. The flight from Denver to St. Louis (our last leg) was delayed indefinitely due to storms, so we took time out to teach the stewardesses the fine art of indoor boom throwing on a plane. We finally arrived in St. Louis 36 hours after leaving Melbourne. We were greeted at the St. Louis airport by Tom Fitzgerald and Ted Bailey. After spending a couple of nights with Tom, Ted drove us to Toledo for some rest & recuperation. We stayed with Ted for a week. During that time, we made a sojourn to Canada. We booked into a motel room in the tiny town of Warton on the Bruce Peninsula and realized there were only 2 beds for three people. A heated argument ensued over who had to share a bed. The dispute was resolved with a mini boomerang competition. Rob won and ended up with the single bed.

After Toledo, Ted drove us to Pennsylvania for a brief stay with Al Gerhards. It was certainly a thrill to throw with Al and for the first time in my life, I managed to do Super Catch.

From Al's, we drove to Gaithersburg for the International Team Cup. The Australian team was hosted by Barnaby

& Edward Ruhe with Edward feeding us too well. The cup was an exciting time. On my previous visit, I missed meeting many of the top US throwers; and for the first time I was given the opportunity to meet and throw with competitors from around the world.

After saying good-bye to the rest of the Australian Team, and the other throwers, Moleman, Rob Parkins, Michael Siems, Robby and myself drove to Barnaby's farm in Pennsylvania for a day and night and from there I was dropped off in New York.

In New York, I stayed with Shelley Mack for 10 days and managed to get in more trouble than Crocodile Dundee. After escaping from New York with my life still intact, I flew down to Virginia to stay with Dennis Joyce.

Dennis had organized a beach house in North Carolina with some friends. We all had a great time there, learning the southern accent, throwing booms, eating vegimite sandwiches, and celebrating the Fourth of July.

From there I flew to Washington, D.C. to spend a few days with Ron Tamblyn and other throwers from that area.

After Washington, D.C., I flew to St. Louis to stay with Tom Fitzgerald & Peter Robson. A demonstration was given at the St. Louis Science Center fair.

After St. Louis, I bused up to Kankakee for the weekend to boom with throwers in the Mid-West. Rich Westerman was the host there.

Bryan Myers then took me to stay with him in Chicago. There were many highlights for this part of the trip including throwing and catching a boomerang on the main street while the others watched the traffic to insure that I wouldn't be hit. From Bryan's, I stayed with Maria Nelson, a top thrower who also lives in the city. We saw some top Blues and Reggae bands there.

From Chicago, another bus trip took me to Ft. Wayne for a supposed rest and recuperation, plus some badly needed boom practice for the Delaware & Cleveland Comps.

Unfortunately, Sean & Willie plus Thuba friends had other ideas and we spent a considerable time checking out the Ft. Wayne fun spots. With the international Thuba road trip team in readiness, we drove to Delaware, then Cleveland for the Comps.

From Cleveland, I flew to San Francisco for three days before flying out to

Denver for the USBA Nationals. In Denver, I rented a car and drove to Gunnison where I stayed with Jim Mayfield for a week before the comps.

Colorado is a beautiful area surrounded by mountains. Some of the highlights were going to the Hot Springs, catching up with Michael Girvin, and pulling a fun stunt on Dennis Joyce at the Denver Airport.

The Nationals were very competitive even if all the top throwers were not able to attend. At the end of the comps, Dennis Joyce, Jonas Romblad, and myself drove to Denver for the trip home.

I spent a day with Bob Kley before flying off to Australia.

My trip lasted 2 1/2 months and was entirely enjoyable.

I would like to thank all the people who hosted me during my stay, and the memories from friends made will certainly last forever. In conclusion, I hope that any throwers or friends in the states can someday make it to Australia's top city: Perth so that I may return the hospitality.

MORE ON ROGER PERRY

Roger dazzled U.S. boomerang throwers this past summer with his special art boomerangs. He has decided to make these T-shirts available in the U.S.A. Tom Fitzgerald of the St. Louis Boomerang Club will carry Roger's T-shirts. They are attractively priced at \$18 + \$3.50 P&H. You can write Tom and inquire as to availability at the following address:

**Tom Fitzgerald
1159 Holly River
Florissant, Mo. 63031**

Roger is also the editor of the "West Australia Boomerang News", a publication of the **Karragullen Boomerang Club of Western Australia**. Members of the club are entitled to receive the publication, a T-shirt, a badge, and discount prices on other Australian and Boomerang paraphernalia. Membership outside Australia can be obtained by sending (Aust.) \$25 + \$5 initiation fee to the club president at the following address:

**Clint Liddelow
C/- P.O. Box 223
Armadale, W.A. 6112
Australia**

SORTING OUT A SOLUTION

by Roger Perry

Having thrown for over 5 years, and in that time having met many throwers from all over the world, I realize that all have varied opinions on rules; i.e. what constitutes a legal boomerang; whether 3 bladed (or more) booms should be allowed in competition; and so forth.

Some people like to throw big boomerangs and let them land. Others like the competitive events. One thing that all countries have in common is that they like to throw returning boomerangs. Rules governing events are starting to come together and most countries seem to like the current USBA rules.

To further sort our competition rules and boomerang shapes, I have a two party plan. First, a nominated representative from each country should be able to sit down and sort out any existing problems regarding rules. They could then report back to their organizations. This could be achieved sometime within the next 6-12 months. As far as rules regarding legality of boomerang shape, size, number of arms, etc., I think there is an easy answer. Australia and some other countries are opposed to three bladed boomerangs. My solution is to allow 3, 4, or whatever bladed boomerangs as long as it constitutes returning principles in the International and World Cup competitions.

But, this does this mean that the country holding the International or World Cup would be obliged to abide by the International rules.

This result would serve many purposes. First, we would be seen as an internationally unified body so that in the future, Olympic Competition would be a possibility. Another bonus is that throwers at all levels and manufacturers would know exactly what to expect in all future World and International Competitions.

I think that the sooner that a representative from each country gets together, the better. Negotiations would not be too difficult; and let's face it: we all want to see boomeranging go in the right direction.

I would like to hear any ideas from other throwers who may read this!

Roger Perry
155 Fremantle Road
Gosnells
Perth 6110
West Australia
Australia

1989 USBA NATIONALS

Chet Snouffer of Delaware, Ohio was overall champion at the 1989 USBA Nationals, held August 18, 19, 20 in Gunnison, Colorado. Jim Mayfield, maker of those nice Colorado boomerangs, was tournament director and host extraordinaire, and though the remoteness of the site prevented many from attending, about 40 novices and veterans signed up to play. Throwers came from all over the country, some making the weekend part of a longer vacation to the area, and some flying or driving in just for the tournament. At 7700 feet altitude, Gunnison is close to Crested Butte Ski Area and sports like mountain biking, climbing, and skiing are popular. There's even windsurfing at a nearby man-made lake; so boomeranging fit in well as another fun outdoor activity.

Leading up to the tournament, a lot of thought was given to the effects of thin air on the 'rangs. Would the old trusty favorites still work? How much range in Fast Catch and Aussie Round? Will MTAs hover? Or will they sink like stones? As it turned out, most 'rangs had about 15% more range, but 'rangs with unusually low flight patterns were often unable to return completely, forcing alternate choices to be made quickly.

Things got started Friday night with an indoor tournament where throwers used styrofoam 4-bladers for some of the usual USBA events like Juggling and Fast Catch. Everybody was happy to be in Colorado and hoping for good weather for the weekend.

Day 1 started at 9:30 AM under clear, calm skies with Fast Catch. John Flynn used an 18 metre 'rang that expanded to 22 metres at altitude to take the event with 23.22 seconds for 5 catches, just beating Chet Snouffer (23.93) and Gregg Snouffer (24.12). Then the wind arrived just as Fast Catch ended. Wind with a capital W. So much for good scores; well, almost. The next event, Count-up, featured the Snouffer brothers defying the conditions to tie for first with 10 catches each. No one else topped 8 catches. In Doubling, Chet and Flynn tied for first with 7 catches in 12 attempts. In Accura-

cy, Chet again worked the wind to score 30 points, beating Flynn (28) and Pay Rose (24). Chet thus succeeded in taking the Accuracy prize that eluded him last year in Pa. when an 8 point throw accidentally hit his foot.

A break followed, ending with a relay demonstration for the spectators. By being right on Highway 50, the main drag in town, many people were able to check out the tournament, buy 'rangs, hang out, and enjoy the crisp Rocky Mountain day.

Endurance was the final event of day 1. Ah . . . Endurance. Mother Nature chose this event to remind everyone exactly where the Nationals were taking place. The triple-whammy combination of high altitude, blinding sun, and gusting 15-25 mph winds made the 5 minute catching event a grueling exhibit of why boomerang throwers are looked at as sometimes being a bit off-center. How tough was it? It was so tough . . . that Eric Darnell had 9 catches in the first minute and finished with 11. . . that Chet Snouffer had 15 catches . . . that Barnaby Ruhe had 7 catches . . . that Michael Girvin had 16 catches. Actually, there was a winner. Australian Roger Perry, wrapping up his visit in the U.S., caught his first 14 throws and finished with 21. Ron Tamblyn, Gregg Snouffer and Pay Rose scratched and clawed their way to 20 catches for a second place tie. With the first day of throwing completed, Chet Snouffer held a 0.5 point lead over John Flynn and 14 points over Pay Rose in third.

The evening began with a Colorado style Ribs & Chicken Bar-B-Q and a talk about natural elbow boomerangs by Eric Darnell. The USBA Auction followed with Barnaby and Gregg running the show, and once again it succeeded at raising funds for USBA. The high point had to be when a Roger Perry competition T-shirt sold for forty-count'em-forty dollars, a new record for a non-Gel T-shirt! Other items auctioned included a B-rang license plate and a Bat-a-Rang. After the auction, a stirring conceptual lecture on the philosophy of RAD by Michael Girvin, a boomerang poem by Pay Rose, and the fourth annual Team Gel Fashion Show closed out the evenings official activities.

For Day 2, the competition was moved to Gunnison High School for the big field events: Juggling, MTA₁₀₀, and Australian Round. The day began with light winds and overcast skies, perfect for Juggling, it would seem. In fact, Michael Girvin and Jim Jordan had 31 and 17 juggles on the board as Chet Snouffer took his turn on the field. Chet immediately found a groove using 8 second flights and 3 second delays before throwing. This gave him 5 seconds to track and catch each 'rang, and when he finally dropped one, 89 successive catches had been completed! A new Competition World Record, surpassing Bob Burwell's elusive record of 69 set at the 1982 Nationals in Fairfax, Virginia. It was a special treat for throwers and spectators to watch Chet put it together and take out a record that many throwers felt they could break, but couldn't.

After Juggling, the bright mountain sun came out, the winds increased, and it was time for MTA₁₀₀. In practice, it became clear that the thin air was not a limiting factor, so everyone used their best sticks. Willie Davis from Team Thuba took first with an impressive 42.91 seconds of hang time. Dennis Joyce was second with 42.16 and Chet took third with a wind aided 35.53. The boomerang drifted 15 feet outside the 100 metre circle at 25 feet altitude, then mysteriously changed direction and floated back to Chet, who caught the 'rang clearly just inside the line and looked around knowing that he'd gotten the break he needed to take the overall title. John Flynn placed ninth in MTA, so heading into the final event: Australian Round, Chet held a 10.5 point lead. The only possibility for losing would be if Flynn won Aussie Round and Chet did not place in the top 10.

During the break prior to Aussie Round, the USBA held it's Annual Meeting and voted in the following officers: President - Betsylew Miale; V.P. - Chet Snouffer; Treasurer - John Flynn; Secretary - Gregg Snouffer; Directors - John Derden, Jim Jordan, Dean Kelly, John Koehler & Garry Lamothe. Dennis Joyce assumes the position of President ex-officio.

Also during the break, the wind

picked up considerably, similar to the previous day, so the last event shaped up to be a real challenge as throwers had to deal with gusty winds and unpredictable swirls coming off the school building. Chet scored a solid 30 in the tough conditions, and Doug DuFresne had a top score of 48 when John took his turn. Flynn's throws were shredded by the winds and his score of 18 meant Chet was overall champion for the third consecutive year. With the outcome decided, the last several throwers took their best shots at the high altitude winds. Roger Perry, in the final throwing group, showed everyone how to handle the conditions and fittingly won the event with 63 hard earned points. Doug took second and Michael Gel was third with 46.

Afterwards, everyone enjoyed a delicious Mexican dinner and the prizes were awarded by Jim Mayfield, who received a standing "O" for organizing such a fun weekend, on his first try! Jim credited the DuFresnes, the Jordans, Dennis and Gregg as being Mega-helpers running the show, and it was true. Socializing and night throwing lasted well into the night as people made the most of what was left of the weekend.

The next day, everyone went their own ways, but no one who was there will forget what it's like to throw boomerangs in the Rockies.

OVERALL PLACINGS

1.	Chet Snouffer	67.50 pts
2.	John Flynn	52.50 pts
3.	Michael Girvin	41.50 pts
4.	Roger Perry	33.25 pts
5.	Gregg Snouffer	31.50 pts
6.	Peter "Pay" Rose	30.50 pts
7.	Doug DuFresne	26.75 pts
8.	Ron Tamblyn	25.00 pts
9.	Jim Jordan	19.75 pts
10.	Micho Gravis	19.25 pts

FAST CATCH

1.	John Flynn	23.22 sec
2.	Chet Snouffer	23.92 sec
3.	Gregg Snouffer	24.12 sec
4.	Doug DuFresne	24.23 sec
5.	Eric Darnell	25.18 sec

CONSECUTIVE CATCH

1.	Chet Snouffer	10 catch
1.	Gregg Snouffer	10 catch
3.	Roger Perry	8 catch
3.	John Flynn	8 catch
5.	Michael Girvin	7 catch
5.	Doug DuFresne	7 catch
5.	Jim Jordan	7 catch

DOUBLING

1.	Chet Snouffer	7 catch
1.	John Flynn	7 catch
3.	Peter "Pay" Rose	6 catch
3.	Michael Girvin	6 catch
5.	Micho Gravis	4 catch
5.	Ron Tamblyn	4 catch

ACCURACY

1.	Chet Snouffer	30 pts
2.	John Flynn	28 pts
3.	Peter "Pay" Rose	24 pts
4.	Gary Knudsen	20 pts
5.	Micho Gravis	16 pts

ENDURANCE

1.	Roger Perry	21 catch
2.	Ron Tamblyn	20 catch
2.	Peter "Pay" Rose	20 catch
2.	Gregg Snouffer	20 catch

JUGGLING

1.	Chet Snouffer	89 catch
2.	Michael Girvin	31 catch
3.	Jim Jordan	17 catch
4.	John Flynn	10 catch
5.	Jerry Caplan	8 catch

MTA₁₀₀

1.	Willie Davis	42.91 sec
2.	Dennis Joyce	42.16 sec
3.	Chet Snouffer	35.53 sec
4.	Michael Girvin	34.88 sec
5.	Jerry Caplan	34.09 sec

AUSTRALIAN ROUND

1.	Roger Perry	63 pts
2.	Doug DuFresne	48 pts
3.	Michael Girvin	46 pts
4.	Ron Tamblyn	44 pts
5.	Micho Gravis	38 pts

1989 Free Throwers Tournament Summary

The 1989 Free Throwers tournament was held on August 5 in tricky throwing conditions. As usual, Chet Snouffer walked away with first place honors.

Jacques Sabrie placed first in Consecutive Catch with 10 out of 12 catches. Sean Marquardt, Matthieu Weber, Chet & Gregg Snouffer, and Will Gix all tied for second with 7 catches.

Rick Szumski took first place in the Accuracy event with 29 points. Matthieu Weber was second with 26 points and Bryan Myers was third with 25 points.

Matthieu Weber dominated Fast Catch with a time of 30.05 seconds in difficult conditions. Chet came in second with 35.10 seconds.

Chet's only first place finish was in Aussie Round with 66 points. Chuck Smith & Willie Davis were right behind with 65 and 64 points respectively.

Reverend Jim Schramm took MTA₁₀₀ with 36 seconds even. Jacques Sabrie was close behind with 33.89 seconds and Chicago Bob, using the same MTA as Reverend Jim came in third with 33.13 seconds.

Roger Perry and Will Gix tied for first in Doubling with 10 catches. Chet Snouffer was third with 8 catches.

Overall placings were:

- 1 - Chet Snouffer
- 2 - Matthieu Weber
- 3 - Will Gix
- 4 - Gregg Snouffer

FIRST ANNUAL THUBA TOURNAMENT - 1989

The First Annual Thuba Tournament was held in Ft. Wayne on June 25. The scores reflected the excellent throwing conditions.

Torsten Frederick dominated Consecutive Catch with a perfect 12 out of 12 catches. Matthieu Weber was right behind with 11 catches and Fridolin Frost & Gregg Snouffer both caught 10.

Chet Snouffer took first place in Accuracy with 39 points. Matthieu Weber had 35 points and Torsten Frederick had 32 points.

Mark Legg cracked the 20 second barrier for a first place in Fast Catch with 19.88 seconds. Chet played it safe with a second place time of 24.44 and Fridolin Frost followed at 25.17 seconds.

Chet was back in the first place slot for Aussie Round with 78 points. Matthieu Weber and Chuck Smith followed with 69 and 68 points respectively.

Chicago Bob set the pace in MTA₁₀₀ with a time of 49.01 seconds. Using the same boomerang, Reverend Jim trailed with 40.71 seconds. Sean Marquardt was third with 35.18 seconds.

It was Chet again with 12 catches in Doubling for first place. His brother Gregg was right behind with 11 points. Torsten and Matthieu tied for third with 9 catches.

Gregg Snouffer was hot in Endurance with the top score of 60 catches. Chet and Matthieu were right behind with 58 and 56 points respectively.

Torsten Frederick took Juggling with 11 catches. Sean Marquardt, Mark Legg & Matthieu Weber tied for third with 8 catches. The overall winners were:

- 1 - Chet Snouffer
- 2 - Torsten Frederick
- 3 - Matthieu Weber
- 4 - Gregg Snouffer

Summer's Final Fling

by Doug DuFresne

The Septembre 17, 1989 Summer's Final Fling took place in Portland, Oregon on a day during which rain was forecast. Competitors voted as required in the alternate schedule submitted earlier in the week to the USBA President. Of the 19 throwers present, 17 elected to run the full schedule of events as published in the flyer - - in spite of the fact that there was heavy rain within a couple of miles of the tournament site when the throwers arrived. We were lucky. It did not rain at all during the tournament. Thanx to the fact that there were only 19 veterans and 10 novices, the last event started on time and the awards party took place in daylight. It was held indoors because of rain.

Winds varied throughout the day starting light and very shifty, and ending strong and shifty. The worst winds prevailed during the Australian Round and Juggling events. A summary of the results follows:

Doug DuFresne started off in excellent shape taking first place positions in Count-up Consecutive Catch (10 catches) and Accuracy (44 points). Doug matched his score in Accuracy with that in Australian Round (44 points) taking first in that event as well. Doug tied for first in Doubling (6 catches) with Steve Kavanaugh and tied for second in Juggling (1 catch) with almost everyone else. Steve Kavanaugh did well by placing in the top 5 of every event except Accuracy. Tim Schalberger took a first in Juggling with 2 catches. Tim also took a first in Fast Catch (30.21 sec) and Endurance (32 catches). Dean Kelly took a first overall in MTA₁₀₀ with a time of 34.06 sec. Jake Disston placed in top 10 in everything except MTA₁₀₀. Dennis Joyce, Betsylew Miale, Will Gix, Peter Pay Rose, T.W. Smith & Gary Knudsen all did well, finishing in the top 10 overall. The overall winners were:

- 1 - Doug DuFresne
- 2 - Tim Schalberger
- 3 - Steve Kavanaugh
- 4 - Jake Disston

BOOMERANGS IN LITERATURE, MUSIC, AND ON TV

Ted Bailey rented several shows from the series: **The Outer Limits**; and found one of the greatest boomerang videos ever in the episode titled "Fun and Games". The 52 minute show features approximately 20 minutes of scenes in which an alien chases two earthlings around in a primeval forest throwing a wicked metal boomerang, with serrated blades, at them. In the end, the alien drops the boomerang on the bank of a river to do battle with the earthman only to have the earthwoman pick it up, throw it at him, and do him in. This one is well worth renting and viewing.

Ben Ruhe sent in an article from the Octobre 18, 1989 issue of the **Washington Post** titled "Tricks and Treats" featuring a boomerang promotional by Barnaby and Ben Ruhe for Qantas Airlines. The article had a neat picture of Barnaby doing the William Tell stunt with a cross stick boomerang.

Michael Hanson of the BBS is temporarily residing in the USA near Buffalo, N.Y. This has not stopped him from promoting the sport as he recently wrote a comprehensive article on boomerang science for the September 1989 issue of **Physical Education** (a British publication) and titled: "The Flight of the Boomerang".

Mary Coughtrie found the **Widget Factory Card** pictured below in a card shop. The card, designed by Suzy Becker, depicts a flock of boomerangs heading south for the winter.



An article appeared in the June 11 issue of the Texan publication: **Brazosport Facts**, covering the promotional activities of Bob Rudy and Dave Hughes. Bob and Dave gave two excellent demonstrations at the Brazosport College on

June 15. They also had a collection of over 150 boomerangs from their combined collections on display. The librarian was amazed at the enthusiastic response the public gave at the show. They are currently in the process of forming a boomerang organization in the Texas area. We desperately need a southern coast club. Good luck to them.

Olivier Voukchevitch produced a gorgeous full size poster for the European Championships in Evry, France last fall. The figure below illustrates the basic theme of the poster that will become a collector's item in the future.

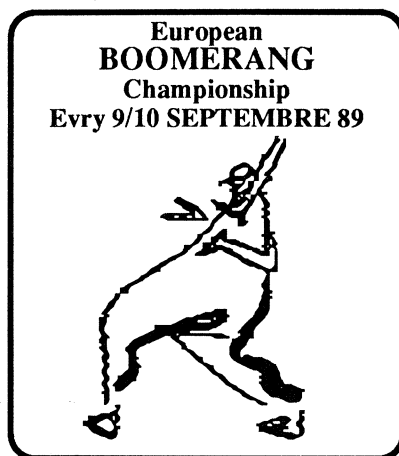

Richard Harrison, the Boomerang Man, sent in a copy of the April 14, 1989 issue of the **News-Leader**, a Springfield, Missouri newspaper which featured an article written by Edward Kenney and titled "Defy gravity, time zones: Try a boomerang". The article featured such feats as Jay Perrett's throw around the South Pole, Gerhard Bertling's throw over the Berlin Wall, and other special feats performed by boomerang enthusiasts.

H.L.Mayhew sent in an excellent article from the July 21, 1989 edition of the **Daily Hampshire Gazette** featuring Jim Youngblood of Amherst and his distance record throw at the International Team Cup in June. Proper credit was given to Ray Laurent and Volker Behrens who significantly influenced Jim's record.

Another cartoon with boomerangs has surfaced. This time it is the ever popular **DUCK TALES**. In one segment, the ducks were on a mission in Australia. The bad guys used remote control metal boomerangs as weapons. The good guys (or is it ducks?) used wooden boomerangs launched with a stretched inner tube. The simulation was excellent!!!

1990 World Distance Comps

Denis Lemaitre, president of La Perouse Boomerang Club de France has announced a World Distance Championship to be held at Le Bourget Airport on June 23rd & 24th, 1990. The competition will be part of a flight festival with backing from the Air & Space Museum. Selection from each country will be based on previous performance in the distance event. If you are interested in attending, please write to Denis at the following address:

La Perouse Boomerang Club
6, rue des Etats-Generaux
78000 Versailles
France

HELP!

One of the first books totally dedicated to the sport of boomerang throwing was a small Puffin publication titled "**The Boomerang Book**" by Michael Hanson. This 48 page booklet was charmingly illustrated by Robin Lawrie. It so happens that the author, Michael Hanson, doesn't have a copy for his archival system and desperately needs one. If any of the readers have a copy they would be willing to let go, please send it to Michael at:

Michael Hanson
292 East Main St.
Springville, NY 14141

BOOMERANG TEAM - TEXAS

Bob Rudy and Dave Hughes are in the process of forming a quality boomerang club for the state of Texas. Future plans include a newsletter and get-togethers. Write or call either Bob or Dave at the addresses listed below:

Dave Hughes
1414 Airline North
Rosharon, Tx 77583
(713)-431-2015

Bob Rudy
Rt. 2, Box 219J
West Columbia, Tx 77486
(409)-345-3584

NEW PRODUCTS

Richard Harrison, the Boomerang Man, informs us that he is now carrying a special line of **Gel Boomerangs** made by none other than Michael "Gel" Girvin himself. High performance, attractively decorated, strong (5 - 12 ply), and at ridiculously low prices (all under \$20), these sticks are priced to sell. Richard raves about the **Synchronicity Boomerangs** with exceptional art and flying characteristics. The B'Man has a limited supply of real Aboriginal boomerangs, crafted in the USA by Greg Nolan, who has since returned to his native land. These are real scarce items. Some are natural elbows. Some are beautifully decorated. Collectors would be wise to get them while they can. B'Man has some new Colorado Boomerang T-shirts with a sharp redesign. And for the connoisseur of oddity sticks, Richard is now carrying Tumble-sticks at a low, low price. For those of you who do not know what these are, they are one bladed boomerang which require a totally unique style of throw. Are they legal in competition? Who knows? But they sure are lots of fun. B'Man has a special where you receive 4 tumble sticks, 2 Gyro Stars and holographic foil tape for only \$10 (+\$3 domestic shipping).

B'Man will supply the new plastic Aerobie Orbiter triangle boom pictured to the right at \$13 for one, \$22 for two, or \$26 for three; shipping included for domestic customers. See page 11 for more info on this product.

And how about those non-boomerang things? B'Man has the Tornado tube. The plastic double nut joins two plastic soft drink bottles. When the pair is half filled with water and inverted like an hour glass, the draining water forms a well defined miniature tornado. You can buy one or several dozen at a low wholesale cost and market them to your friends. Other new non-boomerang things include quality throwing knives to keep your arm in shape over the winter and genuine Aussie Bull Roarers made out of Black Wattle wood. The Bull Roarers are premium items at the low price of \$15/one or \$22/two; domestic shipping included. Haven't received a B'Man catalog for at least six months? Drop him a line requesting one and you'll receive a \$2 credit on your next order! See the B'Man ad on page 15.

Volker Behrens is a hot supplier of

competition boomerangs. Volker is the one and only source for the **Carbon Fibre Challenger III** which Jim Youngblood used to set a world record in distance at 136 metres this past summer. Another product line is **Paxolin MTAs** for medium and high winds. He has already lost one to the jet stream god when it disappeared from sight after only 2 1/2 minutes. Another competition product that Volker offers for competition is the **Paxolin-Windeater**. This is a Vee-shape that works well in anything from a little to a lot of wind. This boomerang placed 1 & 3 in the World Opens and 1 & 2 in the European Championships this summer. You can write Volker for information about purchasing his products at:

**Volker Behrens
Beuthiner Hof 4
2420 Eutin
West Germany**

Gregg Snouffer is one of America's best competitors and his equipment is part

of the reason for his success. Gregg now offers a special line of competition quality boomerangs so readers who are not so adept at making specialized 'rangs can do well in competition too. All his models are durable, brightly painted and attractively priced at \$20 (and under) each. Here is a great source for MTA, Fast Catch, Consecutive Catch, Doubling, and Juggling boomerangs. Gregg is also a partner in a new boomerang manufacturing business with another premier boomeranger from Delaware, Ohio - Rick Tilford. The company is called **Round-trip Boomerangs** and produces an array of models for beginner to advanced throwers. These boomerangs are available to wholesale outlets at ridiculously low prices. It almost doesn't pay to make booms any more with these guys offering such good stuff and at such a low price. The company also has a line of styrene plastic tri-bladers. These are flat and stiff with a dimple pressed into the tips to induce convex curvature to the upper surface. The tri-bladers (illustrated on following page) are incredibly stable in flight and come in two sizes. These are ideal for short range demonstrations and

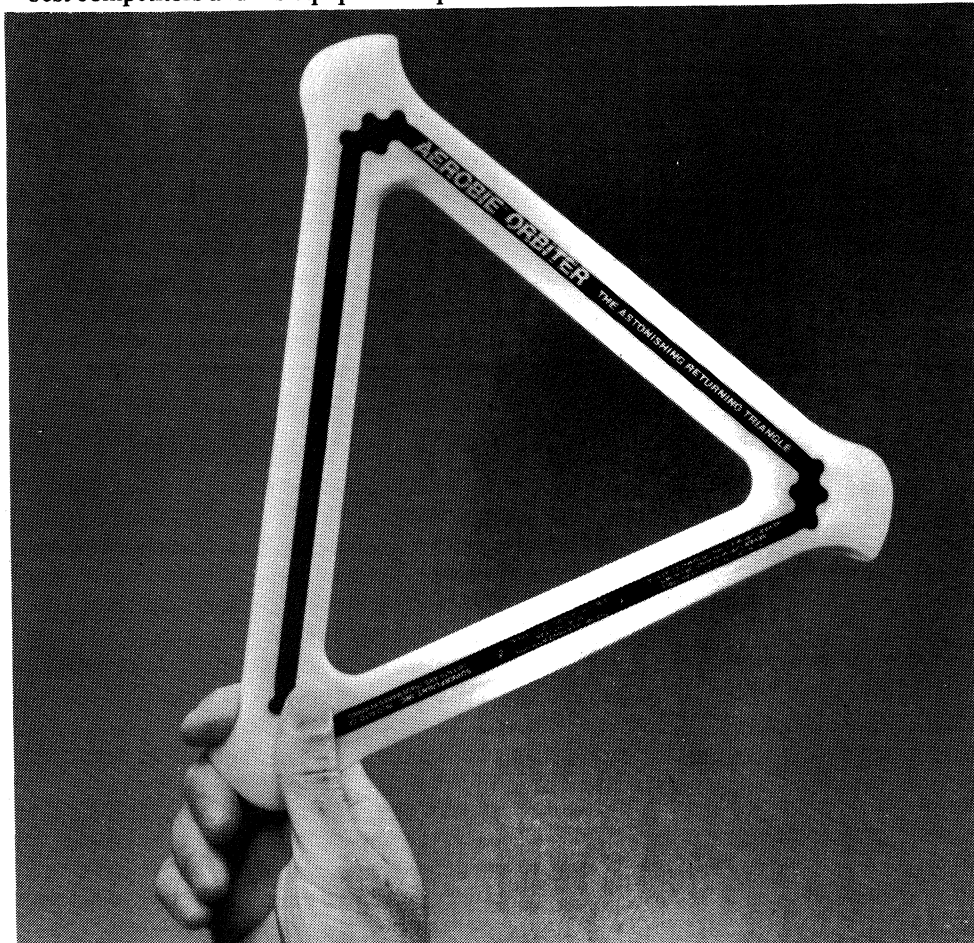

The New Aerobie Orbiter Creation by Alan Adler

for usage by young children such as in scouting groups or at birthday parties. In wholesale quantities, the small model is \$.49 each. Write to Gregg and Rick for more information on their products at:

ROUNDRIP BOOMERANGS
340 Troy Road
Delaware, Oh. 43015
 or call
(614)-363-4414

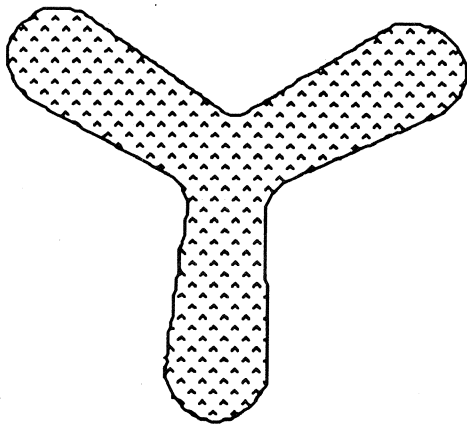

Roundtrip Tri-blader

Chet Snuffer has informed us of a great place to buy quality boomerang wood, but only if you make a lot of boomerangs, like he does. **Plywood & Door** carries 4, 5 & 6 mm aircraft plywood in 4'x4' or 5'x5' sheets. They ship by truck and require a minimum order of ten sheets. If interested, you may request a price listing by writing to the address below:

PLYWOOD & DOOR
7701 W. 79th St.
Bridgeview, Il. 60455
(312)-594-5530

Alan Adler, creator of a long line of flying toys (Aerobie, Skyro, Whamo Tri-Blader, etc.) has come up with another winner: a Triangle Boomerang called the **Aerobie Orbiter**. Although this is not the first triangle boomerang ever produced, it employs many new innovative design features such as flexible legs for tuning, swept-back tips, and a downward curl on the trailing edge of the each tip to induce washout. The Aerobie Orbiter, pictured on previous page, is an incredibly stable boomerang and is quite safe because of it's light weight and soft edges. It works best in light winds and has a

range of 25 - 30 metres.

This is a must-have boomerang for the collector of unique shapes. The price of the Aerobie Orbiter is expected to be the same as that of the Aerobie. The boomerang production line began in November and will be sold through most outlets that carry the Aerobie. Individuals interested in wholesale quantities of the Aerobie Orbiter or Aerobie can write to Alan Adler, in care of his company, at the address below:

Superflight, Inc.
81 Encina Ave.
Palo Alto, Ca. 94301
(415)-321-5050

Eric Darnell has announced that he will carry a new line of French made plastic boomerangs that come in a variety of shapes and in both day-glo yellow polypropylene and black carbon fibre reinforced polypropylene. One of the models is especially made for Leftys. Each boomerang bears a logo with **LMI & FOX** as well as the name of the boomerang design originator. The editor sampled four of the prototypes, illustrated to the right, and found them very easy to throw; as well as competition quality. Only the tri-blader had a range of just under 20 metres. The range of the rest varied from 20 metres to 35 metres. The upper and lower figures are models by Christian Jabet. The second from the top is a lefty, designed by Matthieu Weber. And the third from the top is a Carbon-fibre reinforced model designed by Atelier Foulon. The Carbon-fibre reinforced model weighs just 2 ounces. The others are about 1 1/2 ounces each. The tip-to-tip spans are only 10 to 12 inches. Eric has lots of other goodies that boomerang throwers of any age and throwing skill can enjoy: competition wind, adjustable angle, minis, natural elbows, and lots more too. You can write for a price listing of his varied products to the address listed below.

Eric Darnell
Star Route
South Strafford, Vt. 05070

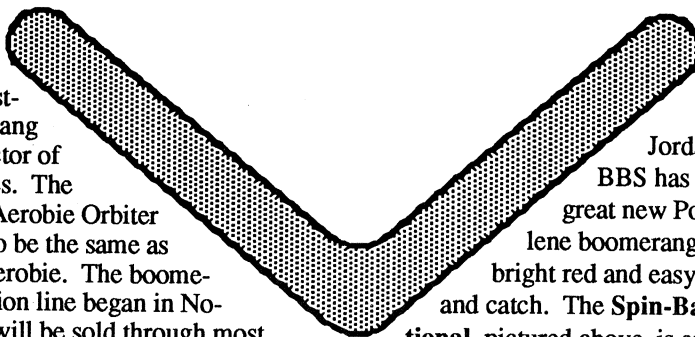

John Jordan of the BBS has released a great new Polypropylene boomerang. It is bright red and easy to throw and catch. The **Spin-Bak Traditional**, pictured above, is expected to retail at about \$5 per unit. It weighs approximately 2 1/2 ounces and has a tip-to-tip span of about 16 inches. Unless you are in England, it is best to restrict orders to wholesale quantities. John can be contacted at the following address:

John Jordan
9 Bowood Drive
Wolverhampton WV6 9AW
United Kingdom

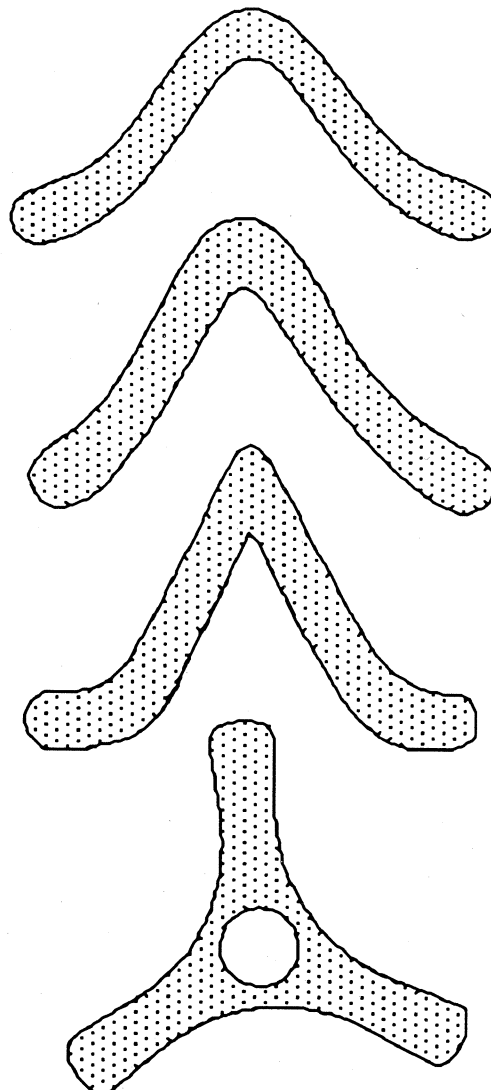

BOOMERANGS IN CHINA

Eric Darnell photographed Yang Xiao Di when he performed in Burlington, Vt. last August. Yang was on tour with the Big Apple Circus this past summer. He had never thrown a boomerang outdoors in his 20 years of professional boomerang throwing until Eric treated him to an outdoor throwing session with contemporary American style booms.

Yang is called the "Monkey King" and is the head of a 20 member troop of acrobats attached to the Big Apple Circus. He lives in a village in China whose citizenry is all acrobats. Here everybody trains for performances in circuses throughout the world. He uses a cross stick for landing on his hands, and a pinwheel to land on his head, which is protected from the sharp pointed tip by a thick felt skull cap. The boomerangs are tuned without dihedral and have positive angle of attack twisted into each tip.

Ming-fong Hwang has provided additional translation of the Chinese text that the Boomerang Man made available to MHR for the Fall issue. The article claims the boomerang was used in China since at least 1300 A.D. The Mongolians used it for hunting, sport, and as a weapon of war. It was popular to use the cross stick in an Accuracy competition! Old literature describes dozens of different throwing routines by many demonstrators during the Sung dynasty. Boomerang construction usually employs cutting out a template from a piece of cardboard to use as a gauge for proper airfoil shaping. Two boards are joined at the elbow to form a cross with four functional blades. The boards are either overlapped and held together with cord or material is removed from each board so that the two boards snap together with all four blades lying in the same plane. The later method provides superior aerodynamics but results in inferior strength due to notch sensitivity. Figures from the Chinese text are illustrated below.

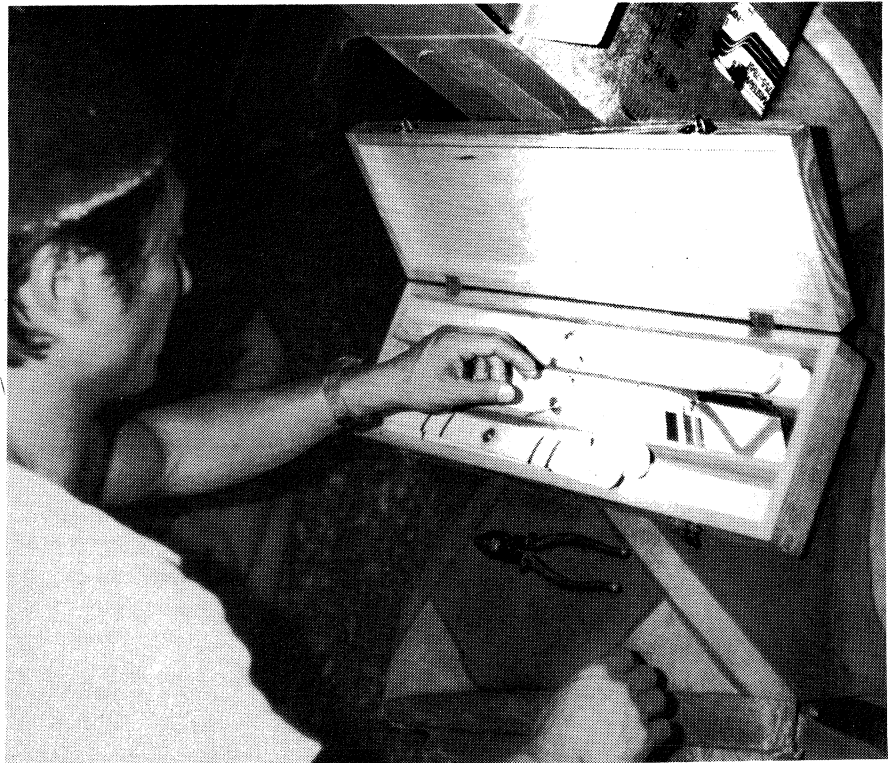
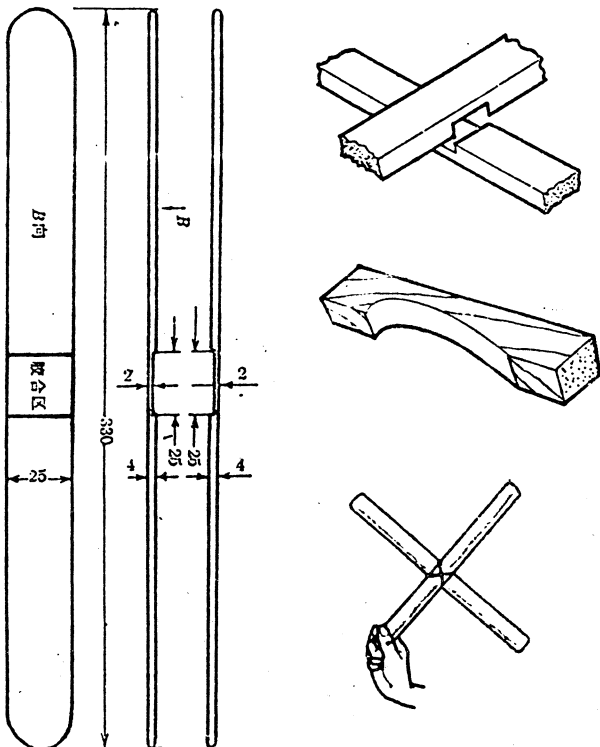

BOOMERANGS OF EGYPT

by Jacques Thomas

The Egyptian Museum in Cairo exhibits the treasure found by Howard Carter in the tomb of the Pharaoh Tut-Ankh-Amen. We may find in this treasure some objects which have the shape and appearance of boomerangs. But what are they really? See "Magic de Boomerang", page 18, by Jacques Thomas for photographic description of these boomerangs.

At my request, the General Director of the Museum invited me to come to Cairo. He had agreed to have the show-cases in which these objects are located, opened and to let me examine them in detail. Thus I was able to collect the exact features of twenty typical pieces in order to make reproductions of them in view of testing their qualities in flight and ability to return.

Those tests allowed me to come to the indisputable conclusion that Egyptians living at the time of Tut-Ankh-Amen (1350 B.C.) knew the boomerang and its return. Most of the facsimiles turned out to be able to fly high and pretty far before returning close to the thrower. With a tight flight path, a fast flight and a strong hitting power, they were certainly used for fowling.

Researchers in the necropolises tombs, some of them inaccessible to the public, having been specifically opened on the occasion, let me find out representations of a given number of objects with the same shape as those found in Tut-Ankh-Amen's tomb. I also met an Egyptian personality who had been witness of fowling parties with boomerangs, years ago.

So, Egypt presents us with 3000 years old authentic boomerangs in a perfect state of preservation. And we might wonder whether the boomerang was known or not in many places all around the world in prehistoric times.

Many subsidiary questions are put to which, following Carter, I tried to bring an answer: exact weight of the objects; original twist of the blades; identity and density of the wood they are made of; useful purposes of partial bark covers; right handed and left handed boomerangs; etc...

Recalling the history of the discovery of these boomerangs in the tomb of the Pharaoh Tut-Ankh-Amen, the keen controversies in the last century regarding the so-called "Egyptian Boomerangs", giving a full account of the method applied and the results obtained, a publication will soon be at the disposal of the public.

PROMOTING USBA MEMBERSHIP

by Dean Kelly

There's been quite a bit of talk lately about promoting USBA membership. Most of that has been on the administrative level and has included such things as requiring that Veterans in USBA sanctioned tournaments be USBA members.

That is all well and good. There are things that can be done at the administrative level to encourage active boomers to join USBA.

But what can we do, as members, to help promote membership?

Well, as it so happens, I have a few ideas (else why would I be writing this article!).

Talking to the media: Many of us have had or will have the opportunity to talk to media people about our sport. I've had newspaper interviews about my booms and about the tournaments that I've put on. Believe me, this is great (and free!) publicity! I always tell them about the USBA. This does two things. The presence of a national organization lends credibility to me and to the sport. Also, it lets people who are interested in boomerangs know that there is an organization there that they can contact to learn more about boomerangs.

Now, whether or not the reporter will use the USBA information is completely out of your hands, but at least you have given the information to him/her.

Instruction Sheets: With each boomerang that I sell, I include a sheet of instructions. On the instruction sheet I include a good plug for the USBA, complete with the USBA address. This gets the word out to the people most likely to become members: the new boomerang owner.

Tournaments: At our tournaments, one of the first things required is announcements. That's order of events, competitor's rights, etc. This is a great time to encourage people to join the USBA. Each

tournament director should take the extra 30 seconds it takes to tell people (particularly novices and spectators) a little about the USBA and what benefits there are to having a membership.

Membership Forms: These should be available at each tournament. While you are Xeroxing all the other forms, etc. that you need, run off a few membership forms and keep them on the scorekeeper's table to be filled out by throwers (who have let their membership lapse or are new members) and to be handed out to interested spectators.

It would even be a good idea to keep a few of these in your boomerang bag to give to the folks who stop to watch you in the park.

Resumes: I always put a plug for the USBA on the resumes I send out after a tournament. This is mainly for novices. They are the people who are most likely to be interested in joining. Now that they've had a taste of our sport, they're going to want more!

Sky Writing: Hire a sky writer to write the address of the USBA above your . . . naw, that is just a bit impractical.

But consider the other ideas. None of these are expensive. Most of them are downright free!

Face it, we all benefit from increased membership. Each new member is a potential new friend or team mate at the next tournament you attend. Each new member will bring skills and insights into the organization that may be valuable (or at least interesting) at some future time.

If the USBA is going to grow, then it is up to us as members to promote it, whenever able to. We can't sit back and expect someone else to do it for us.

I'm sure that there are many other ways of promoting the USBA that I haven't even considered. If you have some, then send them in and let us hear about them. They may be ideas that the rest of us can use!

MORE FAIRY TALES COME TRUE

1989 was a tremendous year for MTA100. The World Record was shattered several times and dozens of near record scores proliferated at several 1989 tournaments.

In the USA, Steve Kavanaugh set a World Record at the Western Oregon tournament on July 23 with a time of 51.28 sec. Chicago Bob and Reverend Jim almost set records with times of 49.01 sec. and 47.07 sec. Betsylew Miale dropped a flight of more than a minute in the 50 metre circle at the Portland tournament on September 17. Garry Lamothe set a US record with a time of 54.09 seconds at the third Team Gel Tournament in Connecticut on September 23.

In Europe, Udo Wenning bested Steve Kavanaugh's World Record score on August 26 with a flight of 1 minute & 1.15 seconds at the Swiss Nationals in Geneva.

Two weeks later, Fridolin Frost broke the World Record again with the fabulous time of 1 minute & 24.67 seconds. He set the record with an MTA of his own construction at the European Championships in Evry, France. This hot young 17 year old competitor from West Germany is the European analog to America's Chet Snouffer and Australia's Rob Croll; and he's only just a pup. He dominated European competition this summer taking overall honors at both the European Championships and the West German Travemunde Cup. He was a major force in West Germany's close second place finish at the International Team Cup this past June.

In MTA unlimited, excellent times were also registered. The top flight in the USA was Ray Laurent's throw and catch of 2 minutes & 48 seconds. Jim Jordan let a 13 minute flight get away without a catch. Both of these occurred at the Hampton tournament on May 20. Spectacular times were found in Europe too with Thomas Munch missing the catch on a better than 5 minute flight at the European Championships in Evry on September 10. Two days earlier, Eric Darnell managed a spectacular flight of more than 4 minutes, with a catch. Volker Behrens lost one of his new Paxolin-MTA boomerangs to the jet stream god when it disappeared from sight after

only 2 1/2 minutes.

Also for the record books are two additional accomplishments by West German throwers: the European distance record of 117 metres was set by Volker Behrens at the European Championships in Evry on September 10. Ulrich Roos, the new editor of the DBC Info journal set a new world record in Fast Catch using a 4 mm thick undercut and weighted tri-blader (*Schwaben Blitz Model*) of his own creation. The record was set in a competition held in Hailfingen, West Germany on October 1, 1989. The 30 year old psychology student had two sub-30-second rounds in the same competition: 18.21 seconds and 18.74 seconds. Wind conditions were near perfect with occasional light breezes at 11:00 A.M.

Chet Snouffer set a new world record in Juggling with 89 catches at the USBA Nationals in Gunnison, Colorado last August. This record had been fixed at 69 since Bob Burwell dazzled the crowd at the 1982 USBA Nationals in Fairfax, Va.

Matthieu Weber of Switzerland set a European 2-bladed Fast Catch record with a time of 19.21 sec, and made 64 catches in the Endurance event, all in the same tournament in France this past November 11. He also did Super Catch with 7 fast catches under the MTA. Congratulations to Matthieu as a top Swiss thrower!!!

SUPER CATCH HONOR ROLL

Ted Bailey (6)
Rob Croll (7)
Eric Darnell
Doug DuFresne
John Flynn
Torsten Fredrich
Fridolin Frost (6)
Mike Forrester
Michael Girvin
Rob Greer
Thomas Hartmann
Axel Heckner
Dennis Joyce
John Koehler
Uli Konzelmann (8)
Jeff LaCount
Ray Laurent
Gerrit Lemkau
Roger Perry
Barnaby Ruhe
Larry Ruhf
Chet Snouffer
Olivier Vouktchevitch
Matthieu Weber (7)
{ (#): No. of fast catches if more than 5 }

BOOMS IN URUGUAY

Richard Harrison sent in a charming letter that one of his customers (Tomas Thompson) had sent to him about an adventure he was having in the South American country of Uruguay. Excerpts from his letter are provided below:

"I have introduced booms to numerous people and met one fellow who makes 'rangs' and has become one of my closest friends. His biggest problem is getting plywood. The wood he uses, when he can find any at all, is very poor quality and most of the time has been used to form concrete or something similar. What is especially amazing to me is that he had never seen anything other than a plastic \$4 boom that someone from Brazil showed him. Also, he didn't even know how to toss a boom. He couldn't believe it when on my first toss of his 'rang', it returned nicely. He didn't even know that his 'rangs' worked.

When I opened my 'rang box to show him a few of mine, he about died! He marveled over each one. I finally got him off of his bottom and out of my kit after about two

hours of fondling each boom I had taken to the beach that day.

I live on the beach here in Montevideo and it is dangerous for folks and 'rangs to toss anything with a range over 35/40 metres. So my friend (Ignacio) and I headed for the countryside via bus. As soon as we saw the open range of Southern Uruguay, we got the driver to stop the bus and let us off. Ignacio flipped when we worked our way up to the distance booms: Spinbak 55, Delicate Arch, and one of my favorites, my Herb Smith "Ninja Bud". We threw everything in my kit! After about 4 hours (?) of throwing these monster 'rangs, we gave lessons to about 10 boys who were the bravest of the 40+ people who had gathered to watch.

We finally drug ourselves back to the highway after dark and hailed the first bus back to the city. Enroute home, I told Ignacio that there was a shop in the States that specialized in booms. He couldn't believe it! But when I offered him a B'Man catalog, he looked like I had just given him everything you offer.

I told him my mother was coming to Uruguay at the end of November (Thanksgiving) and could bring 'rangs to us. With no hesitation, he wanted a "Spinbak 55". Thus, I would like to place another order! "

BREAKING WORLD RECORD BARRIERS !!!



Fridolin Frost Set a New World Record in MTA₁₀₀

Ulrich Roos, a 30 year old Psychologist from West Germany (lower left), recently smashed the Fast Catch Barrier, previously held by John Flynn, for a new world record time of 18.21 seconds. The boomerang he used is illustrated below at a reduction of 64%. Note the lead weight in the tips and the undercutting style.

Fridolin Frost (upper left) was the last to smash the MTA₁₀₀ world record this year with the fabulous time of 1 minute & 24.67 seconds. Fridolin is terrorizing the boomerang community at the ripe old age of 17.

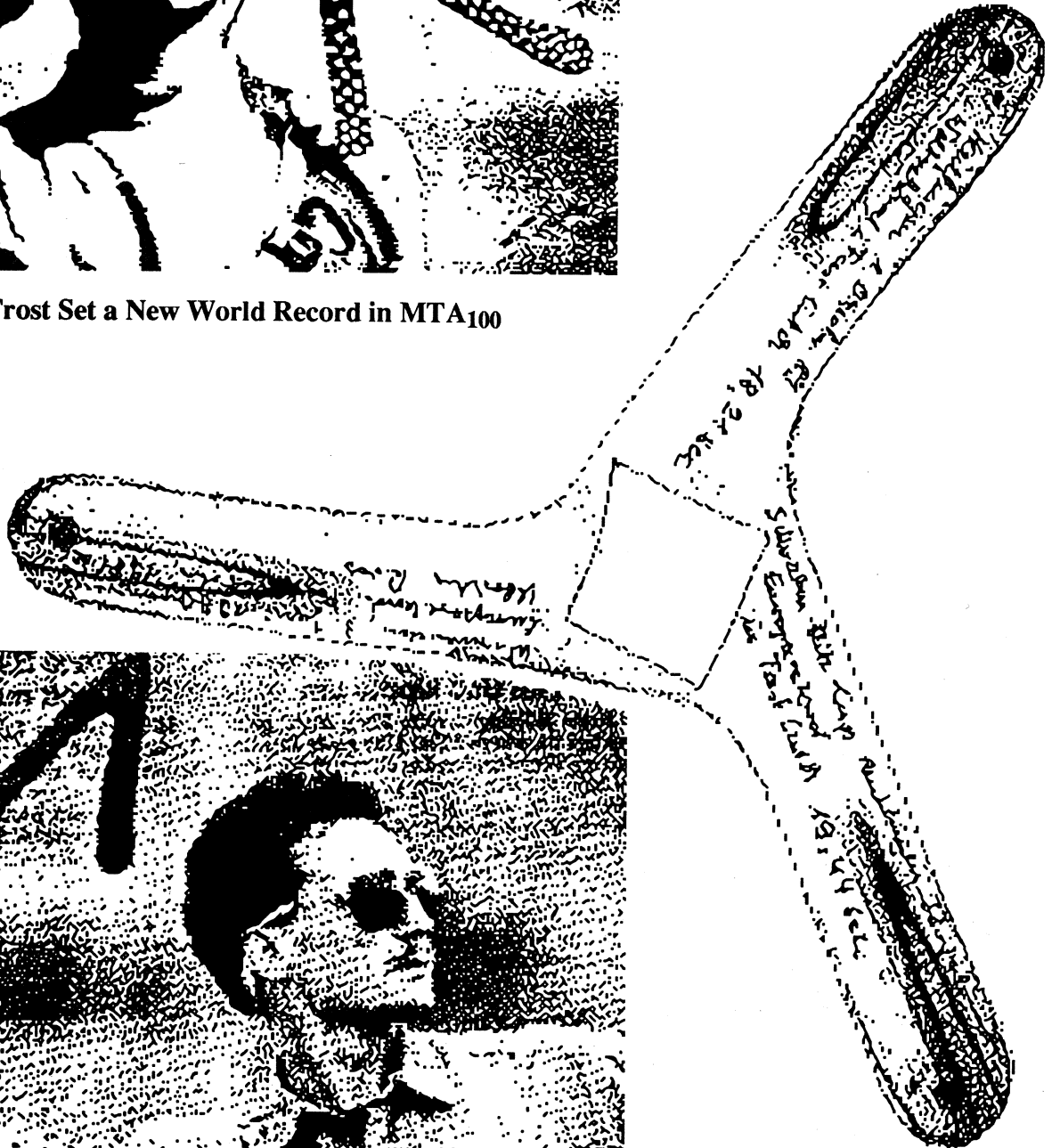

Ulrich Roos Set a New World Record in Fast Catch

The Under Side of the Tri-Blader Fast Catch Used by Ulrich is Illustrated Above

THE CONSECUTIVE CATCH EVENT (another cartoon by Olivier Vouktchevitch)

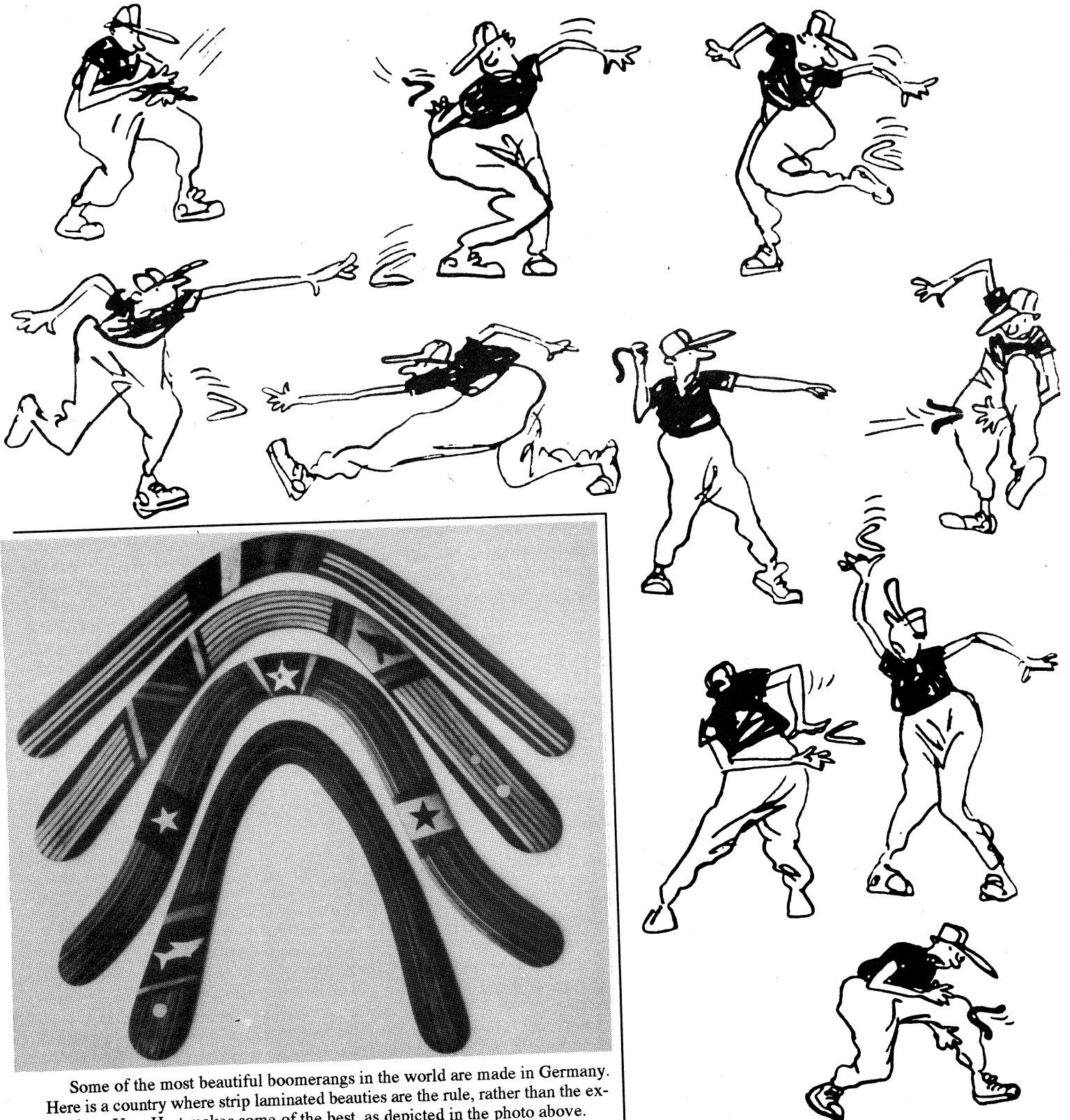

Some of the most beautiful boomerangs in the world are made in Germany. Here is a country where strip laminated beauties are the rule, rather than the exception. Uwe Hast makes some of the best, as depicted in the photo above. These jewels are laminated with exotic woods and inlaid with precious metals.

USBA RATING SYSTEM OVERALL 1989 RANKING

Many thanks to John Flynn for compiling the 1989 USBA Rating System. A summary of the top ten rated competitors is presented below. The complete results are available by mailing a SASE with a written request to: USBA; P.O. Box 182; Delaware, Oh. 43015.

OVERALL 1989 RANKING

Rank	Competitor
1	C. Snouffer
2	M. Girvin
3	G. Snouffer
4	J. LaCount
4	B. Ruhe
6	R. Parkins
7	M. Weber
8	John Flynn
9	Mole Man
10	D. DuFresne



ALAMO Rent A Car

Alamo Rent A Car has extended USBA an Association Membership Program so that USBA members can obtain discount rates on automobile rentals whenever they travel. If you are a member and do not have a card, send a SASE with a request for one to:

USBA
P.O. Box 182
Delaware, Ohio 43015

Twenty four hour (minimum) advanced reservations are required for membership rentals. You can reserve a car without a card by calling 1-800-732-3232 and providing them with the request plan identification: **BY 209311**. Have your credit card number available.

JOIN THE BOOMERANG ASSOC. OF AUSTRALIA

You can join the Boomerang Association of Australia (BAA) by mailing a check for (Aust.) \$30 + \$5 initiation fee to the following address:

BAA Treasurer
P.O. Box 155
Barooga, N.S.W. 3644
Australia



OH MY GOSH,
THE '90'S
ARE HERE!!

GREEN MOUNTAIN BOOMERANGS

MADE BY JOHN FLYNN

- * FAST CATCH/ENDURANCE
- * AUSTRALIAN ROUND
- * DOUBLERS
- * MORE...

SEND FOR FREE BROCHURE

P.O. BOX 181
HARTFORD, VERMONT 05047

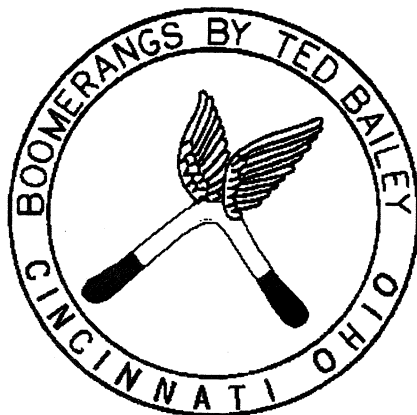

Ted Bailey
9611 Hollyleaf Circle
Cincinnati, Oh. 45215

Write today for a price listing of my competition and collectible boomerang products. I specialize in MTA boomerangs. Items in stock include sticks by Bob Burwell & Mickey Kinley. I also have a small supply of the new plastic boomerang by John Jordan of England. I also have special art boomerangs by John Gibney of Australia at a low cost.

DAN RUSSELL

P.O. Box 84895
San Diego, Ca. 92138
Write and inquire about Dan's source of 5mm 10-ply Finish Birch and Cyalume capsules.

FREE CATALOG! 1989 II THE BOOMERANG MAN RICH HARRISON'S ANNUAL CATALOG

"Giving fast, personal service since 1975!"

<< THE BOOMERANG MAN >>
1806 North 3rd Street
Rm #R
Monroe, Louisiana 71201
(318)-325-8157



A T-SHIRT CLEARING HOUSE ?

Hear Ye! Hear Ye! At last there is a place for tournament directors to unload their surplus T-shirts (and other promotional items such as posters & decals); and a place for collectors to buy promotional items that they missed when they didn't go to all the tournaments. Call Richard Harrison, The B'Man, at (318)-325-8157, or write to him at the address listed to the left for more information. Yes, B'Man even has the ever popular official USBA T-shirts.

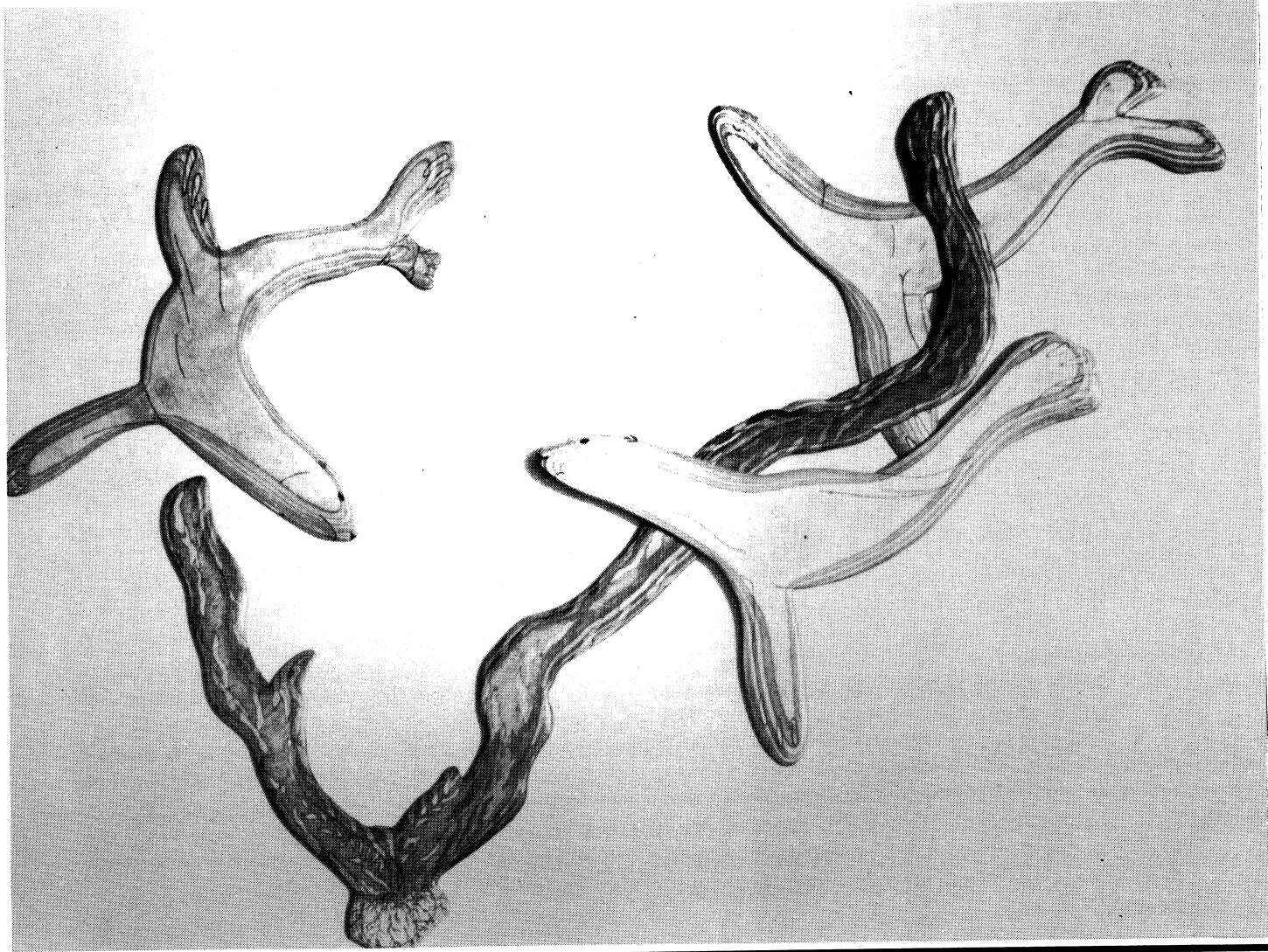

SEAL SCENE (a collection of five boomerangs); by ALAN SCOTT CRAIG

Alan Scott Craig is a boomerang artist, crafting superb animal art boomerangs in his Thousand Oaks, California studio. The "Double Parrots" boomerang on the front cover and the "Seal Scene" illustrated above are some of his works of art. Alan's name is not unknown to the boomerang world. He is well known for throwing boomerangs in the movie "The Baghdad Cafe". Alan has donated both the "Double Parrot" and the five boomerang "Seal Scene" set to the USBA to raise money in a mail auction. The demand for these boomerang sets has exceeded the supply over the past year due to Alan's exclusive *California Art* clientele. Here is a chance to help USBA and add collectable art to your collection. To bid on either boomerang set, send three bids: low, medium & high to:

USBA AUCTION
P.O. Box 182
Delaware, Oh. 43015

Your lowest bid will be considered first. If no one exceeds your minimum bid, the boomerang set will be yours. If your minimum bid is exceeded by another bidder, your medium bid will be considered. Finally, if your medium bid is exceeded by another bidder, your highest bid will be considered. Final bids must be post-

marked by February 1, 1990. You will be notified by mail if you have a winning bid. You can then mail a check or money order to the USBA address and the boomerang(s) will be mailed to you. Here is a once in a lifetime opportunity to get such collectables at any price. Mail your bid(s) today!!!

1990 USBA NATIONALS

The 1990 USBA Nationals are tentatively scheduled to be held in St. Louis, Missouri over the Memorial Day weekend this Spring. Tom Fitzgerald of the St. Louis Boomerang Club is the prime contact for the big one of the year. For more information, contact Tom at (314)-839-1604 or write to the address listed below:

Tom Fitzgerald
1159 Holly River
Florissant, Mo. 63031

USBA INFORMATION PAGE

Many Happy Returns

Circulation: 600 Worldwide.
Published by the:

U. S. Boomerang Association
P.O. Box 182
Delaware, Ohio 43015

Editor/Art Director:
Ted Bailey

Publishing Director:
Jim Jordan

Advertising Director:
John Flynn

Mechanical Measurements:
Image area: 9.5" deep by 7.5"
wide; 3 columns to a page; width
of a column: 2.25".

Advertising Rates:

Full Page	\$200
2 Columns	\$150
1/2 Page	\$115
1 Column	\$80
Per Column inch	\$10

10% discount for four consecutive issues. Camera-ready copy preferred. Composition billed at \$10 per hour. Publisher reserves the right to refuse any advertisement or cancel a contract without reason. Mail all advertisements to:

John Flynn
52 Christian St.
White River Jct., Vt. 05001

The deadline for advertising is March 1 for the Spring issue; June 1 for the Summer issue; September 1 for the Fall issue; and December 1 for the Winter issue. Early ads with payment will receive the best placement.

USBA INFORMATION

The USBA provides services other than this newsletter. Various information listings can be obtained through the USBA headquarters. These include information on wood/materials for making booms; domestic and international clubs; manufacturers and distributors of boomerangs; rules, regulations, and bylaws. A sample of catalogs by various distributors can be obtained by mailing \$2 to USBA headquarters. Domestic members are entitled to receive these listings simply by sending a SASE to USBA headquarters (Overseas members - please send \$1 for each listing required).

USBA
P.O. Box 182
Delaware, Ohio 43015

USBA VIDEO ARCHIVES

Collecting . . Editing . . Sales

Garry Lamothe
18 St. James Ave.
Easthampton, Ma. 01027

Write for a price listing of selected titles including: historical tournament reviews, domestic & overseas shows; scientific and ethnographic materials; etc.

NEWSLETTER SUBMITTALS

All submittals to this newsletter should be mailed to the editor:

Ted Bailey
9611 Hollyleaf Circle
Cincinnati, Oh. 45241

The deadline for submittals is the same as for advertising; or whenever that issue fills up. Get you articles in early. Material should include print quality art or photos. The editor reserves the right to edit all materials.

MEMBERSHIP INFORMATION

All membership dues should be paid by check or money order in \$\$USAS\$. Make checks payable to: U.S.B.A. Domestic and Canadian memberships are \$10 per year or \$150 for life. Overseas dues are \$20 per year or \$250 for life. Check your newsletter expiration season/year which is printed on your mailing label. Mail all checks or money orders to the address below:

U. S. Boomerang Assoc.
P.O. Box 182
Delaware, Ohio 43015

USBA BOARD OF DIRECTORS

President

Betsy Lew Miale
8019 234th S.W. #214
Edmonds, Wa. 98020

Vice-President

Chet Snouffer
51 Troy Road
Delaware, Ohio 43015

Treasurer

John Flynn
52 Christian St.
White River Junction, Vt. 05001

Secretary

Gregg Snouffer
340 Troy Road
Delaware, Ohio 43015

Directors

John Derden
9 Cole Grove Drive
Swainsboro, Ga. 30401

Jim Jordan
11813 Silent Valley Rd.
Gaithersburg, Md. 20878

Dean A. R. Kelly
3350 Neef Ave. S.E.
Salem, Or. 97302

John Koehler
17121 Spates Hill Rd.
Pooleville, Md. 20837

Garry Lamothe
18 St. James Ave.
Easthampton, Ma. 01027



PRINTED MATTER

UNITED STATES BOOMERANG ASSOCIATION
P.O. Box 182
Delaware, Ohio 43015
U.S.A.

PLEASE NOTE: The Spring issue of MHR will be early this year because of the Spring date for the USBA Nationals. Tournament directors need to notify the editor of MHR ASAP of date and location of all 1990 tournaments in order to get them listed in the Spring issue. Also needed is a bid for the 1991 USBA Nationals. Potential tournament directors need to contact the VP (Chet) of their intentions to host the 1991 Nationals ASAP. It is requested that an August date be targeted.

USBA TOURNAMENT HOTLINE:
(619)-298-4283



**Please note that your last issue of the USBA news-
letter is printed on your mailing label.**

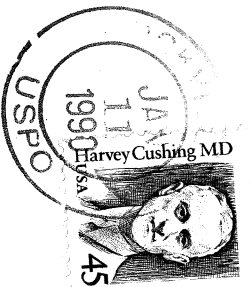

Date M. Riendeau
P.O. Box 484
Jackson, CA 95642
Last Issue: #41, Winter 1990