

Many Happy Returns

Issue Number 54 An International Publication of the United States Boomerang Association

Spring 1993

B
O
O
M
E
R
A
N
G

A
R
T



F
R
O
M

B
U
L
G
A
R
I
A



★ PRESIDENT'S COLUMN ★

by Jim Jordan

As we are fast approaching the 1993 tournament season, it is appropriate that you understand the following:

1993 Rules Changes: No 1993 rules change recommendations were submitted to **Doug DuFresne** as solicited in MHR #53. The Board did vote to keep MTA₁₀₀ as it was in 1992 with four throws. Therefore, the rules for 1993 will remain as published in the Spring 1992 issue of MHR (#50).

1994 Rules Changes: **Doug DuFresne** has decided to resign from the rules efforts. Therefore, future rule change recommendations should be submitted to me (preferably on a separate sheet of paper). All suggestions will be considered by the board for the 1994 season.

Novice Division: **Betsylew Miale-Gix** and **Norm Kern** submitted Novice Division proposals and **Bud Pell** submitted a proposal for *Junior/Open/Senior* divisions. The merits of each proposal are being considered by a committee led by **Betsylew Miale-Gix**.

1993 Tournament Directors:
Warning - The rules require the tournament directors to inform the USBA President of the date, rain date (if any), location, and point of contact at least 60 days prior to the tournament. At least 30 days prior to the tournament, the tournament director must inform the USBA President of the exact location, starting time, nominees for head judge (first choice and two alternatives), events to be held according to USBA rules, condition under which the rain date will be used, and order of events. I prefer to be notified in writing or at least when I am capable of writing the

information down myself. Failure to comply with the above requirements will result in the tournament being declared a non-USBA event (no ratings). In addition, tournament directors are requested to submit results to the USBA President within 32 days of the completion of the tournament. It is very important that tournament directors comply with these requirements to allow timely distribution of the results to the MHR editor, competition yearbook editor, and ratings compiler. Failure to submit the tournament results within 32 days can result in the disqualification of all scores from the USBA rating system.

Insurance: **Betsylew Miale-Gix** is renewing the USBA tournament insurance for 1993. This insurance is designed to protect the USBA, the thrower, and the owner of the field for \$1,000,000. She has requested that all tournament directors write or call her now about their intentions to purchase competition insurance. It is recommended that all tournament directors obtain insurance coverage. The cost per 1993 tournament is \$53.50. Payment (as well as the name of the owner of the field) should be sent to **John Flynn** to obtain an insurance voucher.

Team Rules: The board is reviewing USBA team rules submitted by **Michael Girvin**. Michael has also set up a team tournament on 29 March. A motion was made to adopt Michael's rules on a trial basis for 1993 where team tournament directors will be requested to solicit comments from the team competitors. A trial run will work out the kinks and allow the competitors some input to the rules. If the board approves this motion, copies of the team rules may be obtained from me on request.

What's In This Issue!

Page	Contents
2	President's Column
3	USBA Store
4	Repairing MTA Booms
6	Boomerang Lay Down
9	Gel XMAS Competition
10	1993 Boom Season
14	Bits & Pieces
23	USBA Information

Membership Drive: In support of my challenge to pay one year's USBA membership to anyone who sponsors 10 or more new USBA members by the August 1993 Open/Nationals, **Jim Mayfield/Colorado Boomerangs** is offering both his 4mm and regular *Seagull*, and his tri-blader at a 25% discount (\$9, \$11.50, \$13.50 respectively, plus shipping) to any USBA member who may encounter beginners. These are excellent boomerangs for teaching at a bargain. Thanks Jim, for your support.

Editor's Note

All boomerang clubs, manufacturers and distributors should send club or product information to the editor at once. The USBA listings are being updated now. Don't forget to also send several of your updated catalogs to Chet Snouffer for the USBA catalog mailing service.

The USBA Store

The USBA Store is open for business! Where else can you find a broad selection of boomerang books and paraphernalia.

I'm always looking for new items that will be of interest to our members. Send me your suggestions for what you'd like to see here. I've already received some suggestions and am looking into them now.

I am currently working to consolidate back issues of Many Happy Returns so the USBA Store will be the only place you need to go to find those issues you've missed.

All proceeds from sales will go directly toward store operating expenses and the support of the USBA as a whole. This makes buying stuff from the store of double benefit to you! You not only get top quality merchandise at outstanding prices, but you also support the USBA!

All checks and money orders should be made out to **Dean A. Kelly** (at least until I get a bank account opened for the store). Make sure to clearly state the items wanted for each order.

For a complete list of what is currently available in stock, send a SASE (USA) or \$1 (overseas) to:

**The USBA Store
C/O Dean A. Kelly
3350 Neef Ave. SE
Salem, Or. 97302**

Questions? Call: (503)-581-8050

All prices quoted are in \$USA\$ and include S&H charges to the USA or Canada. Overseas orders must include \$2 extra for surface or \$4 extra for Airmail per item. Back issue newsletters are \$1 additional for surface mail and \$2 extra for Airmail per newsletter.

USBA Store Stock Availability - Prices Each Item:

\$3.50	USBA Patches
\$1.50	USBA Decals
\$6.00	"Boomerang": a book by Ben Ruhe
\$8.00	"The Big Book About Boomerangs": a book by H. L. Mayhew*
\$4.00	"The Boomerang": an early pamphlet by B. Ruhe/L. Hawes
\$20.00	Huerer Digital Stopwatch**
\$1.50	"Boom Nekid" Bumper Stickers (only 3 available, order fast)
\$2.50	Back Issues of MHR: # 21-W85; #23-Sm86; #26-Sp86; #27-Sm86; #28-F86; #29-W87; #31-Sm87; #32-F87; #33-W88

* First edition signed by the author.

** high quality Swiss made. A \$50 value. Only 10 are available.

Orders of \$15 or more are eligible for a free issue of MHR. Please indicate your first and second choices.

Wouldn't you love to be seen around town sporting the official T-shirt of the greatest organization in the world? And wouldn't it be even better if you could tell all your admirers that you were the one who designed it?

Think about it. Your design enlivening every major and minor boomerang tournament in the known universe! Well, believe it! It could happen to you!

Announcing the 1993 USBA T-Shirt Design Contest! We're soliciting designs from USBA members for a new T-shirt.

I'd like to get the new T-shirt into production in time for the 1993 Nationals in Seattle, so get crackin' and send in those designs.

Designs will be judged on the basis of artistic creativity, appropriateness and how well suited the design is for mass production.

The winner of the Design Contest will receive a throw stick crafted by Dean Kelly, a free USBA T-shirt from the first batch produced, their signature on every USBA T-shirt made, and recognition in the following issue of Many Happy Returns! Plus fame and glory!

Send all designs to the USBA store address listed above.

REPAIRING BROKEN PLYWOOD MTA BOOMERANGS

by John Flynn

If you are a member of the 3mm plywood MTA generation (before carbon fiber and phenolic), then you have probably had the unpleasant experience of watching one of your favorite MTAs plummet to earth in a wild, accelerating free-fall. Maybe you threw it a bit too sidearm or maybe it was a little too windy for *Ol' Reliable* and she was knocked out of her usually flawless hover. Whatever the reason, what you see is not good.

My old trusty blue Ted Bailey Midi-MTA happened to land on Garry Lamothe's noggin as we were warming up for MTA at the 1990 Nationals in Saint Louis. Garry suffered no damage, but Old Blue was in two pieces. Fortunately, the break was jagged (as opposed to a clean, shearing break). This meant that I could fit the plies back together, with care, and end up with a virtually seamless repair. I immediately put the broken halves in my boomerang bag to prevent further damage to the edges, and epoxied them together when I got home from the Nationals (using the equivalent of Stages I & IV below).

The end result was, amazingly, a better flying MTA, and for the next two years, Old Blue served very well whenever called upon. Then last spring at the Webtown contest, I got

lax working the kinks out of a sore shoulder, threw a bit too sidearm....Deja Vu, except Lamothe's head was mercifully nowhere to be found. Old Blue broke in the same place, except this time it was a clean break along the first epoxy line. This was serious, but since it was/is a special rang, I had to try something. So I decided to attempt a four-stage repair using *Gougeon Brothers "West System"* epoxy and carbon fibers.

Stage I was to re-epoxy the halves together. To hold the shape as close to the original as possible, I cut two small $\frac{1}{8}$ " plywood squares, 1" x 1" and used them as clamping blocks to spread the pressure of the C-clamp. Wax paper was put between the squares and the top and bottom surfaces so the

squares would not be epoxied to the rang (see Figure 1). Once clamped, the two halves could be maneuvered slightly to make sure everything was lined up just right. When it was, it was set so as not to put any pressure on the repair. After several hours of curing, the clamp was loosened and an accurate sighting evaluation was made along the edges of the wing to make sure the tuning was being maintained. At this point it didn't really matter if the 'rang was clamped again as long as no forces were applied to the repair area.

After 24 hours, the epoxy had cured 90%+ so it was time to move on... knowing that any attempt to throw would snap the 'rang again, I treated Old Blue like it was made of glass and carefully flat filed the excess epoxy from both the top and bottom surfaces, barely exposing the plywood through

- 1 - 1" X 1" Squares (not to scale)
- 2 - Wax Paper
- 3 - Epoxy/Carbon Fibres In V-Notches

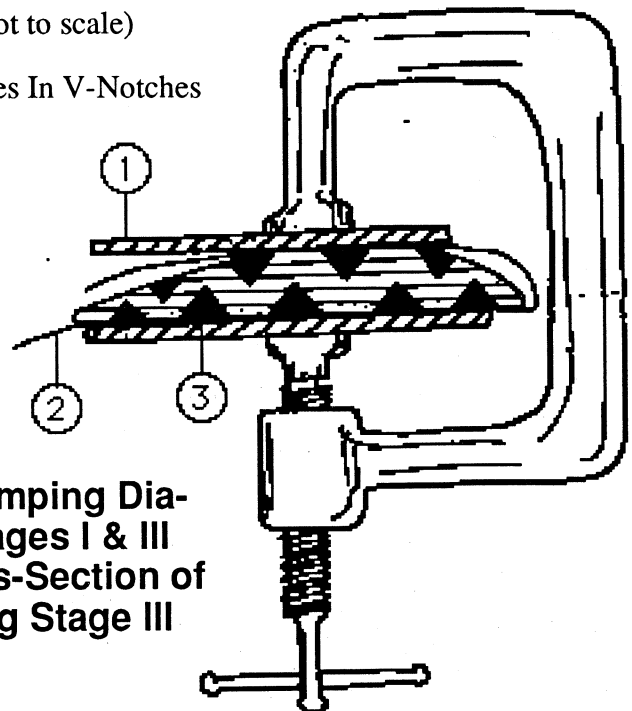

Figure 1 - Clamping Diagram For Stages I & III Showing Cross-Section of Repair During Stage III

the blue paint. This would leave a fresh surface for the epoxy to soak into during Stage III.

Stage II put the 'rang in even greater peril of breaking. Scribing one inch lines on both the airfoil and underside, careful to stagger the spacing (see diagram below). I used a Dremel tool with a small, square-edged bit to rout V-shaped notches into the 'rang to expose fresh plywood and create more surface area. At this point, with nine (9) inch-long notches, any pressure or impact on the break would cause the bond to crack and terminate the repair. Each notch went slightly into the middle ply of the 5-ply rang with the exception of those on the trailing edge where the thickness of the wing was less, and I could only rout 1-2 plies deep. I took care not to break through because important surface area would be lost!!

Stage III involved the Gougeon epoxy and the carbon fibers. I pre-cut eleven (2 extra) segments of fibers, each roughly enough to fill a notch, and laid them out for easy access once my plastic gloves had epoxy on them. After mixing the epoxy and putting a little in each notch to begin to soak in, I laid the carbon fiber segments, smeared with epoxy, into the notches, making sure to squeeze out any trapped air and build the fibers/epoxy up to the level of the original airfoil. I also laid a segment along the length of the break on both the top and bottom surfaces, per-

pendicular to the fibers in the notches for added strength. Then I applied the wax paper, plywood pieces, and clamped it all together as in Stage I.

Twenty-four hours later, Old Blue was dry and out of danger. Again, the flat file was used to remove the excess epoxy and carbon fibers and shape the repair area to the original airfoil. After test flying, Stage IV was to mix one last cup of epoxy to lightly smear on the top and bottom of the repair to seal the repair from moisture (this step can be delayed until there are other items to epoxy, making better use of the mixture).

The following items were used in this repair process; the initial investment is more than two or three new 'rangs, but the process can be used on any wood boomerang. I haven't tried it on other materials. If you find other equipment or bonding materials that also work, then more power to you!!

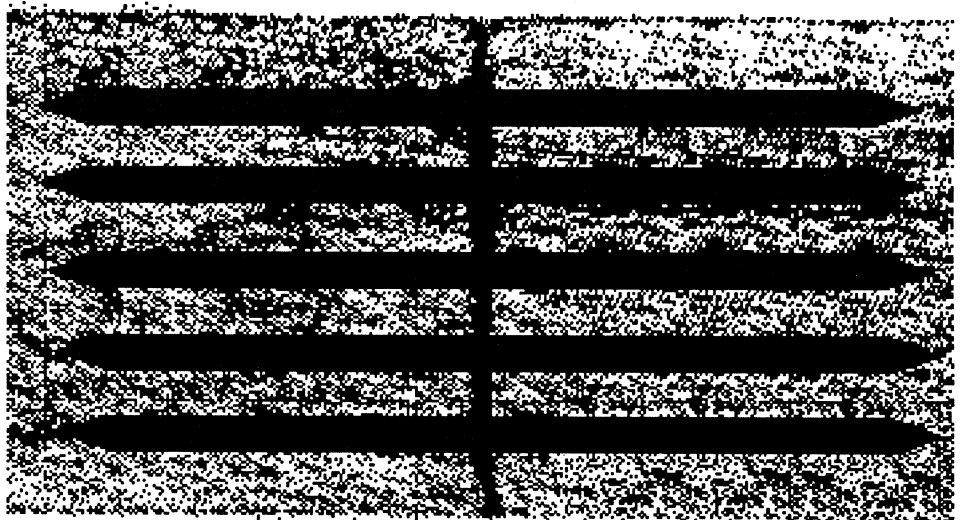

Figure 2 - Enlarged View of MTA Repair Showing Break (vertical line) and Epoxied Dremel Channels (horizontal lines).

Recommended Materials

C-clamp (1)
1" x 1" Plywood 1/8" Thickness
Squares (2)
Wax Paper
Gougeon West System Mini-
Repair Kit (#101-T or #101-6)
includes hardener and resin
packets
Gougeon Mixing Cups
Plastic or Latex Disposable
Gloves (#832)
Mixing Sticks
Gougeon Carbon Fibers
Flat File/Rasp (1)
120-, 320-Grit Sandpaper
Dremel Variable-Speed Hand
Router Tool (1)

A Gougeon Bros. Product Catalog can be obtained from:

**Gougeon Brothers, Inc.
P.O. Box 908
Bay City, Mi 48707**

Other items are available at most building supply or hardware stores. Be sure to read all directions and heed manufacturer's warnings when using these and other products.

An Analysis of the Causes of Boomerang Lay Down

by Peter J. Close

Lay down is a property that most boomerangs demonstrate. A boomerang may be thrown with its plane nearly vertical, but as the boomerang travels it has a tendency to tilt its plane closer to horizontal; it "lays down" as it returns.

Previous work on this topic, especially the running discussion in *The Boomerang Journal*, have mentioned many theories for this phenomenon. All of these theories have merit and the authors forwarding them have written very good descriptions of these lay down factors. I commend them. Unfortunately these physical principles are hard to put numbers to; hence most of the writing has been qualitative rather than quantitative.

This paper is an attempt to summarize the various factors and present a semi-quantitative analysis of their relative importance in lay down.

As a boomerang wing rotates through one revolution it sweeps out a circle. At various points in this circle the wing is producing different amounts of lift. This lift can be summed up around the "lift circle" into a total lift force acting at some distance from the boomerang's center of mass (CM). The torque produced about the CM can

be decomposed into two components that cause two different precessions. One precession brings the boomerang back to its thrower, the other precession is lay down. The ratio of these two torque components equals the ratio of these two precessions. The ratio of lay down precession versus return precession usually ranges between 0 and $1/2$. A ratio of $1/4$ is the typical case, where the boomerang is launched vertically and returns horizontally. This is the ratio we will use for further discussion, since it is a large effect and is quite common.

To aid further discussion let us define the following abbreviations: CM is the center of mass of the boomerang, V is the translational velocity of the CM , ω is the rotational velocity of the boomerang around CM , L is the radial distance from CM to a wing tip, c is the width of the wing cord, and cm is the center of mass of a wing cross-section (see Fig. 1, below). It is also very helpful to consider a boomerang as a disk on which the various aerodynamic forces act. The coordinate system for this disk is defined such that the origin is at CM , V is in the negative x -direction, and a right handed boomerang rotates counter-clockwise (see Fig. 2, p. 7). T_y is

the torque about the y -axis, which causes lay down. T_x is the torque about the x -axis, which causes the boomerang to return. Since the same force creates these torques we can use the distances (a , b) from CM at which the force acts to analyze the torques.

From some involved quantitative analysis, one can show that the lift force acts at a point along the y -axis that ranges from 0 at $V=0$, to about L at $V = 2\omega L$. So the lift force must also act at a distance along the x -axis of $1/4$ of the above range, in order to cause $1/4$ lay down. For argument we will use $2/3 L$ for a and $1/6 L$ for b . This will give a good insight as to which lay down factors are most important.

There are many factors to consider in lay down; eccentricity, wing asymmetries, wake effects, transverse lift moment, wing dihedral, longitudinal lift moment, and the Bernoulli effect. Each of the factors will be discussed individually as if they are the only factor present; this however is not the case. In reality, several if not all, of these factors act at the same time. It is important to note that all of these lay down factors depend on some non-zero translational velocity. Generally, the faster the boomerang travels the faster it lays down.

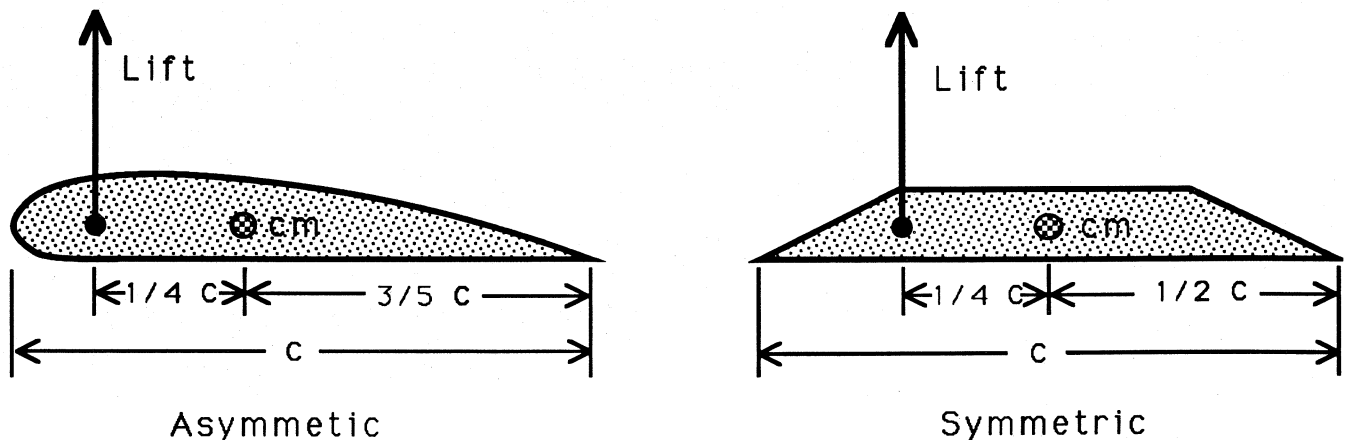

Figure 1 - Airfoil Cross Sections

Eccentricity

Any wing that does not radiate from the center of mass of the boomerang is eccentric. Eccentric wings create lift that is not symmetric about the y-axis, which in turn causes a torque that produces lay down (see Fig. 2a & 2d). If a boomerang has two wings with opposite eccentricity then the effects of their eccentricity will cancel out. Mathematical calculations show that an eccentricity of $1/6 L$ is enough to cause the typical $1/4$ lay down. This then can be a very prominent cause of lay down. One can also use the opposite eccentricity to retard or prevent lay down (see Fig. 2c & 2f).

Asymmetries

When a particular boomerang has wings with opposite eccentric-

ity (most two-bladers) then asymmetries can be a factor in lay down. Asymmetries occur when one wing is different than the other; longer, wider, undercut, twisted, etc. These asymmetries cause the wings to produce a different amount of lift. If everything else is held constant; a wing that is 10% longer will produce about 20% more lift. A wing with an undercut or twisted up leading edge can produce over 20% more lift. A wing that is 10% wider will produce about 10% more lift. These all cause imbalances in the torque about the y-axis and can be a major cause of lay down. Like eccentricity, asymmetries can also be used to retard or prevent lay down. If the lead wing has more lift then the boomerang tends to lay down. If the trailing (dingle)

wing has more lift then lay down is retarded.

Wake Effects

When a wing passes through the air it causes that air to be disturbed. If a second wing passes through this disturbed air it tends to produce less lift, about 20% less. With a boomerang traveling at some positive V each wing has more clean (undisturbed) air in that part of its rotation that occurs in the direction of travel, where $x < 0$ (see Fig. 2). So more lift is produced on the negative x side of the y-axis. That creates a component of torque about the y-axis which produces lay down. This effect depends on the ratio of the translational velocity to the rotational velocity, and the angle between the wings. Wake effects can cause sufficient torque to pro-

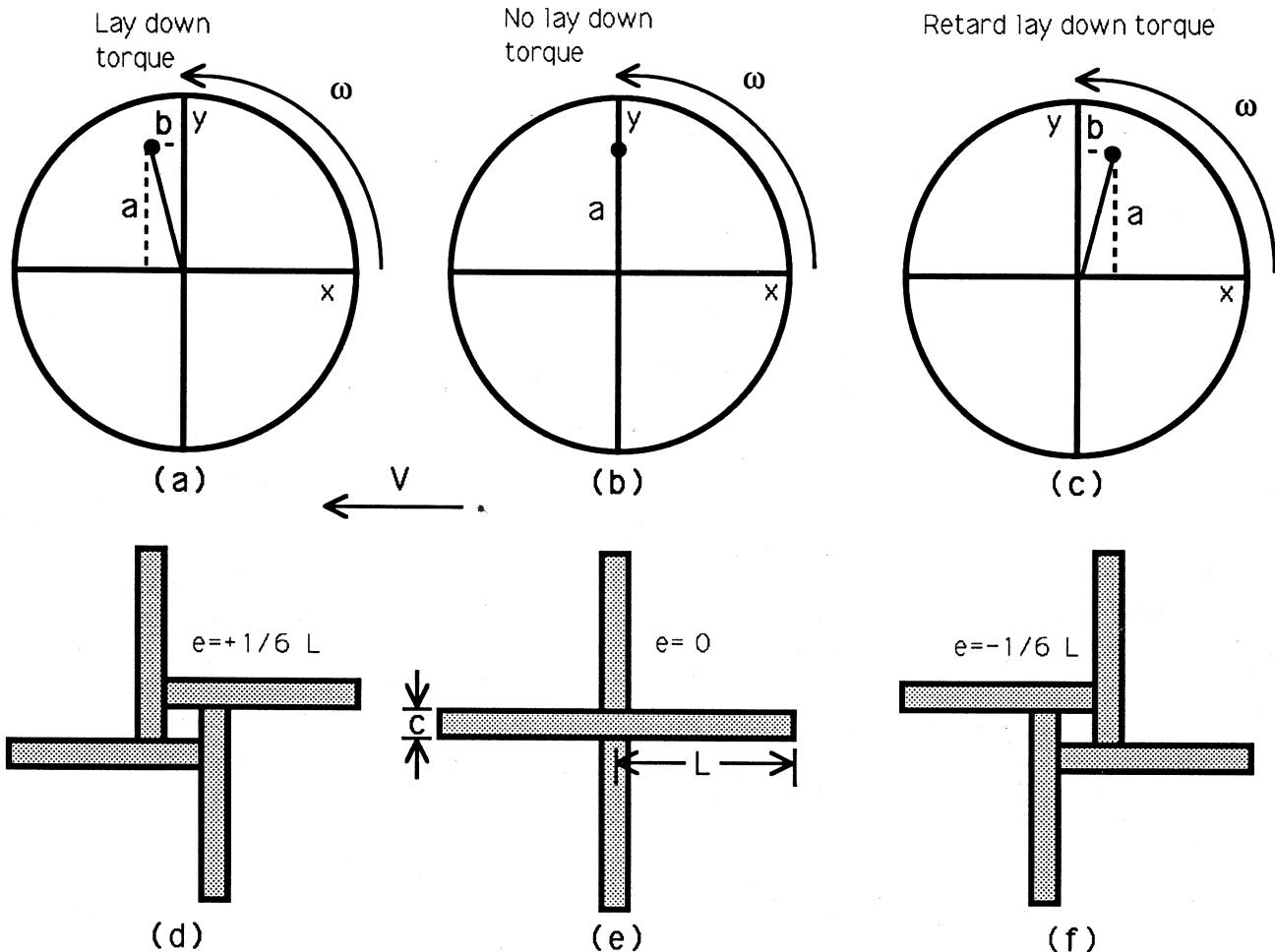

Figure 2 - Lift Applied To Boomerang Disk and Eccentricity

duce $1/4$ lay down. A curious feature of wake effects is that at high velocities, $V > 1.2\omega L$, the torque that produces lay down gets smaller. Wake effects can not be used to retard or prevent lay down.

Transverse Lift Moment

This theory is based on the fact that the center of lift for a particular wing cross-section is not necessarily at cm and thus causes a turning moment. For a symmetric wing cm is halfway between the leading and trailing edges of the wing section (it is more like $2/5$ for most non-symmetric cross-sections). The maximum distance that this force can act along the x -axis is $1/2 c$ (chord length) and $1/4 c$ is more realistic (see Fig. 1, p.6). If we just use $2/3 L$ (span length) as the distance along the y -axis that the force acts, then by some math we discover that the aspect ratio (L/c) of the wing would have to be: $4 * 1/4 c = 2/3 L$, $L/c = 3/2$. This means the wing would need to be $2/3$ as wide as it is long, which is quite rare. Ratios between 4 and 8 are the most common. This doesn't mean to say that center of lift being different than cm does not cause lay down; it is a contributing factor. It does however suggest that this effect does not normally cause $1/4$ lay down. Transverse lift moment will not retard or prevent lay down.

Wing Dihedral

The angle at which a wing is bent up or down is called the dihedral angle or just dihedral. Wing dihedral is taken into account below, in the section on longitudinal lift moment.

Longitudinal Lift Moment

Longitudinal lift is the lift produced by the component of the wind that travels down the length of the wing. If we look at a longitudinal cut away of a boomerang wing we can see that it is also an airfoil (see Fig. 3, below). Maybe not a classic airplane airfoil, but it functions to produce lift just the same. The lift produced is not a function of rotational velocity at all, but is proportional to the translational velocity squared. This lift is usually significantly smaller than transverse lift, but often it produces a rather large torque about the y -axis. Bending up the wing tips (adding dihedral) greatly increases lay down torque without much change in the lift.

The effects of longitudinal lift can be easily tested. Choose a symmetric boomerang that flies a near level circle. I suggest using a Mason cross-stick boomerang made out of a yardstick. Throw the boomerang several times to get use to the throw, its flight path, and how much it lays down. Now bend each wing near the middle to raise the tips up a little. Do not twist the wing. Now throw the boomerang again, just as you threw it before. The boomerang now will not fly level but will have a high peak and return closer to the direction from which it was thrown. If this effect appears small try bending the tips up more. The important thing to note is that the boomerang is laying down more. That is why there is a change in the flight path.

Slight (very hard to see without a straight edge) changes in the dihedral can radically change the amount of lay down, so this is a very important factor in lay down. Longitudinal lift moment can also

be used to retard or prevent lay down.

Bernoulli Effect

This theory involves the fact that if a planar object is held such that its edge points into a steady wind, the planar object will rotate so that the wind strikes it against one side. This effect is quite strong. The trick here is to realize that the Bernoulli effect is just the lifting moment of a wing. This has already been taken into account above in the sections on transverse lift moment and longitudinal lift moment.

Conclusion

There are many factors that cause boomerang lay down: eccentricity, wake effects, wing asymmetries, transverse lift moment, and longitudinal lift moment. With the exception of transverse lift moment all of these factors can cause $1/4$ lay down. Eccentricity, wing asymmetries, and longitudinal lift moment can also be used to retard lay down. Every boomerang has several of these factors contributing to or retarding lay down. Which factor dominates depends on the individual boomerang and flight conditions.

I hope this analysis has been of some aid to the reader in understanding lay down. This is a very simplified version of some results of the research I am presently conducting. Feel free to write or call me, if you would like to discuss the subject further. The best way to advance the science of boomerang flight is an open exchange of ideas, theories, data, and opinions in an atmosphere of mutual support.

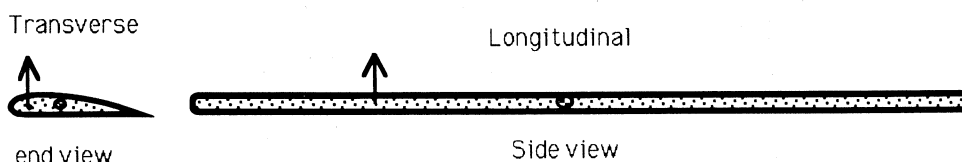

Figure 3 - Boomerang Wings Transverse and Longitudinal Airfoils

Peter Close
P.O. Box 156
Roberts, Wi. 54023
ph: (715) 749-3867

The 8th Annual Team Gel Oakland Christmas Tournament

by Michael "Gel" Girvin

For the 8th year in a row, the boomerang locals celebrated Christmas with a healthy day of boomerang throwing. But this year had a logistical twist. The tournament was not held on Christmas or the day after Christmas like in years past. It was held on New Years Day, 1993. And unlike years past, when California had been strangled by drought, this year liberal amounts of rain had transformed the fields into ankle deep mud swamps. It was announced at the beginning of the Team Tournament that a special trophy would be given to the thrower that fell into the mud the greatest number of times: it was not a question of who got the mud-diast, because every thrower would be covered in mud by the end of this day.

The sun was out. The wind was nice. Twenty Three men and women from Zurich, Chicago, Seattle, Olympia, Portland, and the greater Bay Area formed four teams that competed at the Billy Martin Field throughout the New Years Day. A portable TV was present to keep abreast of all the college Bowl Game scores. The teams, with Veterans equally distributed among them, grouped together and creatively named themselves: Team Something With 93 In It; Team I Don't Know, I Don't Care; Team Monkey Paw; and Team Which Way. Teams then took a vote and decided to participate in Team Accuracy, Team Round Rang Relay, Team Super Catch and Team Butterfly (one person throws and the other teammates try to catch, do a trick catch or hacky by bouncing it off hand or foot to another teammate). Highlights are as follows:

In the event Accuracy, Team Something With 93 In It, featuring Saul Manley, Michael Girvin, Stephanie Martin, Barry Summers and Chris Walcott, stepped into the concentric circles and dotted the scoring zones with fallen boomerangs to earn an impressive 97 points. The speedsters Josh Letine, Peter Pay Rose, Peter Gibson, Mike Fuquewitt, Hirloa Levi and Mark Lee, which made up Team Which Way, ferociously dominated in Round Rang Relay, winning by almost a minute. Team Monkey Paw with Pia Hagan, Ariel Hagan, Joe Miller, Johnny B and Mark Basuino watched fellow teammate Kim Galeazzi rocket a sky high MTA that left the park and Upon returning to earth hit the side of a building and flopped into Kim's hands for the catch, a score of 19 and the win in that event. In the last event, Team Butterfly, Team I Don't Know, I Don't Care, featuring Steve Kavanaugh, Kelly Andrette, Steve Davey, Quinn McFredrick and Hero performed three perfect rounds. Each round had one teammate throwing, one teammate hacky and another teammate completing a trick catch. In the only individual event contested, G-L-O-R-P, Steve K. and Michael G. battled to the end with catches such as Handstand-One-Hand-Clean, In-The-Air-Under-The-Leg-Eagle and Fist Hacky to Elbow Hacky to Head Hacky to Catch with Michael taking the win.

Then the New Years Day Christmas Boomerang Tournament came to an end as the sun set on the smiling, muddy boomerang throwers. They all headed to La-Val's Pizza Palace for the awards ceremony. Boomerang prizes and beautiful awards were given to all the deserving and gutsy throwers, but it was the one special award that everyone had played for: The

Mud Trophy. Seven year-old Ariel Hagan made falling into the mud look simply delightful. She won the Mud Trophy. Everyone cheered and yelled at Ariel's mud and their own. And then the Team Day was over, for now. Until the next time, boomerangs and friends, mix it up at Billy Martin Field in Oakland, CA, March 27th and 28th, STAY RAD.

TEAM GEL

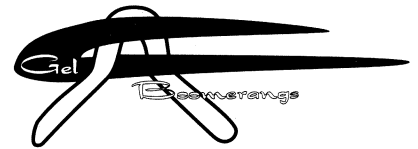

- 19 Models Available
- Beginner to Competition Expert Rangs
- NEW Phenolic MTA's, Tri-Doublers and Aussie Round Booms

Send for Free Color Catalog

GEL BOOMERANGS
2124 KITTREDGE STREET #61
BERKELEY, CALIFORNIA 94704 USA
(510) 658-2469

HERB SMITH BOOMERANGS for sale

Send S.A.S.E. for info
San Francisco
Boomerang School
127 Knollview Way
San Francisco, CA 94131
(415)-550-6746

BOOMERANG SEASON 1993



The tournament season is upon us and many fine tournaments are already scheduled for 1993. All tournament directors should make sure that they read the USBA President's column on page 2 for important information on rules for the competition season.

Betsylew Miale-Gix informed MHR that committee efforts are underway to define new rules for novice/advanced thrower interfacing at tournaments. If the rules are to be implemented for 1993, tournament directors will be notified. If the rules are to be implemented in 1994, then details will be forthcoming in a future issue of MHR.

Michael Girvin has supplied MHR with the first edition of the new USBA team competition rules. A copy is attached as an insert in this publication.

Rob Parkins informs MHR that the 1st edition (1992) of *The USBA Competition Yearbook* is complete and will be available at approximately the same time as this issue of MHR. All USBA members will receive a copy.

The first rated tournament of the season will be *The 9th Annual Team Gel Oakland USBA Tournament* on March 27 in Oakland, California. A team tournament is scheduled on the following day at the Stinson Beach Regional Park. For more information, call **Michael Girvin** at (510)-658-2469 or write to the following address:

Michael Girvin
2124 Kittredge St. #61
Berkeley, Ca. 94704

The *1993 World Boomerang Design Competition* will be held in Chatham, Ontario, Canada on April 23/24. Although this is not a throwing event, boomerang craftsmen from around the world have sent in boomerangs to be judged in several categories. Manufacturers are also invited to come and sell their wares and view wood working exhibits and sales. A drawing will also be held for the \$2,500 Cryderman boomerang. For more information on this event, call **John Cryderman** at (519)-351-8344 ASAP or write to:

John Cryderman
136 Thames St.
Chatham, Ontario N7L 2Y8
Canada

The Annual South Georgia Boomerang Club Tournament will be held on April 24 in Swainsboro. Prizes will include special competition boomerangs by top USA craftsmen. For more information, call **John Derden** at (912)-237-7207 or write to:

John Derden
Rt. 4; Box 381
Swainsboro, Ga. 30401

The *8th Annual Team Gel/Evergreen State College Rad Test* will be held in Olympia, Wa. on May 1 & 2. The USBA tournament will begin at 8:30 AM on May 1. The Team Gel tournament will be held at 11:30 AM on May 2. For more information, call **Kelly Andretti** at (206)-866-6519 or write to the following address:

Kelly S. Croman-Andretti
P. O. Box 995
Olympia, Wa. 98507-0995

The date for the next annual *Toss Across America* has been set for May 15, 1993. Make plans to host a throw as soon as possible and pass the information on to TAA organizer **Betsylew Miale-Gix** at the following address:

Betsylew Miale-Gix
3351 236th St. S. W.
Brier, Wa. 98036

Chet Snouffer notified MHR that the TAA demo & workshop previously scheduled at the *Mohican Wilderness* on May 15 has been cancelled due to inadvertent site/event conflicts. Sorry Buck-eye throwers.

l'Ovni Boomerang Club is sponsoring their third annual informal season warm up throw on May 15/16. For more information, call **Gilles Landry** in France at 30 99 16 64 or write to:

Gilles Landry
4 allée de Bretagne
78130 Les Mureaux
France

The *6th Annual Gateway Boomerang Classic* will be held in St. Louis on May 30. For more infor-

mation, call **Tom Fitzgerald** at (314)-839-1604 or write to the following address:

Tom Fitzgerald
1159 Holly River Dr.
Florissant, Mo. 63031

There will be another Gel tournament in California this spring. This time it is *The 9.5th Annual Team Gel Oakland USBA Tournament* which will be held over the 5/6 June weekend in Oakland. Both individual and team events are scheduled. For more information, call **Michael Girvin** at (510)-658-2469 or write to:

Michael Girvin
2124 Kittredge St. #61
Berkeley, Ca. 94704

Jay Emerson announces that the first USBA rated Michigan tournament will be held on June 19 in the vicinity of Detroit. For more information, call Jay at (313)-347-3864 or write to:

Jay Emerson
1415 Nardeer
Novi, Mi. 48374

The annual *Thuba Tournament* will be held on June 20. This is less than a 3 hour drive from the previous day's event and will be an excellent opportunity for the thrower to get two ratings on a weekend. For more info on this event, call **Sean Marquardt** at (219)-486-0503 or write to:

Sean Marquardt
5415 Old Dover Blvd. #5
Ft. Wayne, In. 46835

Eckhard Mawick writes to announce the *First Lieler-Woche-Boomerang-Cup* on Sunday, June 20 in Kiel which is located in North Germany on the Baltic Sea. The tournament will be held at the same time as a major Baltic sailing

event. Aussie Round, MTA, F/C and various Gel-style events (such as blindfold catching ala **Matt Hannifin**) will be contested. For further information, contact:

Eckhard Mawick
Wakenitzmauer 64
2400 Luebeck 1
Germany

The Rennes Tournament will be held in Crozon, France on 10/11 July. For more information, call **Freddie Resmond Richard** at: 99 67 60 04 or write to:

Freddie Resmond Richard
17 Square A Fergent #93
35000 Rennes
France

A tournament is tentatively scheduled at the *Kimball Union Academy* in Meriden, New Hampshire on 17 July. For more information, call **John Flynn** at (802)-296-2158 or write to:

John Flynn
52 Christian St.
White River Jct., Vt. 05001

The 6th Annual Western Oregon Boomerang Roundup is scheduled to take place in Salem, Oregon on 25 July. There will be a \$5 registration fee. A practice throw will take place on the previous day. This is an excellent opportunity to warm up for the USBA National that take place on the following weekend. For more information, call **Dean Kelly** at (503)-581-8050 or write to:

Dean Kelly
3350 Neef Ave. S.E.
Salem, Or. 97302

The USBA Open/Nationals will take place on July 31 through August 2 in Redmond, Washington. Throwers should plan on flying in

to the Seattle/Tacoma Airport. Throwers will have 16 well groomed soccer fields at their disposal. An insert with details accompanies this issue. For more information, call **Will and Betsylew Miale Gix** at (216)-485-1672 or write to the following address:

Will & Betsylew Miale Gix
3351 235th St. S.W.
Brier, Wa. 98036

The 14th Annual Free Throwers Fling is expected to be held on August 7 in Delaware, Ohio. For more information, call **Chet Snouffer** at (614)-363-8332 or write to the following address:

Chet Snouffer
51 Troy Rd.
Delaware, Oh. 43015

The *CVNRA Tournament* will be held at the Cuyahoga Valley National Recreation Area near Cleveland, Ohio on August 8. For more information, call **Dave Boehm** at: (216)-289-6324 or write to the following address:

David Boehm
P. O. Box 17385
Euclid, Oh. 44117

The 5th annual Novice/Veteran Team Tournament will be held in the Detroit, Michigan area on September 12. The exact location will be determined in the near future. For more information, call **Norm Kern** at (313)-645-9308 or write to the following address:

Norm Kern
1640 Haynes
Birmingham, Mi. 48009-1605

The Second Mighty Willamette Tournament is scheduled to be held on 12 September. For more information, contact **T. W. Smith** at (503)-942-3167 or write to:

T. W. Smith
P. O. Box 11332
Eugene, Or. 97440

The 9th Annual Summer's Final Fling is scheduled to take place in Portland, Oregon on 19 September. For more information, call **Doug DuFresne** at (503)-292-4316 or write to:

Doug DuFresne
4235 S.W. Crestwood Dr.
Portland, Or. 97225

The "1st" 9th Annual Hampton Boomerang Tournament is scheduled to take place on 4 September at the Mason Cooper School. Registration starts at 7:30 AM. For more information, call **Dennis Joyce** at (804)-851-7615 or write to the following address:

Dennis Joyce
111 Drummond's Way
Hampton, Va. 23669

In this issue, the editor initiates the first annual survey of equipment used by the competitors who ranked number one in each event category. The following report will provide the reader with information on how s/he can obtain state of the art equipment for the following (1993) season.

In the *Consecutive Catch* event, **Michael Girvin** took top honors in the best, placing & overall rating categories. Michael tied for median score with **Chet Snouffer** and **Ben Owen**. Michael's favorite boom for this event is his *Phenolic Carlotta* for all catches except for foot catching. In windy conditions, Michael places a penny midway down each arm and he places a flap at the center. For foot catching, he uses the *Bellen Dancer* in calm or the *Bellen Wind Dancer* in wind. See a description of Michael's winning competition booms below.

In the *Accuracy* event, **Casey Larrance** took top honors in Placing, Median and Overall. Casey's equipment will hopefully be described in the next issue of MHR. **Dennis Joyce** had the best Accuracy score with 48 points. This tied the US Record set by **Paul David**. Dennis used a special slotted Outback Tri-blader made by **Doug DuFresne**. Dennis made further alterations that included adding scotch tape to the underside of one entire slot and to half of a second slot. The third slot was uncovered. In higher winds, Dennis adds a US 25¢ coin to the bottom center. You can acquire one of these special tri-bladers (pictured upper right) directly

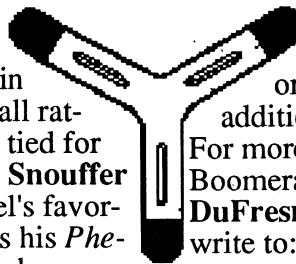

from *Outback Boomerangs* for \$16 unslotted or \$25 slotted. There are additional charges for shipping. For more information on Outback Boomerang products, call **Doug DuFresne** at (503)-292-4316 or write to:

Doug DuFresne
4235 S.W. Crestwood Dr.
Portland, Or. 97225

Rob Parkins took overall honors in F/C in every category. Rob used a copy of a **Matthieu Weber** F/C tri-blader. His technology will be described in the next issue of MHR.

In the *Australian Round* event, **Michael Girvin** took both overall and best median score. **Betsylew Miale-Gix** had the best individual score with a US Record of 89 points. **Chet Snouffer** had the best placing ranking. Both Betsylew and Michael used the Phenolic Sunshine boomerang depicted below as a *Gel Boomerang* product. Betsy modified her Sunshine by adding a penny to the underside of the lift arm tip with a piece of duct tape. Chet uses his *Seabreeze III* which can be weighted with a coin to extend the range beyond the basic 30 metres. The extreme accuracy of the *Seabreeze*

Michael Girvin's Winning Competition Boomerangs

Phone: (510)-658-2469

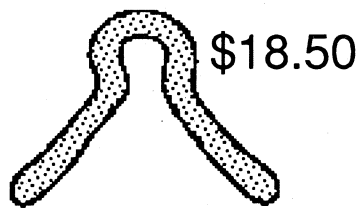

Bellen Dancer

\$18.50

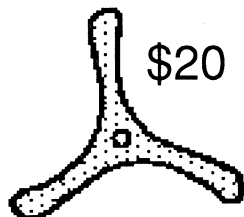

Phenolic Carlotta

\$20



Bellen Wind Dancer

\$21



Phenolic Sunshine

\$27

Gel Boomerangs
2124 Kittredge St. #61
Berkeley, Ca. 94704

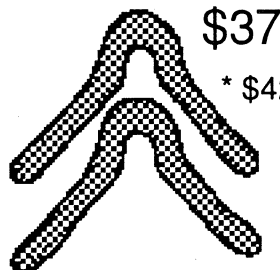

Bellen Jugglers or
 Bellen Teacher Jugglers*

\$37

* \$42

Prices do not include shipping charges. Write or call for a free catalog of boomerang products which include those listed to the left. Ask about the special competition package of 8 boomerangs which is available for the low price of \$125. Separately, these boomerangs would cost over \$150.

III gives the thrower an advantage in accuracy points and good competition placing. The Seabreeze III also comes in a phenolic material for \$20. A complete listing of Leading Edge products can be obtained by calling Chet at (614)-363-8332 or by writing to:

Leading Edge Boomerangs
51 Troy Road
Delaware, Oh. 43015

Ask about Chet's special package of 7 competition 'rangs for \$105. These booms would cost \$125 at regular prices. What a wonderful way to stock a competition kit.

In *MTA100*, Will Gix led the pack in every category except for placing average. Bob Foresi had top honors in that category. Will used a Midi-MTA made by Ted Bailey. Bob used a Maxi-MTA, also made by Ted Bailey. Both models were made out of 3mm birch plywood. The Midi-MTA is priced at \$16 and the Maxi-MTA is priced at \$20. Limited quantities of either model will be available in the Spring. These boomerangs come in a variety of shapes, but the boomerangs used by both Will and Bob have the shape depicted below.

Call Ted at (313)-971-2970 or write to the address below to obtain a listing of Bailey MTA products.

Ted Bailey
P. O. Box 6076
Ann Arbor, Mi. 48108

Chet Snouffer took top honors in all categories of the *Doubling* event. Rob Parkins tied with Chet in the median score. Chet uses his *LE Tri-blader Doublers*, depicted above.



Leading Edge Winning Boomerangs

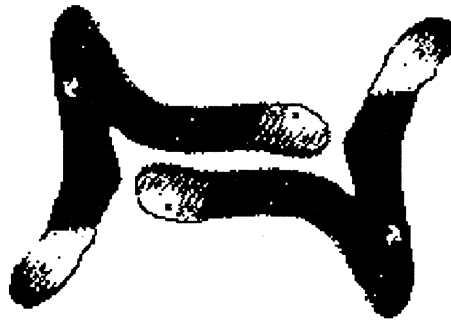

Pterodactyl Jugglers
Pseudo Tri-blader pair - \$35

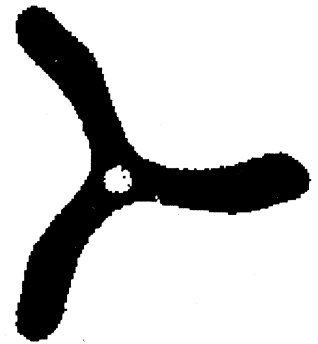

SE-3 Fast Catch - \$20
Comes in two styles:
"hot" & "safe"

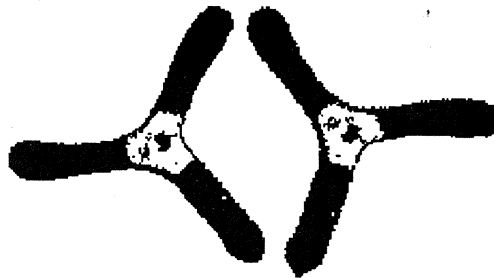

LE Doublers - \$35/set



Seabreeze III (\$15/\$20)
(for Aussie Round)

Chet Snouffer placed number one overall in the *Endurance* event using the (Something Else) SE-3 tri-blader depicted above. Chet also had top placing average for that event. Rob Parkins had the best median score and John Flynn had the best individual score with a marvelous 74. John

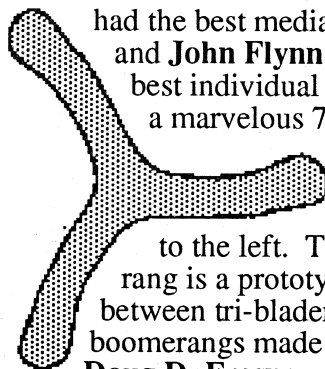

used a tri-blader as depicted to the left. The boomerang is a prototype cross between tri-blader F/C boomerangs made by

Doug DuFresne and Chet Snouffer. John will not market boomerangs that are so close in design to that of other manufacturers.

The readers are invited to buy F/C tri-bladers from Chet and Doug and experiment with their own hybrid designs for personal use.

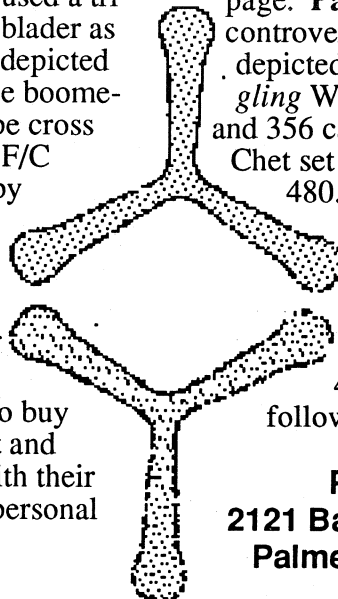

Chet Snouffer took overall honors in the *Juggling* event. He also had best score with a World Record of 480 catches. Paul David took best median score and Michael Girvin took best placing average. Chet uses his *Pterodactyl Jugglers* depicted above. Michael Girvin uses his *Bellen Jugglers* described on the preceding page. Paul David uses his controversial 3mm tri-bladers depicted below. Paul set *Juggling* World Records of 239 and 356 catches in 1992 before Chet set the current record of 480. Paul doesn't normally make these for sale, but he will by special order. Interested parties can call Paul at (215)-826-4337 or write to the following address:

Paul David
2121 Balsam Way Rt. 2
Palmerton, Pa. 18071

BITS & PIECES

News From The USA

John Derden writes to let MHR know that *Jockey International Corporation*, sponsor of the Annual Spring Fling, will place a '92 tournament T-shirt in a time capsule at their corporate headquarters in Kenosha, Wisconsin.

Some of the readers may remember the mention (in MHR #53) of boomerangs in the *Where in the World is Carmen SanDiego* television show. Dean Kelly follows up with word that his wife, Becky, was playing a PC computer game, with the same name, and was given the clue: "Suspect seen returning to a boomerang tournament in Woolongong".

Steve Conaway sent in a copy of a new Disney publication (ISBN:156326-209-6) titled "Why Do Boomerangs Come Back?". The book caters to a child's audience. If you make a trip to Disney Land or Disney World, be sure to pick one up for your kids. You can also order one by calling (515)-284-6730 or by writing to the following address:

Disney Books by Mail, Inc.
P. O. Box 11026
Des Moines, Ia. 50336-6730

T. W. Smith (pictured to the right) is back in business with 3 new catalogs for the entry level, art, and competition markets. His latest research has been focused on scaled down replicas of previous models, such as the *Skillmaker* omega and the *Viola! Micro* boomerangs, both depicted above.

The omega, made out of 4 mm birch plywood, has a span of 11.7", and weighs just 1 ounce. The mini standard is made out of 3 mm wood. It has a span of 10.5", and a weight of 1/2 oz. Both have better range than most comparable products and fly accu-

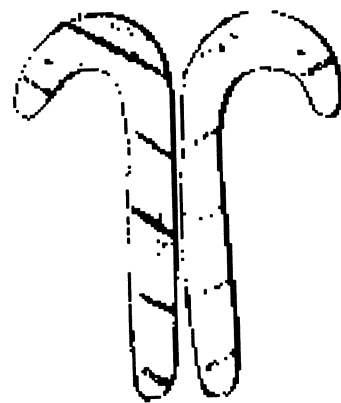
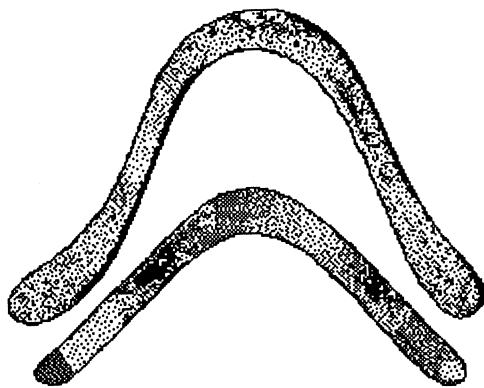

rate low circular orbits. T.W. also invented a novel two piece boomerang called *Candy 'n Caen* (pictured at upper right) which can be used as Christmas tree decorations or tied together in several ways to make a returnable boomerang.

For more information on T.W.'s line of boomerang products, call (503)-942-3167 or write to:

T. W. Smith
P. O. Box 11332
Eugene, Or. 97440

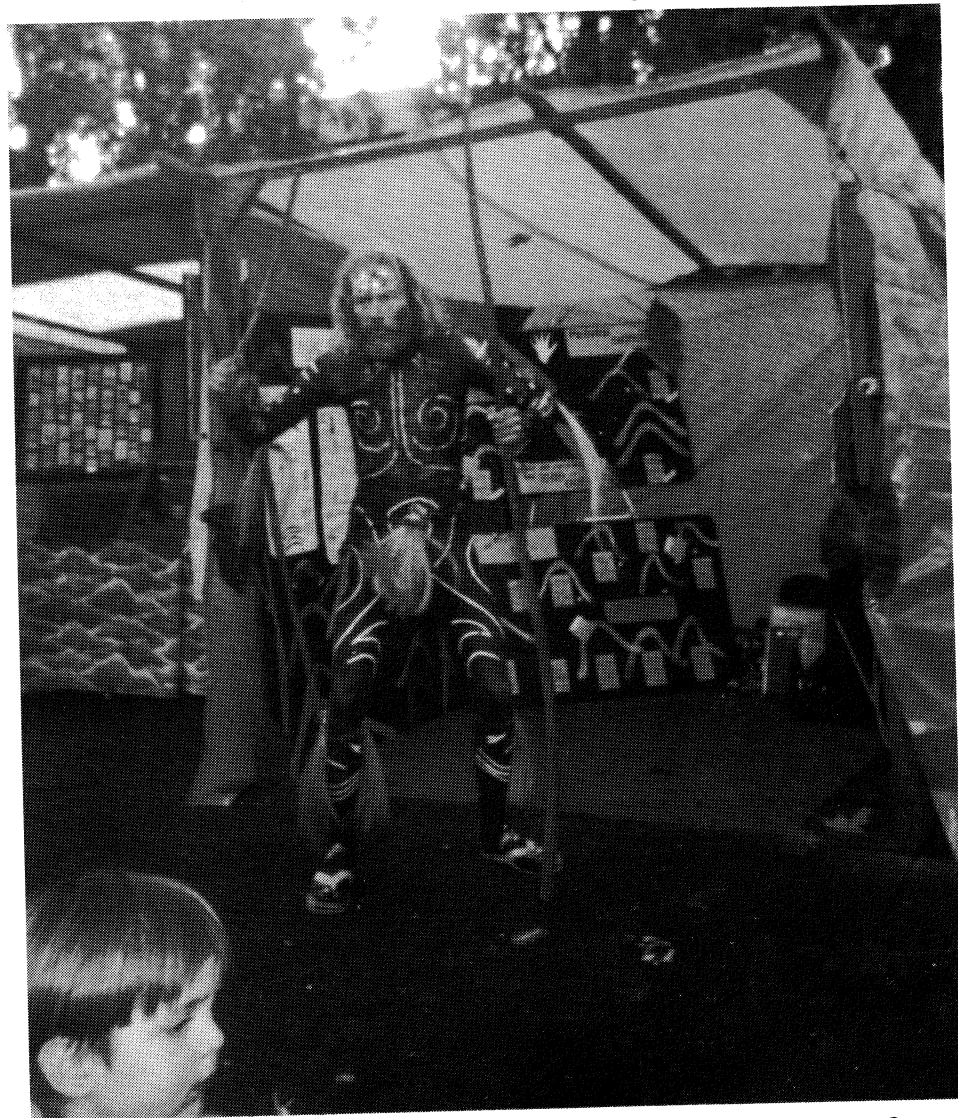

Would You Buy A Used Boomerang From This Man?

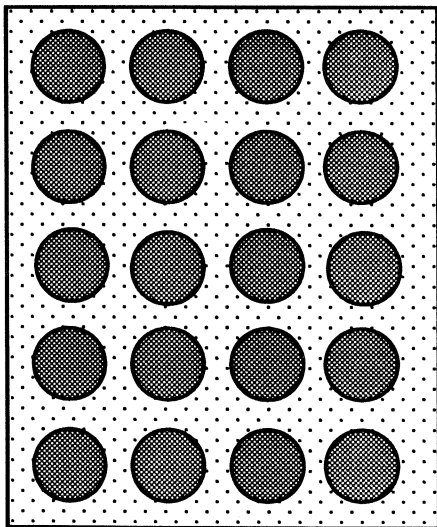

Shercon, Inc. is a company that specializes in supplying tape, tubing, plugs, and other subcomponents for various industrial products. The editor received a copy of their product catalog and discovered a few items that almost every boomerang thrower can use in their throw kit. The first item that caught the editor's eye was a selection of lead tape discs on rolls of paper (depicted above). These precut circular sections of lead tape come in diameters from 0.125" to 2.000" and are in rolls of 200 to 2000 discs per pack. This is an excellent way to add a precise amount of weight to your boomerang without putting a coin under duct tape. If you want to use traditional lead tape on your boomerangs, they carry that as well in widths of 0.5" to 2.0". For more information on Shercon products, call (213)-224-1777 or write to the address that follows:

Shercon, Inc.
1823 San Fernando Road
Los Angeles, Ca. 90065

Ben Ruhe sent MHR a copy of the first issue of "Kites; An Occasional Newsletter", which was produced by Ali Fujino for the World Kite Museum in Long Beach, Wa. The newsletter mentioned that Elmer Wharton and Ben Ruhe teamed to make a "Kite-o-rang"

that doubles as a returnable cross stick and a kite when a string and tail are added. The kite now resides in a special collection that Ben is assembling for the Smithsonian. Ben also sent in the photo (below) of Gregg Snouffer & Fridolin Frost, taken at the 1992 Hampton Tournament. Following the photograph, Fridolin completed 353 consecutive catches in Juggling to win that event.

Michael Girvin writes to tell MHR readers that there has been an explosion of new throwers in the SF Bay Area. Michael has been holding regular boomerang throwing classes at the Billy Martin Field where he teaches the basics of how to throw, tune, and compete. Throwing groups have usually averaged 10-15 throwers, but in the past several months, the participants have been bringing so many friends, that 30-40 throwers have been the rule for 1993. Look for increased competitiveness by Bay Area throwers at future tournaments.

MHR readers were introduced

to *The Australian Catalogue* in MHR #52. This catalog is a great source for Aussie products, such as audiotapes and food products. A listing of other sources for Australian products is added to each order. The editor received the listing recently and discovered more than a hundred new sources for Aussie products, businesses, and clubs. Even the USBA was listed as a source for boomerang information. You can order a copy of *The Australian Catalogue* by calling Pam Wood at (919)-878-8266 or by writing to:

The Australian Catalogue Co.
7412 Wingfoot Dr.
Raleigh, NC 27615

One of the Aussie product sources listed by the Australian Catalog Co. is the *Kangaroo Connection*. This mail order shop, located in Chicago, has a fairly large selection of Aussie goods with a boomerang theme, including pins, key chains & fabrics. They also



Gregg Snouffer & Fridolin Frost at '92 Newport News Comps

sale to serious art collectors. Interested parties can call Barnaby at (212)-643-9139 or write to:

Barnaby Ruhe, PhD
448 W 37th St. (7C)
New York, NY 10018

Readers continue to send in boomerang cartoons to share with the readers. The two cartoons illustrated to the left were submitted by **The Boomerang Man**.

News From Australia

Brother Brian Thomas also sent in cartoons (see p.17) as well as a clipping from an Australian newspaper that showed the **Dalai Lama of Tibet** receiving a boomerang from **Brett Everett** who is a student at the *Gynea Technology High School*.

Brother Brian M. Thomas sent MHR the results of the *Blue Mountain Boomerang Championships* held on 15 November, 1992 in Mulgoa. **Adam Carroll** took first place in F/C with 27.46 sec. **Kevin Moran** took a first in consecutive one-hand catches with 15. **Ray Freebody** won Aussie Round with 50 points. **Brother Brian Thomas** took first in Accuracy with 43. **Günter Wandtke** took first place in MTA with 42.03 seconds. There was no mention as to who won overall. Brian also suggested that we use Bulgarian art from *Forum Avio* on the cover for this issue.

In the last issue of MHR, it was mentioned that eight Janetzki boomerangs were being offered for sale to raise money for an Aussie vision care charity. All boomerangs were priced between \$140 and \$250. All were sold within a week of the first newsletter mailing and several late inquiries went without. Brian reluctantly agreed to supply four additional Janetzki's to satisfy a few more collectors. The editor congratulates those who were able to procure one for their collection. It's



FRANK AND ERNEST by Thaves

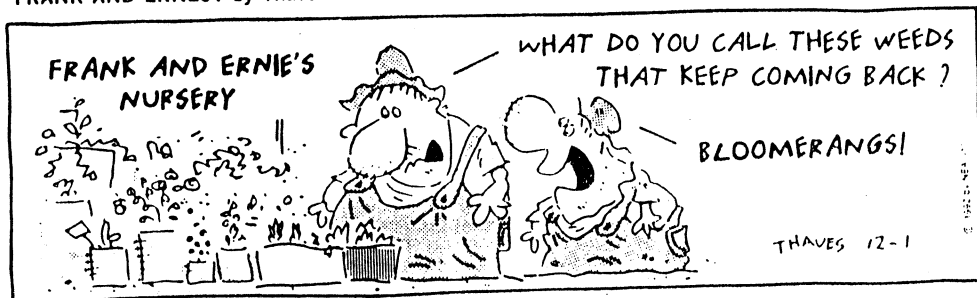

carry a selection of Aussie boomerangs which include *Rang* and *Binghi* returning models. Available Aboriginal artifacts include: Woomeras, Didjeridoos, Clap Sticks, Bull Roarers, and Boomerangs. For information on this source of Aussie goodies, call **Kathy Schubert** at (312)-248-5499 or write to the following address:

Kangaroo Connection
1113 West Webster
Chicago, Il. 60614

Dr. Barnaby Ruhe writes to tell MHR that he will be a married man as of 21 March. Barnaby has a few very old boomerangs/throw sticks for sale. These boomerangs came from the *Holt Museum Collection* that was liquidated during Barnaby's last trip Down Under. He also has a marvelous 30" X 42" bark painting (see left) of *The Rainbow Serpent*. This bark is for

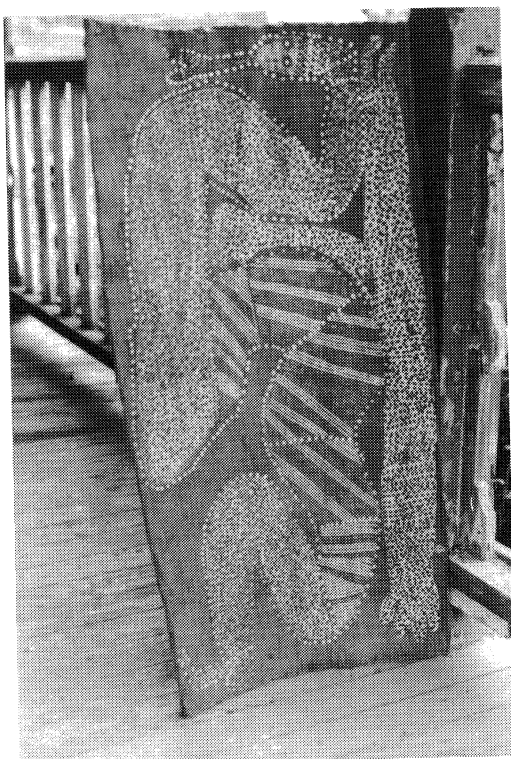

Rainbow Serpent Bark Painting

SNAKE

Tales by

SOLS



★ "Looks like suicide, Inspector."



The Dalai Lama of Tibet With His Returning Boomerang

nice to know that Janetzki boomerangs continue to hold their investment value in these sad economic times. Late word arrived that **Dr. Fred Hollows**, who headed the vision care charity, passed away from Cancer on 10 February. Brian was a member of the guard of honor at his funeral which was made an official state funeral by the Prime Minister of Australia.

Brother Brian Thomas and **Tony Butz** have made up some boomerang slogans on adhesive labels which can be used to decorate boomerangs, envelopes, etc. Sticker messages include: "Dead Trees Live On As Boomerangs"; "Boomerang Throwing, The Space Age Sport Older Than The Pyramids"; "On The Third Day God

Left Turn Boomerangs



Recreational and competition models from \$8 to \$18. Made from 10 ply, 5mm birch. Stained (not painted) to preserve natural wood grain. FREE CATALOG. Norm Kern, 1640 Haynes Birmingham, MI 48009

Created Trees . . . For Boomerangs!"; and " Boomerangs . . . One Thing Edison Didn't Invent". These stickers are for sale at a low cost. Interested parties can contact Brian for more information at the following address:

**Brother Brian Thomas
Waverly College
131 Birrell Street
Waverly, N.S.W. 2024
Australia**

News From Bulgaria

Georgi Dimantchev sent MHR a selection of newspaper and magazine materials. The articles, written in Russian, show a strong effort by Georgi and his club in promoting the sport in Bulgaria. One of the articles showed a photograph (depicted bottom left) of Georgi with an Aboriginal shield and throwstick from the Bulgarian Ethnographic Museum. The artwork from another article graces the cover of this issue of MHR.

One publication, "Club M" was very similar to that of the American "Playboy" magazine. Georgi is working on a research project that classifies boomerangs by type. Look for more on this in a future issue of MHR.

Another research project includes experimentation with MTA shapes and materials. One of the more promising designs (Butterfly) is depicted above right.

The material has advantages over Paxolin/Pertinex in that it's metal laminae allow the material to be bent into a desired tune, yet it has the strength and density of the composites used in Western Europe. Georgi has developed a lightweight low cost 4 bladed boomerang called the "Good Boy".

He is seeking retailers who are willing to carry this product. Revenues will be used to subsidize future overseas boomerang competitions for he and his team. Parties interested in making contact with Georgi and the Bulgarian Boomerang Club can write to the following address:

**Georgi D. Dimantchev
Hipodruma 139A-A-23
1612 Sofia
Bulgaria**

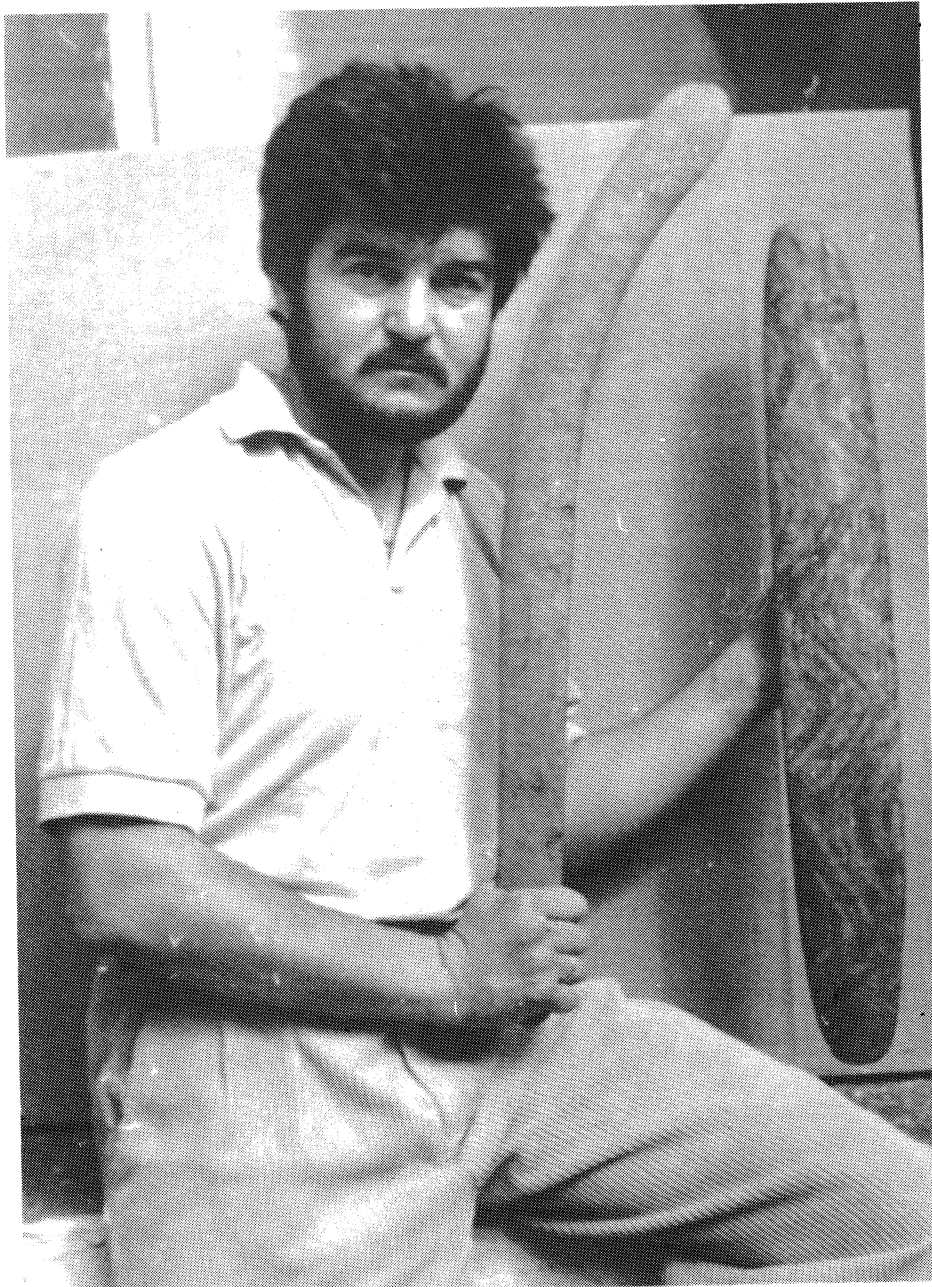

Georgi Dimantchev and Aboriginal Artifacts

DISTANCE

Montreal Boomerang Club Bulletin du Club de Boomerang de Montreal
CANADA

N° 4 WINTER-HIVER 1993



News From Canada

Many of the readers are unaware that Canada has a newsletter like MHR. "Distance" (see above) is published by **Stephane Marguerite** and the *Montreal Boomerang Club*. Articles are written in a mixture of French and English. The price is a bargain at only \$10 for 4 issues. Interested parties can write directly to:

Club de Boomerang de Montreal
C. P. 1000 Succ. M
Montreal (QC) H1V 3R2
Canada

The Royal Boomerangs, shown on the cover of MHR #53, have finally been delivered to **Prince Charles** in Merry England. The February 1 edition of *The Windsor Star* mentioned that the boomerangs were to be delivered to their new home on February 5 by **Richard Baron** of Chatham, Ontario. The extensive article, titled "Return to Sender", was full of interesting tidbits about **John Cryderman**, the Royal Boomerangs, and boomerangs in general. Shortly after the delivery, John received a registered letter from **Prince Charles** thanking him for the wonderful gift.

The Chatham Wood Show is still scheduled for April 23-25.

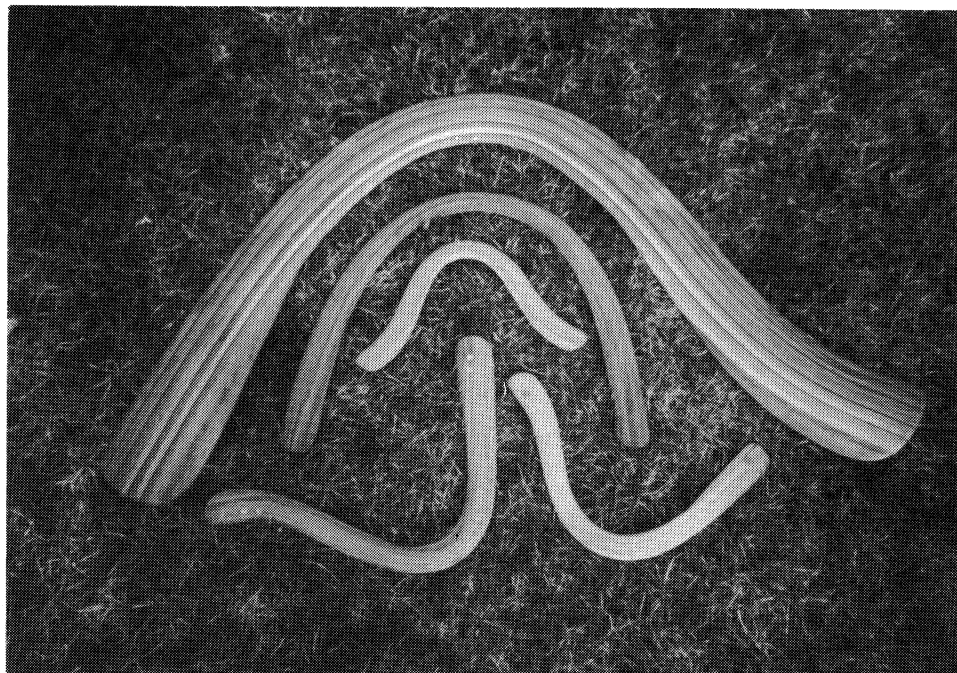

Giant Gerhards Style Hook With Other Cryderman Products

The International Boomerang Design Contest will be held on the afternoon of April 24. Several beautiful entries have already begun to arrive.

John Cryderman wishes to remind MHR readers that there is still time to purchase raffle tickets for the \$2,500 boomerang described in the last issue of MHR. Tickets can be ordered directly from USBA headquarters at a price of \$3 each; 2/\$5; or 10/\$20. The drawing will be held on April 24. Raffle tickets should be purchased prior to April 15 to allow adequate time for transferral of ticket stubs from USBA to Chatham. The winning party will be responsible for shipping charges.

The giant Gerhards Hook that was described in MHR #53 is being offered for auction. Auction proceeds will go directly to fund

the 1994 World Competition in Japan. Interested parties can bid on this marvelous collectable by sending three bids: high, medium & low directly to **John Cryderman** at the address that follows. Your lowest bid that exceeds the highest bid by anyone else will be the winner. Bids must be received by May 1. The winning party will also be responsible for shipping charges. The giant hook is also shown above with other S/L Gerhards style boomerangs that are being offered for sale. Call (519)-351-8344 for more info or write to the following address:

John Cryderman
136 Thames St.
Chatham, Ontario
Canada N7L 2Y8



THE BOOMERANG MAN

"Giving fast, personal service since 1975!"
RICH HARRISON'S ANNUAL CATALOG

1993 CATALOG FREE!!!

1806 North 3rd St., RM → Monroe, LA 71201; (318) 325-8157

KAK

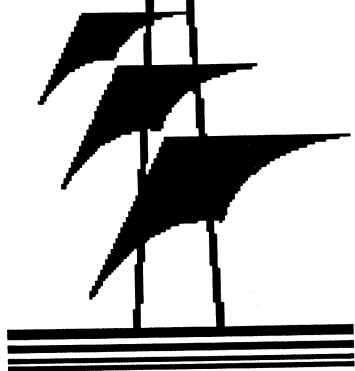

KAPITOL AIR KORPS

A kiteflier's club in the Washington, DC area; For more info, call: (703)-765-5668 or write to:

KAK
P. O. Box 7254
Silver Springs, Md. 20907

News From England

Ben Ruhe notified MHR that *The South Bank Centre* in London is planning a major festival of Australian Aboriginal Art for this summer. An exhibition of boomerangs will be held in the Foyer Exhibition space with, hopefully, boomerangs from the South Aus-



For the very best quality Finnish Birch Plywood with a 5% USBA discount:

Anderson Int'l Trading
1011 West Barkley Ave.
Orange, Ca. 92668

(800)-454-6270
(714)-771-6270

tralia Museum in Adelaide. For more information on this event, call **Ben Ruhe** (in the USA) at (202)-234-9208; or contact **Theresa Bergne** at 071-921-0600 in London; or write to:

The South Bank Centre
Royal Festival Hall
London SE1 8XX
United Kingdom

News From Fiji

Sam Lemay has been living in Fiji for the past 7 months and is doing all he can to spread the word about boomerangs. He is even making and selling booms to the locals. Sam recently sent in several submissions to MHR. The first was an article out of the 3 November issue of *The Fiji Times* called "Boomerang Fever Comes To Labasa".

This article featured two nice shots of Sam, his uncle, and his favorite boomerangs. The second submission was out of an unnamed Australian magazine with a small blip about **Bryce Maskey**, who makes bird shaped boomerangs Down Under. The third article was an excellent writeup on boomerangs from the February 1, 1992 edition of "Good Weekend" magazine. The article "Good Returns" featured seven great pictures of boomerangs from Australia and lesser known sources such as: India, North America, Africa, and Vanuatu. This is one of the few Aussie publications that candidly admits that the origin of the boomerang is not exclusively Australian. With significant reference to the South Australia Museum exhibit, the article is well worth reading.

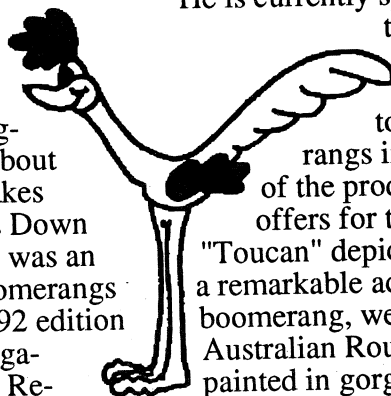
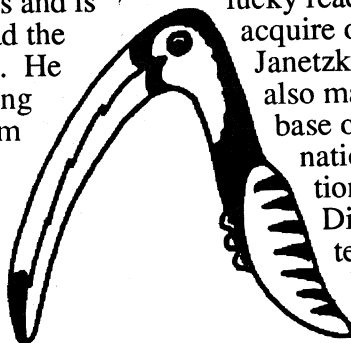

News From France
Olivier Vouktchevitch writes to inform MHR that the *Tarn Boomerang Club* has become the *Toulouse Boomerang Club*. For further information about this club, contact the following address:

Francois Cochet
32 rue Alain Savary
31270 Cugnaux
France

Didier Bonin was one of the lucky readers who was able to acquire one of the collectable Janetzki boomerangs. Didier also maintains the best data base of National and International records, mentioned in MHR #53.

Didier is especially interested in adding collectable boomerangs made out of exotic woods or animal shapes to his personal collection. He is currently spending the Winter as a Ski instructor in the Alps before returning to making boomerangs in the Spring. One of the products that Didier offers for trade or sale is the "Toucan" depicted above. This is a remarkable accurate 55 m boomerang, well suited for the Australian Round event. It is painted in gorgeous air-brush colors. Didier also makes the "Road Runner" tri-blader illustrated to the left. The "Coyote" model will follow shortly. Parties interested in acquiring some of Didier's fine art boomerangs, by purchase or trade, can contact him at the following address:

Didier Bonin
Boomerang Club Dijon
15, rue Vannerie
21000 Dijon
France

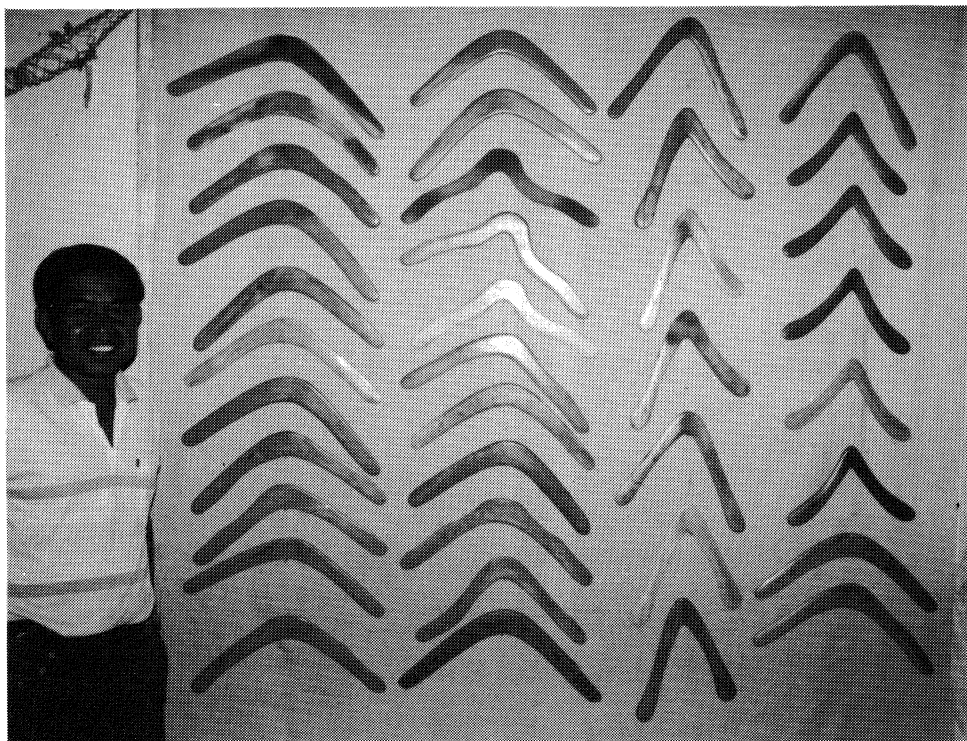

Erwin P. Brojan and His Natural Elbow Boomerangs

News From Poland

Janusz Jacek writes to let MHR know that he has recently married a lovely girl named **Zosia**. We certainly hope that his new family status does not put a dent in his boomerang throwing activities. Congratulations to the new couple.

News From Philippines

Erwin P. Brojan writes to let the readers know that he can be an excellent and inexpensive source for beautiful tropical hardwoods, such as: *Avacado, Malobagro, Jackfruit, Mango and Guava*. Many of these species are rarely offered for sale in the USA and have beautiful grain patterns.

Erwin's boomerang activities have been recently suspended because of the volcanic activity that has caused an emergency situation in his community. He is still able to receive correspondence at his regular address. For more information on Erwin's Philippine hard-

wood products, write directly to the following address:

**Erwin P. Brojan
Guinobatan Post Office
Guinobatan, Albay 4503
Philippines**

News From Switzerland

Kim Galeazzi writes to inform USBA that he has moved to California in the recent past. **Manfred Stahle** steps down as international correspondent for the Swiss Boomerang Club. **Thomas Stehrenberger** (tel: 052-286204) takes his place. All international correspondence to the club should be addressed to:

**Thomas Stehrenberger
Tösstalstraße 249
8405 Winterthur
Switzerland**

HOT STUFF

**100% Cotton
Heavy weight
T-Shirts**

Style A - Magic in motion



* front **\$15** back

Style B - Glim on Boomerang



* front only **\$12**

Style C - Insomniac Theatre

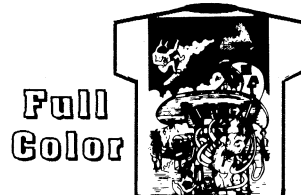

* front only **\$15**

*Available in adult sizes- specify sm-md-lg-xl
For xxl add \$2

**NEW PROJECT 6
Boomerang**

\$22 5 ply finnish birch/classic V shape
designed & crafted by Mike "Gel" Girvin

**Also PROJECT 6
"Guitar Corral"
Cassette**

includes the song
"Boomerang" 4 songs \$4

all prices include shipping
add \$4.00 for C.O.D.
please allow 2-5 wks. for delivery
California residents add 8.25% sales tax

Send your order to:
**Offshore
Screen Printing
1830 B. Palmetto Ave.
Pacifica, CA 94044**

Of Boomerangs and Circular Arguments

by D.L. Haire (an avid recreational boomeranger from North Hatley, Quebec)

*As I embark upon this doggerel of rhyme
It's doubtless 'rangs have been around - For a very long time...
Aborigines surely harnessed the power - Of their whimsical flight...
Small game were no match - For the whirling stick's bite.
Yet as legends tempt me - To believe what I might...
This latest rumour seems a trifle lax...
Could Icarus have really tossed - A boomerang of wax?
And though one may argue ad infinitum - The boomerang's universal appeal
Folks North/South/East and West - Cannot hide their zeal.
Culture/politics/race - even gender
Should pose no real barriers
'Cause 'rangs fly as grandly - In the air as avian harriers
When propelled from anyone's arm - With touch of magic!
They return to the sender
Like an ill-posted letter
But oh so less tragic!
In fact so much the better!!
And although a boomerang's precession
Won't curb the current recession.
It may open up avenues - For artistic and athletic expression
To allay inter alia - Sedentary depression?
As a passing fascination - Or beloved obsession!
Hearty birds of a different feather
Undeterred by the most inclement weather
With ardour to the 'rangfields they go
In the rain, the sleet, and the snow!
To throw, and throw, and throw...
With apocryphal or real circus-catches
In imaginary or actual-life matches
Oblivious to everything...even sound?
While trying to master the Aussie Round!
Diving outward for 'rangs they bound
Often becoming intimate with the ground!
...Rang still elusive to the hand...
Through the fingers- as grains of sand
In the baseball vernacular - With this attempt the boomeranger 'fanned'!
Intercepting a 'rang's aerial navigation
Though short of a cosmic revelation
Each time's a small victory of sorts...
For an aficionado courts
Every 'rangs unique eccentric tone...
With arcane adjustments- a twilight zone
Harrumph...harrumph - And as this desultory harangue
Now adjourns...
I wish each and every boomerang
...And boomeranger- Many Happy Returns!*

SUPER CATCH HONOR ROLL

Ted Bailey (6)
Volker Behrens
Gerhard Bertling
Didier Bonin
Rob Croll (7)
Eric Darnell
Doug DuFresne
John Flynn
Torsten Fredrich
Fridolin Frost (8)
Mike Forrester
Kim Galeazzi
Matthias Giesenschlag
Michael Girvin
Rob Greer
Thomas Hartmann
Axel Heckner
Dennis Joyce
John Koehler
Uli Konzelmann (8)
Jeff LaCount
Mike LaPrade
Ray Laurent
Gerrit Lemkau
Alain Mangin
Mole Man
Gunter Moller
Rob Parkins (8)
Roger Perry (6)
Philippe Picgirard
Jonas Romblad
Barnaby Ruhe
Larry Ruhf
Tim Schallberger (8)
Chet Snouffer
Gregg Snouffer (7)
Olivier Vouktchevitch
Matthieu Weber (8)

{ (#): No. of fast catches if more than 5 }

For the benefit of those who are unfamiliar with the term Super Catch, the thrower must launch a MTA from the center circle, then complete a round of Fast Catch from the same circle. The thrower must then catch his MTA. The thrower has the option to throw & catch more than 5 times within the F/C sequence.

USBA INFORMATION PAGE

Many Happy Returns

Circulation: 500 Worldwide.

Published by the:

U. S. Boomerang Association
P.O. Box 182
Delaware, Ohio 43015

Mechanical Measurements:
Image area: 9.5" deep by 7.5" wide; 3 columns to a page; width of a single column: 2.25"

Advertising Rates:

Full Page	\$200
2 Columns	\$150
1/2 Page	\$115
1 Column	\$80
Per Column inch	\$10

10% discount for 4 consecutive issues. All advertisements must be pre-paid in USD by check or M. O. to U.S.B.A. Camera-ready copy preferred. The editor reserves the right to refuse any advertisement or cancel a contract without reason. The deadline for all advertisements is March 1, June 1, September 1 and December 1 for the Spring, Summer, Fall and Winter issues respectively. Newsletter submittal priority is based on submission date and content. Please notify the editor of upcoming tournament dates as soon as possible. A copy of the tournament results, with commentary, should be submitted as soon as the tournament is completed. Questions regarding newsletter submittals can be directed to **Ted Bailey** at (313)-971-2970. All newsletter submittals, including advertisements, should be mailed without delay to the following address:

Ted Bailey
P. O. Box 6076
Ann Arbor, Mi. 48106-6076

Questions regarding *newsletter delivery status* should be directed to Publishing Director **Jay Emerson** by calling (313)-347-3864 or by writing to the following address:

Jay Emerson
1415 Nardeer
Novi, Mi. 48374

USBA INFORMATION

The USBA provides information listings to members at a nominal charge. A listing of boomerang manufacturers; a listing of wood sources; and a listing of boomerang clubs can be obtained by sending a SASE. Allow one ounce postage per listing. A sampling of vendor catalogs or a USBA rule book costs \$2 and a self addressed envelope (no stamps). Send all inquiries to:

USBA
P.O. Box 182
Delaware, Ohio 43015

Chet Snouffer will respond quickly to special inquiries that are mailed to: Chet Snouffer; 51 Troy Rd.; Delaware, Oh 43015. In the event of an emergency, you can contact Chet at (614)-363-8332 (9 -12 AM EST).

USBA BOARD OF DIRECTORS

President

Jim Jordan
11813 Silent Valley Rd.
Gaithersburg, Md. 20878
Ph: (301)-424-4562

Vice-President

Chet Snouffer
51 Troy Road
Delaware, Ohio 43015
Ph: (614)-363-8332

Treasurer

John Flynn
52 Christian St.
White River Junction, Vt. 05001
Ph: (802)-296-2158

Secretary

Gregg Snouffer
340 Troy Road
Delaware, Ohio 43015
Ph: (614)-363-4414

Directors

John (Mole Man) Anthony
Ph: (203)-924-6735

Michael Girvin
Ph: (510)-658-2469

Betsylew Miale-Gix
Ph: (206)-485-1672

Jim Schramm
Ph: (314)-993-9215

Mark Weary
Ph: (602)-759-3973

USBA MEMBERSHIP INFORMATION

All membership dues should be paid by check or money order in \$USD\$. Make checks payable to: U.S.B.A. Domestic and Canadian annual membership dues are \$10 per year. A domestic lifetime membership is \$150. Annual overseas dues are \$20. A lifetime overseas membership is \$250. Check your newsletter label for expiration issue. Mail all checks or money orders to the address below:

U. S. Boomerang Association
P.O. Box 182
Delaware, Ohio 43015

Membership status questions should be directed to **Gregg Snouffer** by calling (614)-363-4414 or by writing to the above USBA address.

New Member Application

Instructions: USBA member should copy this page and fill in his/her name as sponsor. Carry extra copies of this sheet in your boomerang bag and hand them out to potential new members.

name

address

address

city/state/zip or country

phone number (optional)

USBA member sponsor's name

New member: Please read USBA Membership Information above. Send the completed coupon and (\$10) check or M. O. to:

USBA
P. O. Box 182
Delaware, Ohio 43015



PRINTED MATTER

**UNITED STATES BOOMERANG ASSOCIATION
P.O. Box 182
Delaware, Ohio 43015
U.S.A.**

Last Issue: #57, Winter 1994
Date W. Riendeau
P.O. Box 484
Jackson, CA 95642

