

# Many Happy Returns

Issue No. 59

An International Publication of the United States Boomerang Association

Summer 1994



## THE ST. LOUIS SUMMIT



## ★ PRESIDENT'S COLUMN ★

### *What's In This Issue!*

| Page | Contents             |
|------|----------------------|
| 2    | President's Column   |
| 3    | USBA Store           |
| 4    | Left Turn Boomerangs |
| 6    | Q&A Column           |
| 7    | Tournament Reports   |
| 9    | Boomerang Season     |
| 10   | USBA Nationals       |
| 12   | Bits & Pieces        |
| 14   | Toss Across America  |
| 15   | Election Ballot      |
| 16   | Design Solutions     |
| 18   | Thrower Profiles     |
| 19   | Info Page            |

Greeting once again one and all. To dispense with the formal business first, please take the time to read the bylaws which are included as an insert in this issue. By unanimous vote, the Board of Directors has recommended that the membership vote to accept the proposed additions and deletions set forth in those bylaws. The materials which are being added are underlined. If you will not be able to attend the membership meeting at the Nationals in Jackson, MI and wish to vote on whether to accept the bylaw amendments, you will need to do so by mail. Please put on a piece of paper your vote to accept or reject each change. List them separately by article and section. Sign your name at the bottom of the page and return it to the USBA, PO 182, Delaware, OH 43015 along with your ballot for the officers and directors. Only those who have not voted by mail will be allowed to vote at the national champi-

onships itself for both the proposed by-law amendments and the officers and directors.

One of the primary concerns over the the last couple of years has been the diminishing membership numbers. I am pleased to report that we have made progress in increasing membership over the last few months. In order to further our long-term growth prospects, I believe our primary emphasis must be to appeal to kids and young adults. We also need to make boomerangs which work readily accessible to them at a reasonable cost. In general, we must create an atmosphere across the in which boomerang throwing is an accepted sporting activity that people will stick with.

Some of you are already working with scouting organizations, community recreation organizations, and park departments in your own communities providing not only an introduction to the sport but a structure through which people can continue to participate. One of the ideas that the membership committee adopted was my proposal to put together a curriculum for submission to school districts for incorporation of a boomerang unit in existing craft, physical education, or historical programs targeting grades 5-9. This program would incorporate an educational component with the history and development of boomerangs as a tool, recreational pastime and sport, as well as provide for instruction in basic boomerang games, safety, and throwing. Hopefully, this will be one of the projects worked on by the Board you elect for next year. Once we put together such a program it will be available through the USBA PO Box.

It is the responsibility of all of us to sell it to our neighborhood schools. It was suggested to me in recent contacts with the Edmonds School District Athletic Director that, instead of going to the School Board itself, it would be more useful to attempt to make contacts with the P.E. or History teachers and principles of individual schools to get the initial entry. He will be assisting Will and I, for example, in creating a workshop unit for the local alternative school which has students both of grammar school and middle school age. It is our intention to incorporate all of the above features into that workshop to the extent that we will be al-

lowed time to do so. If the project is successful, you will be hearing about it later!

While we need to nurture all aspects of our interests we must not forget that it is the participatory, usually competitive events which will inspire the kids to continue throwing and give them reason to advance their skills. I am sure all of you have experience with teenagers, young adults, and not so young adults who have come out, seen you throwing, tried themselves, and then lost interest after a few outings. Like it or not, the key to increasing membership in most recreational activities has been the development of competitive games that give people the incentive to increase their skills and add additional equipment.

I encourage all of you to put into effect some of the events and activities that you read about in Issue 58 of MHR. In addition, the USBA has adopted a set of event rules to assist you in holding beginner or "Super Novice" competitions which are specially designed for keeping the interest and participation of new throwers. Such a fun tournament can be held at nominal expense for the director and can completed in half a day.

In the alternative, commit to being at your field on a specific day and time weekly, or every other week, or even once a month so that those in your community who are interested will have a schedule they can follow to find others to throw boomerangs with. As with any other sport the consistent opportunity to get together with others and have fun playing the game, trying new equipment, and developing skills is necessary for long term involvement in the sport.

All of you reading this are probably thinking, well that is nice, but it sounds like work to me. You are right, it is work. These things must be done by each one of you and by those you bring to boomerang throwing in your communities if we are to prosper.

If you do not know who the other throwers are in your area, you can obtain a printout of the current USBA membership by sending a request for it to the PO Box. Please include a SASE and check in the amount of \$2.00 to cover the cost of printing and mailing.

Betsy Lew Miale-Gix

# The USBA Store

As promised The USBA Store now carries boomerangs. I currently have Outback (Doug DuFresne) and "Gel" (Michael Girvin) booms in stock.

Scorch the earth in Fast Catch with a *FC III* from Outback. Look up Fast in the dictionary and you'll find a picture of this boom! Tuned, Flight tested and Guaranteed by Doug to liven up your day! \$25.00 plus shipping.

Improve your Trick catch scores with a *Carlotta* from Gel Boomerangs! This is the birch version of this famous tri-blader. The *Carlotta* is designed for easy immensely catchable returns. If you have any doubts, talk to someone who owns one! \$15.00 clear finish, \$17.00 decorated plus shipping.

The USBA store is auctioning a Georgi Dimantchev "Topic MTA". The upper surface is .05 c.u. layer profiling a chemical workup by Georgi. The early prototypes have recorded times of 40 seconds in some pretty nasty winds. Please send a "low and High" bid to Dean Kelly in care of the store. The draw date for the boomerang is August 30, 1994, so get those bids in early.

For a complete list of what is currently available in stock, send a SASE (USA) or \$1 (overseas) to:

**The USBA Store  
C/O Dean A. Kelly  
3350 Neef Ave. SE  
Salem, Or. 97302**

Questions? Call: (503)-581-8050

All prices are in \$USA\$ and include Shipping and Handling to the USA or Canada. Overseas orders must include \$2 extra for surface or \$4 extra for Airmail per item. Back issue newsletters are \$1 additional for surface mail and \$2 extra for Airmail.

## USBA Store Stock Availability - Prices Each Item:

- \$1.50 USBA Mylar Decals
- \$6.00 "Boomerang": a book by Ben Ruhe
- \$8.00 "The Big Book About Boomerangs": a book by H. L. Mayhew\*
- \$4.00 "The Boomerang": an early pamphlet by B. Ruhe/L. Hawes
- \$2.00 'Low-Reynold-Number Airfoils article  
*Scientific paper on airfoils*
- \$1.00 List of Boomerang Related Patents
- \$2.00 Newspaper Articles from 1984
- \$20.00 Huerer Swiss Digital Stopwatch\*\*
- \$15.00 USBA T-shirts available in sixes: M, L, XL color: gray
- \$12.00 USBA '93 Open T-shirts available in size M, L, XL. color: gray
- \$2.50 Back Issues of MHR: # 21-W85; #23-Sm86; #26-Sp86;  
#27-Sm86; #28-F86; #29-W87; #31-Sm87; #32-F87; #33-W88  
#52-F92; #53-W93; #57-W94.

\* First edition and signed by the author.

\*\* high quality Swiss made. A \$50 value. Only one left.

## ***BOOMERANG THROWERS' E-MAIL ADDRESSES***

VERSION 2.1 JUNE 1, 1994. Compiled by PDS

Dean Kelly.....INTERNET:Dean.A.KELLY@OEDD.or.gov  
Eric Promislow.....INTERNET:emp@xgml.com  
Jim Sprague.....INTERNET:sprague@engin.umich.edu OR CompuServe 71601,2752  
Mike Roedelbronn.....CompuServe 72722,3053  
David Silver.....CompuServe 72133,3725  
Paul D. Sprague.....CompuServe 72470,1567  
Ralph Bonheim.....CompuServe 72020,1046

Please submit your electronic address to Paul D. Sprague - (earth coordinates: Two Ems, Inc., 782 Boston Post Rd., Madison CT 06443.

## **THE WORLD ACCORDING TO CHET-**

In a Tournament held in the summer of 93', our National Champion bestowed some of the greatest wisdom ever given to one of the new throwers.

**THROWER:** Running frantically to get the aid of his mentor "Chet, I get this Aussie Round Boom to go out fifty meters, but, I can't get it to come back.

**CHET:** Looking intently at the sky watching his own boom, "Hmm, Well, getting the boomerang to come back is...important!"

The crowd erupted in laughter, and so was born the Chet-ism. More to come in future issues!

---

---

## *How I Make Left Turn Boomerangs*

---

---

*By Norm Kern*

The first challenge in making boomerangs is finding suitable plywood. The standard lumber yard variety is just too heavy and has too many voids. It takes just as much time to make a boomerang out of bad wood as with good wood, but unless the wood is of fairly high quality, you just won't get many throws before it breaks. Look for ads in this issue or you may acquire a list of sources for good plywood from the USBA. See the inside of the last page of this issue. If you just can't wait for a mail order to arrive or you want to start with a small quantity, you can try hobby stores which specialize in RC airplanes. Ask for aircraft grade plywood. Secondary possible sources are cabinet makers, and doll house shops. A board with a little bow or bend is fine, but avoid significantly bent pieces. This can have a devastating effect on boomerang flight. If available I use 10 ply 5 mm, or 4 mm. If the measurements are in inches, ask for 3/16, 5/32, or 1/8 inch. 1/8 inch works very well for mini sizes. Just use a photocopier to photo reduce a boomerang or pattern down to 75% size. I have not enjoyed using 1/4 inch. You just have to take too much wood off for the air foils, and you have to throw these heavier boomerangs harder.

The next challenge is to find the tools. I have a Dremel scroll saw. You can use a coping saw or a saber saw. I have only used a saber saw a few times. I find I can not get the precision with it that I get with the scroll saw. Saber saws give rough edges on the blank. Before sawing, check the wood to see which way it naturally bows or bends. Take advantage of this by ensuring that you carve the airfoils on the surface which bows up. This will ensure that you have the

wood naturally adding the dihedral most boomerangs need. To facilitate sawing, I simply trace one of my patterns or an existing boomerang onto the wood. The boomerang should be cut with the grain going straight up and down or straight across. See Diagram 1. This will provide identical tuning ability for both arms. If the boomerang has the grain parallel to one arm and perpendicular to the other, bend or twist tuning will be very difficult. (This is not true for MTAs where it may be beneficial to have one arm more tunable.)

Once the blank is cut, I use a variable speed drill motor with sanding disks to "carve" the air foils. I use two different disks; a stiff one with coarse sand paper for the trailing edges, and a foam padded one with medium sand paper for the leading edges and the elbow. I use a piece of medium sand paper wrapped around a pencil for the inside of the elbow. You can do all of this carving with hand files, rasps, belt sanders, or drum sanders. I have carved several boomerangs with hand files while sitting around camp on vacation. When using belt or drum sanders most makers put the blank upside down and work without seeing how much material is being removed. With a drum sander it is possible to place the blank under the drum but I have used drums and find I am happier with the drill and the sanding disks. Some people find that it is difficult to keep the sanding disk from jumping or skipping. I developed a technique of steadying the drill on the front of my body. You may want to match the height of your body to the height of your work bench to accommodate this.

To carve the boomerang, I lay the blank right on the edge of my work bench and steady the drill on the side of my body. I then move the sanding disks back and forth across the blank until I have removed as much material as I intend. With this technique you can see the surface on which you are working, so you can do this very evenly and quite gradually. You may want to

clamp the blank down, but I just hold it steady with my free hand. This is easiest on the trailing edge of the trailing arm, so I start there. I like to do the trailing edges first. I can do a better job of blending the leading and trailing edges if the trailing edges are there first. After I make the initial passes as described with the blank on the bench, I pick up the blank and use the disk with the medium grit sand paper to round the leading edges further. Using a slow rotational speed keeps me from removing too much material. Having made it as smooth as the power tools allow, I use a medium 3M Flexible Sanding Pad to complete rounding off the leading edges, the tips, and the elbow. These pads are a little expensive but they last for about 12 boomerangs and really make this step a breeze. I always round off these angles, but I do not round off the A/B (see figure) transition on many of my models. More on that below.

Getting started - I suggest that once you have the wood and the tools, you select a boomerang that works well for you and trace it onto the board. Try to carve an airfoil similar to the original. Verify that your copy has about the same dihedral (bend in the wings) and then take the original and your copy out to the field. If the copy does not behave like the original see if you can determine why. It may be a difference in the airfoils or it may be a difference in the dihedral or the angle of attack. On the next one, try radical differences in the airfoils (see below). I am not suggesting or condoning commercial copying of other's designs, but to make boomerangs for your own use, you will learn more quickly if you start with a design with which you are familiar and one that you can compare to a working boomerang. Ted Bailey suggests that you write the name of the originator of the design on your copy. It won't be long before you are totally bored with copying, and you will begin the adventure of experimentation with original designs.

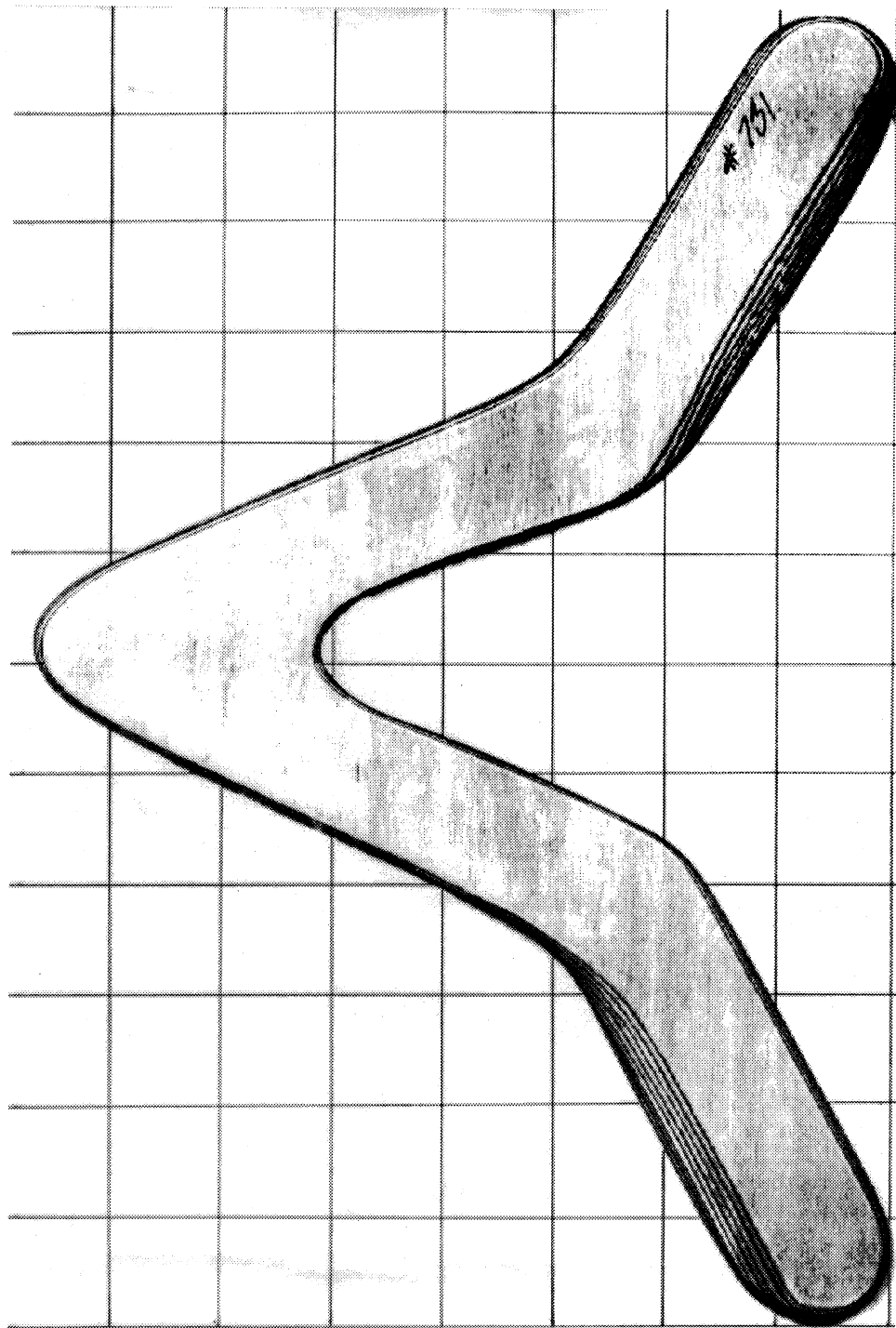

# The USBA

# Q

# &

# A

## Column

...because enquiring minds  
want to throw.  
by Chet Snouffer

Dear USBA,  
Explain why dihedral has the  
influences it has. I know what  
they are, but I want to know  
"why"?

Norm Kern, Michigan

As you may recall, last issue we left Norm hanging. Well, a quick look into the archives found the answer, perhaps, to Norm's query. See if you can follow along.

The following article was written by Gerhard Bertling in the German newsletter, "Boomerang Welt No. II/1988. It was translated by Buzz Woodruff of the British Boomerang Society in BBS Newsletter # 2/88 and subsequently reprinted in "The Leading Edge" Issue #46.

More often than not, you just can't get away without a bit of bending; especially MTA boomerangs. Bending the wings (called adding dihedral, anhedral, or twisting wash-in or washout) is easy to get the hang of. It changes the lift, but also the wind resistance and drag of the changed arm.

Adding dihedral and anhedral makes a level or 2-dimensional body into a 3-dimensional body.

So what happens?

If you lay a strongly bent boomerang on a flat table, the arms will make contact, with the elbow and wingtips up in the air. If you press the elbow, the wingtips will go up, and vice-versa. So what position will the boomerang assume in the air, or to phrase it differently, around which axis will it rotate?

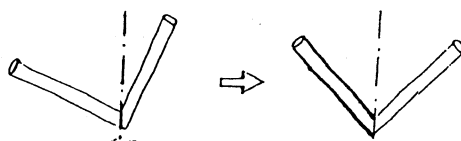

An example: If the body pictured above were rotating about the dotted line (left figure) then it would shift so as to stand up to the point where both ends were at the same height (right figure). In such a position, the body will have it's greatest momentum; it rotates about it's *preferred axis*.

A boomerang does the same thing. It assumes a position in which the wingtips and the elbow are at the same height. Expressed simply, if you turn your

boomerang upside down on the table, with the flat side facing up, you will see the flight position in a hover. The table surface becomes the sky; the axis of rotation goes vertically through the table.

In figures 1-3 the flight position is depicted for the three possible bend-ins (the axis of rotation goes straight through the paper).

Picture #1: Dihedral on the leading arm indirectly causes the trailing arm's angle of attack to be *negative* (Washout).

Picture #2: Conversely, dihedral on the trailing arm causes positive angle of attack (wash-in) on the leading arm.

Picture #3: Dihedral on both arms causes a combination of the two: positive angle on the lead arm, negative on the trailing arm.

Therefore, in all three the lift on the lead arm is enhanced, relative to the trailing arm. Sitting flat or "laydown" is aided. (Continued on next page)

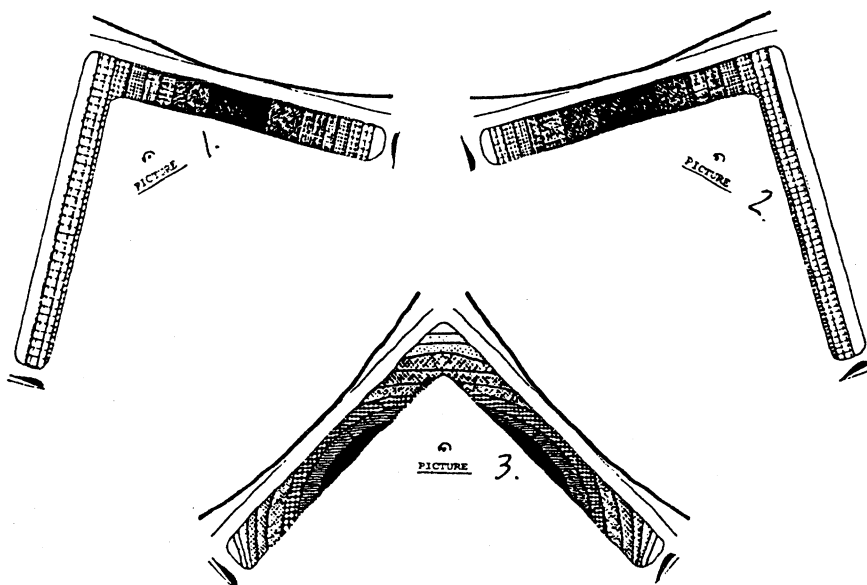



To add to this, there is further effect in flight: when the bent arm is ahead of the center of gravity (like the leading arm in figure 4), the raised wingtip is pointing in the flight direction. The air passes more underneath and creates additional lift. When the bent arm is behind the center of gravity (like the lead arm in figure 5), the raised wingtip is pointing backwards. The air comes more onto the upper surface of the arm with the result of less lift, or even negative lift.

Thus, in a manner of speaking, the bent arm has a variable angle of attack during flight, which is positive when ahead of the center of gravity, creating the hover even earlier.

In the final stages of flight-during the hover-the picture is different again. The trailing arm almost cuts the air with the tip ahead. Similar to a ski, it's better to twist this tip up so it doesn't get forced down. As is well known, dihedral on the trailing arm lengthens hover.

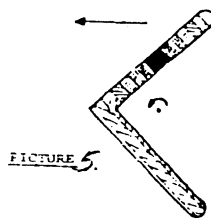
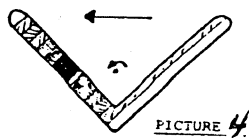

---

## Saint Louis Gateway Classic May 29, 1994

---

The Gateway Classic was preceded and upstaged by the wedding of Chicago Bob Leifeld to Angela \_\_\_\_\_ on Saturday. 'Rangers and family members came from miles around to celebrate the wedding and the sunshine and the fun in Forest Park.

Tournament day saw sunny skies and winds gusting from 10-20 mph all day long. The Australian-American celebration held in conjunction with the tourney brought large and appreciative crowds all day. A Didgerido player, Australian bands, jugglers, kitefliers and boom chuckers all added to the color and festivities surrounding the event.

Twenty-eight throwers and nearly a dozen novice (five alone with the mysterious surname of

"Broadbent") performed mini-wind sprints all day as they tossed and ran after their sailing sticks.

**Chet Snouffer** won the day with firsts in Trick Catch (13), Endurance (45) and Doubling (new world record 21 catches, surpassing Michael "Gel" Girvin's 17 set last year). **Gary Broadbent** was second with firsts in Aussie Round (65) and Fast catch (27.6 seconds). **Mark Weary** was third, **Chicago Bob** 4th, and **Gregg Snouffer** 5th.

Saint Louis' **Andy Bourey** won Accuracy for the second year running with 35 in incredibly tough winds. Fort Wayne's **Sean Marquardt** won MTA with a 35 second toss during one of only a few lulls in the late afternoon winds. Sean was throwing a classic Bailey MTA, spurning the Jonas contingency and their high tech black carbon wizardry. It was kind of a paxolin day anyway unless you were fortunate to get a lull and even that doesn't help if you don't remember how to throw, as Chet

demonstrated by sidearming his Jonas to it's death with a spiral up and down, crashing into a boom bag and shattering along a prior stress crack.

Other scores and performances of note included **Joey Fitzgerald's** 4th place in Aussie Round. **Tim Price** of Michigan tossed a 28 second MTA for 2nd place.

Rounding out the top ten were  
 6. **Aaron** from Ohio  
 7. **Sean Marquardt**  
 8. **Stephan Marguerite**, former Frenchmen, now officially a Canadian Citizen...félicitations!  
 9. Mike Dickson of Canton, OH who withdrew after 4 events with a hamstring injury and,  
 10. John "Hercules" Gorski, of 17 minute MTA fame.

---

## Oakland, CA 4-16-94

---

Mark Weary, of Phoenix, AZ, took four firsts on his way to victory in Oakland this year. Weary tallied firsts in Accuracy (41 points), MTA (27.83 seconds), Doubling (9 catches) and Juggling (21 catches) to wrap up the overall. Host Michael "Gel" Girvin was second, posting top score in Endurance with 29 catches. He added seconds in Aussie and Juggling with a bevu of thirds to beat out Steve Kavanaugh of Seattle for second place. Kavanaugh's seconds in Trick catch and Accuracy were backed by thirds in Juggling and Doubling. Fourth overall went to Eric Fields who won Trick catch with 11 catches. Eric was third in Doubling with 9 catches. Swiss dude Kim Galeazzi, now residing in California, placed 5th overall while Joe Miller won Fast Catch in 25.82 seconds on his way to 6th place overall. Thirteen throwers had fun tossing 'rangs in Oakland in April.

---

## Olympia, WA May 28/29, 1994

---

**Kelly Andretti** hosted this tourney in brutal conditions in the Pacific Northwest. "Thirty to forty mile an hour winds, rain all day, and structural damage to buildings," claimed **Michael Girvin**. "It was horrible (weather)", added Kelly. "However, we all had fun."

The best indication of how difficult the conditions were is a quick glance at winning scores. Fast Catch: 46 seconds. Endurance: 30 . (Both by Gel). In MTA only four people were able to make a catch, with **Gel** sneaking in a 30 second flight. Second place went to **Casey** with 11 seconds, followed by two 7 second throws!

Other events appeared more normal. In what has become almost cliché, **Stevie K.** won Australian Round with 57 points. **Will Gix** won Accuracy with 29. You can count on the Northwest for some colorful personalities and this year was no different. **Spunge** and **Rusty Post** (his real name) took 8th and 9th overall.

---

## Silver Jubilee Albury Boomerang Championships, Albury Australia, May 7, 1994

---

Wow, talk about your legendary tournaments. They don't come any richer in history than the 25th annual Albury Championships in Australia. **The Janetzki's, Jeff Lewry, Bob Burwell, Bunny Read, the Maxwells, Rob Croll, Bruce Carter...**

This year the BAA celebrates

it's 25th Anniversary. On May 6th, **Arthur Janetzki** turned 90 and on the 7th he scored 13 points for 16th in Accuracy at the Championships.

**Bruce Carter** edged Aussie's crème de la crème, **Rob Croll** by 2 points for the overall. Carter did it without winning an event, having learned a thing or two from **Barnaby Ruhe**. His 72 in Aussie was good for 2nd. **Croll** won Trick catch, and other winners included **Adam Carroll** in Fast Catch in 23.65 seconds, **Dennis "The Master" Maxwell** in Accuracy with 45 of 50 points. **Morris Maxwell** won Australian Round with 73 points. Native Australian **Andrew Travis** floated one for 41.91 seconds to win MTA 100.

---

## 1994 Australian National Championships March 19/20 in Sydney

---

**Robbie Croll** has won more tournaments in the past ten years than you and I dream about. In Sydney, he reaffirmed that he's not yet finished with his incredible string of national and international victories by winning the Australian Nationals once again. No small feat in that he not only had to best his countrymen but also defending Aussie champion, **Mathieu Weber** of Geneva, Switzerland! **Weber**, one of the top throwers in the world, won Endurance (50) and Fast Catch (New Australian record 18.51 seconds), his specialties, but **Croll** was able to counter with first in Accuracy (34) and seconds in Endurance and MTA, and never finished lower than 4th in an event.

**Croll** finished with 171 points in the Australian scoring system.

**Weber** tallied 164 for second. Third went to New Zealand's **Earl Tutty** with 163 points. Tutty set an Aussie record 15 catches in Trick Catch. Fourth went to **Adam Carroll** with a first place finish in Australian round with 76 points. **Ian Sproul** came in 5th with a first in MTA at 35.95 seconds.

Twenty-two throwers including venerable tossers **Bob Burwell, Brother Brian Thomas, Kevin Moran, and Ken Arthur.**

---

## Swainsboro, Georgia April 30, 1994

---

**Gary Broadbent** cleaned up in the surprisingly good winds in Swainsboro this year. Broadbent won Trick Catch (14), Fast Catch (23.91), Doubling (11), Australian Round (67). **John Gorski** was second, with seconds in Trick catch (10) and Juggling (24), and thirds in Accuracy and fast catch. Third went to Pennsylvania native **Scott Barrett**, now living in Florida. Barrett won Endurance with 58 catches, took second in Accuracy with 38 and tallied a host of thirds places finishes. **Dennis Joyce** was 4th overall, winning Accuracy with 42 points. Hey, isn't that the event "Uncle Denny" hates because it takes "no skill"? Oh well. Dennis also shares the US record in the event, further demonstrating his complete lack of skill whatsoever.

Other strong showings included Florida's **Rich Surace** in Aussie Round (2nd place 60, tied with tourney host John Derden.) **Jesse Robertson** also came up from the Sunshine state to score 25.77 seconds in Fast Catch for 2nd. **Chicago Bob**, in his last tournament as a bachelor, tallied 2nd in Doubling and placed 5th overall. Sixteen throwers took part in the tournament.



# BOOMERANG SEASON '94

**JULY 16, MERIDEN, NH.**  
SITE TBA. CONTACT JOHN FLYNN at (802) 296-2158

**JULY 16 & 17, OAKLAND, CA. THE 2ND GEL TOURNAMENT.** CONTACT GIRVIN at (510) 658-2469.

**JULY 23 HARTFORD, CT.**  
**Pro-Am team tourney** organized by Larry Ruhf and Paul Sprague. Contact Larry at 413-323-4340 or Paul at (203) 421-4330.

**JULY 24, SALEM OR.** CONTACT DEAN KELLY at (503) 581-8050.

**August 6 or 7 TENTATIVE:**  
**Cuyahoga Valley Cleveland Boomerang School Tourney.**  
Contact Dave Boehm at 216-289-6324

**AUGUST 27 & 28, 15th ANNUAL FREE THROWERS FLING** at MINGO PARK IN DELAWARE, OH. CONTACT CHET SNOUFFER at (614) 363-8332.

**SEPTEMBER 3 & 4, US OPEN.**  
CONTACT BUD PELL at (313) 421-5341.

**SEPTEMBER 5, US NATIONALS, IN JACKSON, MI.** CONTACT BUD PELL. (See Above.)  
**SEPTEMBER 10, HARTFORD BOOM CLASSIC, HARTFORD, CT.** CONTACT PAUL SPRAGUE at (203) 421-4330.

**SEPTEMBER 18, SUMMER'S FINAL FLING.** CONTACT DOUG DuFRESNE at (503) 942-3167.

**OCTOBER 15 & 16, PHEONIX, AZ.** WILDMAN MARK WEARY HOSTS THIS RECORD SETTING EVENT. (See MHR #57) CONTACT MARK at (602) 759-3973.

FOR TOURNAMENT UPDATES OR INFORMATION, PLEASE CONTACT CHET AS SOON AS POSSIBLE FOR INCLUSION ON THIS PAGE.

**CHET SNOUFFER**  
**614-363-4414.**

Remember the new  
**USBA Tournament/Info Hotline.**

Call (614) 369-1085

24 hours a day,

7 days a week

for compete, up-to-the-minute tournament information.

Behind the Back



Hand to Foot

## 10th Anniversary of Gel Boomerangs

*Six different throwers have set  
Nine World Records  
with Gel Boomerangs.  
New designs.*

*Beginner to Expert boomerangs.  
Beginner, Intermediate and  
Competition sets.  
Beautiful Finishes...  
Superior Performance*

### Send for Free Full Color Catalog

GEL BOOMERANGS  
2124 KITTREDGE STREET #61  
BERKELEY, CALIFORNIA  
94704 USA  
(510) 658-2469



For the very best quality Finnish Birch Plywood with a 5% USBA discount:

**Anderson Int'l Trading**  
**1011 West Barkley Ave.**  
**Orange, CA 92668**

(800)-454-6270

(714)-771-6270

# **USBA NATIONALS AT JACKSON, MICHIGAN**

DETAILS: US OPEN - SEPTEMBER 3, 4, 1994  
US NATIONAL CHAMPIONSHIPS SEPTEMBER 5, 1994

PLACE: ELLA SHARP PARK, JACKSON MICHIGAN

HOST: BUD PELL, 33047 CHAPMAN CIRCLE  
WESTLAND, MICHIGAN 48185  
313-421-5341

REGISTRATION AND FEES:  
US OPEN - \$25.00 PRIOR TO AUG. 10, \$35.00 AFTER AUG.10  
US NATIONALS - \$25.00 ON THE FIELD

HOUSING:  
SUPER 8 MOTEL - SPECIAL RATES FROM \$33.19 TO \$44.89  
517-788-8780.  
COUNTRY HEARTH INN - SPECIAL RATES \$46.00 INCL. BREAKFAST  
517-783-6404  
HOLIDAY INN - SPECIAL RATES \$65.00 - \$75.00.  
517-783-2681.

Taxes will be added to above prices. Mention that you are coming to Jackson for the Boomerang Nationals. Make your reservations before Aug 2, Super 8; Aug. 20, Country Hearth Inn; Aug. 12, Holiday Inn.

AWARDS:  
US OPEN - TOP TEN PER EVENT - TOP 12 OVERALL.  
US NATIONAL AWARDS FOR ALL.  
BEST PERFORMANCE UNDER 18 - JUNIOR CATAGORY  
BEST PERFORMANCE OVER 50 - SENIOR CATAGORY

SCHEDULE:  
SAT. SEPTEMBER 3, 1994 - 4 EVENTS CONTESTED W/ 2 TEAM EVENTS. SATURDAY P.M. - DESIGN/ART COMPETITION; MEMBERSHIP MEETING; FASHION SHOW; USBA AUCTION.  
SUN. SEPT. 4 - 3 EVENTS CONTESTED; 2 TEAM EVENTS AWARDS PRESENTED ON THE FIELD.  
MON. SEPT. 5 - 7 EVENTS CONTESTED FOR THE NATIONAL CHAMPIONSHIP. AWARDS PRSENTED ON THE FIELD.

FOOD AND RESTAURANTS:  
CONCESSION STAND ON FIELD. JACKSON IS FILLED WITH RESTAURANTS FROM FAST FOOD TO SIT DOWNS.

**BYLAWS OF THE**  
**UNITED STATES BOOMERANG ASSOCIATION, INC.**

\*\*\*\*

**Preamble**

The name of the corporation is the United States Boomerang Association, Inc. (USBA). The members of the USBA wish to foster all aspects of the sport of boomeranging - competition, art, and science. We wish to strengthen our association with all boomerang enthusiasts in this and other countries, to promote national and international competitions, and to establish uniform rules and regulations for these competitions.

**Article 1: Corporate Purpose**

- Sec. 1 The USBA shall be permanently and exclusively dedicated to the purposes for which it is incorporated under the laws of the State of Connecticut.
- Sec. 2 No part of the USBA's net earnings may inure to the benefit of, or be distributed to, its members, officers, or other persons, except that employees of the USBA may receive reasonable compensation for services rendered in effecting one or more of the purposes of this corporation.
- Sec. 3 The profits and surplus of the USBA, if any, shall be used to further the USBA's corporate purpose.

**Article II: Membership**

- Sec. 1 The membership of the USBA shall be composed of all individuals who have paid the yearly or lifetime membership fee.
- Sec. 2 Membership in the USBA entitles members to participate in all USBA sanctioned competitions and activities, to receive USBA notices and newsletters, to vote at annual and special membership meetings of the USBA, and to be eligible for election to the Board of Directors of the USBA.

**Article III: Board of Directors**

- Sec. 1 The Board of Directors shall consist of:
- a) President
  - b) Vice President
  - c) Secretary
  - d) Treasurer
  - e) Five members at large

Sec. 2 **Powers**

The sole management, control, and direction of all corporate activities and policies and of all real and personal property shall be vested solely in the Board of Directors. The Board President may establish committees to aid in the furtherance of corporate purposes and shall appoint and remove the chairpersons of these committees. The Board shall fix the amount of the annual membership dues effective at the beginning of the corporate fiscal year. The Board shall establish all regulations and policies of the USBA, provided that they do not conflict with the Certificate of Incorporation or these Bylaws. The Board shall also select one of its members to act as a liaison for the United States Boomerang Association to the USBA newsletter, "Many Happy Returns", to assist in the coordination of articles, design, and content, and to be responsible for the timely production and distribution of the USBA newsletter.

Sec. 3 Election

Members of the Board of Directors shall be elected ~~at the annual meeting~~ annually and continue in office for one year or until their successors are duly elected. Nominations shall be solicited from the membership in the Spring issue of the USBA newsletter, or by special mailing during the Spring. All candidates nominated shall be asked to submit biographical and other information which shall be published, with voting instructions, in the Summer issue of the USBA newsletter or distributed to the membership through a special mailing during the Summer with voting instructions. Voting shall be completed, and terms for new directors shall begin by September 5 of each year. Each member of the USBA may cast one vote for a candidate for each of the four offices on the Board of Directors and one vote for a candidate for each of the five at large seats on the Board of Directors. The candidates receiving a plurality of votes cast for each of the four offices shall be elected and the five candidates receiving the highest number of votes for the members at large seats shall be elected.

Sec. 4 Nominations

The Board of Directors shall solicit from the general membership a slate of nominees for the subsequent Board of Directors which shall be published a reasonable time prior to the end of the fiscal year. Under no circumstances shall members be given less than 15 days to vote from the date nominations are mailed.

Sec. 5 Removal

Any member of the Board of Directors may be removed by a two-thirds vote of the members voting at any special meeting of the USBA.

Sec. 6 Vacancy

In the case of a vacancy on the Board of Directors for any cause the remaining Directors, by a majority vote, shall elect a successor to serve the unexpired portion of the term. The Vice President shall assume the duties of the President if that office becomes vacant until such time as a successor is elected.

Sec. 7 Limit in Terms

There shall be no restrictions on the number of terms an individual may serve in any position on the Board.

Article IV: Duties of Officers

Sec. 1 President

The President shall serve as the chief executive officer of the USBA, preside at all meetings of the USBA and all meetings of the Board of Directors, and be responsible for the faithful execution of the business and purposes of the USBA as set out in the Certificate of Incorporation and these Bylaws. He/She shall perform such other duties as may from time to time be assigned by the Board of Directors.

Sec. 2 Vice President

The Vice President shall perform the duties of the President in his/her absence, ~~shall be responsible for the timely production and distribution of the USBA newsletter,~~ and shall be responsible for all publicity involving USBA events. He/She shall perform such other duties as may from time to time be assigned by the Board of Directors. The Vice President shall be in charge of selecting the site for the following year's National Tournament, subject to a vote of the Board of Directors.

Sec. 3 Secretary

The Secretary shall record the minutes of all meetings of the Board of Directors and the membership and shall maintain a current book of minutes of all corporate proceedings. The Secretary shall be the custodian of all official records of the USBA. The Secretary shall give due and proper notice of Board and membership meetings and perform all other duties normally incident to the office.

Sec. 4 Treasurer

The Treasurer shall be the chief financial officer of the USBA, responsible for receipt and disbursement of USBA funds, maintenance of proper records of all accounts receivable and payable, supervision of USBA contracts, and other such duties normally incident to the position of Treasurer of a corporation. The Treasurer is responsible for the preparation, execution and filing of all financial reports and audits as required by federal and state law and regulation. The Treasurer shall prepare once a year quarterly a financial report of the USBA's financial status for distribution to each member of the Board. The Treasurer shall prepare a balance sheet at intervals of not more than ~~twelve~~ three months showing the financial condition of the corporation as of a date not more than ~~four months~~ thirty days prior thereto and a statement of receipts and disbursements for ~~twelve~~ three months preceding such date. The Treasurer shall send membership renewal notices at the beginning of each fiscal year to each member prior to the expiration date of the membership and keep accurate records of current USBA membership.

Sec. 5 Members at Large

The five members at large shall be responsible for coordination of special projects and activities of the USBA when so directed by the Board of Directors.

Article V: Meetings

Sec. 1 Annual Meeting

An annual meeting of the membership shall be held during the Summer months. Notice of the time and place of the meeting, the slate of nominees for the Board of Directors, and the meeting agenda shall be sent to all members a reasonable time prior to the end of the fiscal year.

Sec. 2 Special Meetings

Special membership meetings shall be held at any time upon written request of 10% of the membership or upon majority vote of the Board of Directors. Upon request for a special meeting as aforesaid, the President shall forthwith call such meeting within fifteen days of receipt of the request. Notice of the time, place, and purpose of the meeting shall be given in writing to all members at least ten days in advance of the meeting and no business can be transacted other than that which appears in the notice.

Sec. 3 Board of Directors Meeting

The Board of Directors shall meet at least every four months at a time and place or manner specified by the President. Notices for such meetings shall be mailed or telephoned at least three weeks prior to the meeting. A telephone conference call, or ballot mailing is considered a proper and adequate means of conducting such meeting. The Board of Directors shall meet ~~immediately after~~ within two weeks of the annual membership meeting to set the membership fee, budget, and program of work for the following fiscal year. Monthly correspondence by the President or his/her agent shall be ~~considered the monthly Board meeting required~~.

Sec. 4 Conduct

The President, or in his/her absence the senior officer there present, shall conduct all membership and Board meetings. The Secretary, or in his/her absence a person duly appointed by the presiding officer, shall record minutes. Meetings shall be conducted pursuant to Roberts Rules of Order.

Sec. 5 Voting

Each member of the USBA may cast one vote in person or by proxy on each matter submitted to the membership for action.

An affirmative majority vote at any general, special, or Board of Directors meeting at which a quorum is present shall be necessary for any corporate action.

Article VI: Quorum

Sec. 1 A quorum to do business at any meeting of the membership shall be 10% of the membership.

Sec. 2 A quorum to do business at any meeting of the Executive Board shall be ~~four~~ five members of the Board.

Sec. 3 A quorum to do business my mail ballot shall be 10% of the membership.

Article VII: Fees

Sec. 1 The annual membership fee for each member shall be payable to the USBA, Inc., and shall be paid annually.

Article VIII: Dissolution

Sec. 1 Upon dissolution, all assets shall first be used to discharge all obligations of the corporation. Any remaining assets shall be distributed to the Museum of Flight, Seattle, Washington, a non-profit corporation exempt from income tax under Sec. 501 (c) (3) of the Internal Revenue Code of 1954 as amended, and/or any other similarly exempt non-profit organizations.

Article IX: Amendments

Sec. 1 These Bylaws may be amended at any meeting of the general membership, or by mail ballot, provided notice of the proposed change shall be sent to all members at least 30 days prior to the meeting and two-thirds of the members voting at the meeting vote to adopt the amendment.

Article X: Archives

Sec. 1 The Smithsonian Insitution shall be the official custodian of the USBA archives.



**OTHER AREA MOTELS:**

**BUDGETEL INN - 1-800-428-3438; ROADWAY INN - 517-787-1111  
COLONIAL INN - 517- 764-3820; MOTEL 6 - 517- 789-7186.**  
*Camping is also available, Call Bud for more information. **A commemorative T-Shirt will be available on the field.***

**ABOUT JACKSON, MICHIGAN**

The city of Jackson is in southern Michigan about an hour west of the Detroit Metro area on Interstate I-94. Jackson, Population of about 50,000, has a wide variety of activities for the non-throwing members of the family to partake in. Things like the Michigan Space Center, The Cascades, numerous golf courses, Harness Racing, Museums, Gilbert Hand Dipped Chocolates, The greatest ice cream parlor in the midwest and many other attractions and shopping centers.

Throughout the summer, Jackson hosts many excellent events such as a Civil War Muster, a Balloon Festival, National Softball Tournaments, a Blue Bird Festival, Bike Racing and three major Auto Races (Nascar and Indy) at nearby Michigan International Speedway.

So plan a few extra days to relax and enjoy this wonderful southern Michigan community. Please let "Just Plain Bud" know if you want Jackson Action information and he'll mail you all the good stuff in time to plan your vacation.

**Jackson Area Map**

Follow the green and white "trailblazer" signs to Ella Sharp Museum

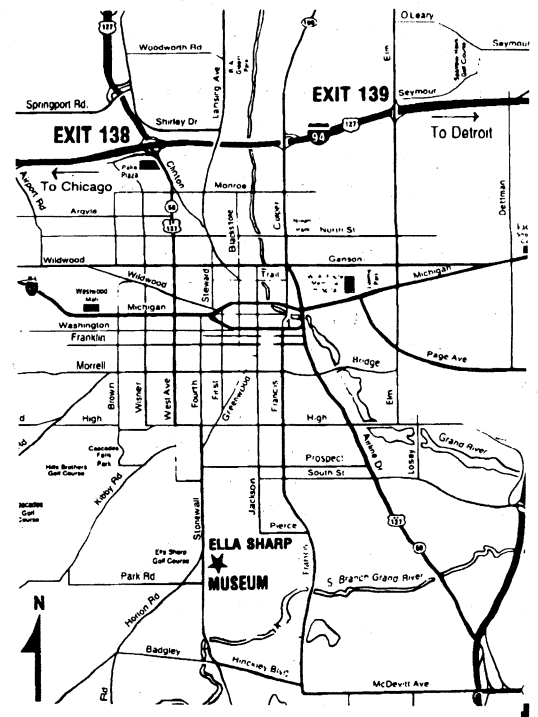

**USBA OPEN AND NATIONALS REGISTRATION FORM**

Please fill out this form and return it by August 10, 1994 to:  
"Just Plain Bud"  
33047 Chapman Circle  
Westland, Michigan 48185  
\$25.00 before Aug. 10, 1994 - \$35.00 after Aug. 10, 1994

NAME: \_\_\_\_\_

ADDRESS: \_\_\_\_\_

PHONE: \_\_\_\_\_

**DESIGN/ART CONTEST  
NO CHARGE**

**MAKE CHECKS PAYABLE TO C. PELL**

YES \_\_\_\_\_ NO \_\_\_\_\_

# BITS & PIECES

## News from the USA

**Chicago Bob** has started publishing a new newsletter geared for the competitive thrower. The Competition Update will be published every four weeks or so during the competition season, April through October, and any other months in which boomerang tournaments take place around the country. The goal of the newsletter is to keep throwers from coast to coast up-to-date with tournament results and records from across the country. Each issue will contain that month's tournament results, printed in detail as well as the current, up-to-the-minute National ratings and Tournament Calendar. Features might be road trip stories, tournament reviews, details of records or feats, features on what the top throwers are using to get their best scores and set records, and other humorous and entertaining articles. The cost of the newsletter is \$7.00 per year for US subscribers, \$15.00 for overseas throwers who wish to keep track of what is happening in the US. If you want to subscribe, please write to:

**CHICAGO BOB**

P.O. BOX 242  
WATERLOO, IL 62298-0242  
or call:  
(618) 282-6854

**Ted Bailey** of Ann Arbor, MI and longtime boomerang ambassador recently sent out a mailing to past members of the USBA encouraging them to once again give the organization a try. The results of Ted's efforts are astounding, as the membership of the USBA has increased by over 100 members from the last issue of MHR. This editor would personally like to thank Ted for his monumental ef-

fort, which I may add was done completely on Ted's own personal time. Mr. Bailey is the editor of **Boomerang News**, a outstanding publication featuring many scientific and creative aspects of the boomerang world. This publication is a must have for every boomerang enthusiast. The publication is informative and reliable in delivery time and comes out six times a year. USA subscription rate is a very reasonable \$8.00 per year, overseas rates are \$2.50 US funds per issue. Interested parties may contact Ted at:

**TED E. BAILEY**

P.O. Box 6076  
Ann Arbor, MI 48106  
313-971-2970

**Michael "Gel" Girvin** has been busy at the design table once again. His new design is the "Sunbell". A mutation of two of "Gel's" most famous designs (guess which ones, duh!) this boomerang slices wind like a hot knife through butter. The range on the Sunbell is between thirty and forty meters without additional weight and the editor found this boomerang an extremely worthy addition to the "Gel" boomerang line. All of Michael's boomerangs are flight tested before delivery, decorated with hot "rad" paint jobs and guaranteed to make you whoop it up on the field. To order the new "Sunbell" or any other "Gel" boomerang, Girvin will send a full four color catalog for convenient home shopping. Michael is very reliable on delivery and is happy to give any throwing and tuning instruction. (All Booms come with detailed throwing instructions) Contact "Gel" at:

**Gel Boomerangs**

2124 Kitteredge St. Box 61  
Berkeley, CA 94704  
510-658-2469

**Mark Eskanos, of Perry & Butler Reality, Inc.**, found a perfect way to increase business in the Englewood, Colorado area. He was prospecting and met an Australian importer who moved to the states and opened business, with 1,100 extra boomerangs on hand. Eskanos and his wife, who's also a salesperson, pride themselves on their referral business. So, boomerangs, which are designed to return to the thrower, turned out to be a natural promotion. The couple mailed the boomerangs out at 19 cents a piece along with the copy of their newsletter. Their boomerang slogan was "People always come back to the champions of service." Mark says the phone is still ringing with thank yous and referrals. (Who is this masked Aussie? Ed.)

**Australia Dreaming Inc.**, of Middletown, RI, is marketing a unique personal greeting called the Boomer-Gram

**BOOMER-GRAM**  
A TRULY UNIQUE & LASTING GREETING  
**MANY HAPPY RETURNS!**  
Send an authentic Australian wooden Boomerang, the symbol of return and renewal. Crafted by aboriginal people, each Boomerang features an original hand painting. Your personal "Many Happy Returns" message will be inscribed on the reverse side. A gift to be kept and proudly displayed. Give It A Go! Call today and we'll get your birthday greeting on its way! MAJOR CREDIT CARDS ACCEPTED.  
**1 800 390 BOOM**  
Approx. 12" Long  
Only \$29.95 plus \$7.00 S&H  
TOM, MARY  
YOUR MANY HAPPY RETURNS ON YOUR 40TH BIRTHDAY! LOVE, MARY  
AUSTRALIA DREAMING INC.  
P.O. Box D, Middletown, RI 02842

## News From Canada

**Stephane Margurite**, obtained his Canadian citizenship on April 14, 1994 and will be competing for the Canadian team at the World Championships in Japan. Stephane brought his "boomstreet" to secure his citizenship just a bit faster. He posed in front of a picture of the Queen, the Judge, and of course...the boomerang.



**TEAM U.S.A. — WINGING THEIR WAY TO JAPAN**

### **NOTICE TO MEMBERS**

The USBA is seeking a new Editor for the Many Happy Returns Newsletter to begin immediately. If you have enthusiasm for the sport, art, and science of boomerang throwing and want to make a difference, this is your chance! A computer with printer, some free time to give, an eye for detail, and a sense of humor round out the requirements to be a successful editor. For information and/or to apply contact Betsylew Miale-Gix [(206) 485-1672], Norm Kern [(313) 645-9308], or Chet Snouffer [(614) 363-8332].

### **PANORAMA TRAVEL CENTRE**

877 S. Tustin St.  
Orange, CA

Call: (714) 633-4640

Fax: (714) 633-4751

(800) 285-0800

Lewis & Betsy Miale, Owners  
"The Boomers Choice"

# TOSS ACROSS AMERICA

The Toss was a great a great success this year with a full seven locations reporting. The reports will be brief due to space limitations, but a great time was had by all and a good number of new throwers were introduced to the sport!

**Kingston, Rhode Island.** Sam Lemay hosted the the Toss doing the demos and teaching himself at the University of Rhode Island. Although there was no media coverage, six people showed to demonstrate their newfound Boomerang skill. Weather was perfect for the novices with 5-15 MPH winds. Sam reports four of the first time throwers made excellent catches and all had a lot of fun. Accuracuy was played until sunset.

**Canton, OH.** Mike Dickson histed his throw at Dermshire Park in Canton with a nice turnout of thirty throwers. The Canton Repository covered the throw with a full page cover story in the Leisure section of the Sunday Edition.

Three throwers "from the 80's showed up," Andy Esway, Tom Evans and Virgil Martin. Andy and Tom had numerous Bunny Read and Carl Naylor booms in their bag. Virgil had beautiful strip laminated omegas he had made himself. Several of the kids really got the hang of it. Great weather and light winds kept the crowd well into the evening.

**West Hartford Conn.** , Hosted by the Wandering Nutmeg Boomerang Society. The throw was spectacular with 15 veteran throwers haosting the event.

Before the event, every major newspaper in Connecticut was hit hard. Three radio stations did interviews. On the Brad Davis morning show (WDRG, 1360 AM ,) Brad challenged Beesley

Reese, another local celebrity, to a boomerang toss. Two TV stations sent crews to the field on a beautiful day. Attendance was 85 people at \$5.00 per head. Gate receipts and a percentage of the sales went to the Science Center of Conn. for their efforts in promotion and logistics.

**Allentown, PA.** Hosted by Dave Hendricks at the Cedar Parkway. 60-70 people turned out on a 70 degree day with light wind. Seven expert throwers helped the novices get educated to the sport of booms. Dave says plans to form a local Boom Club are in the works.

**Casa Grande, AZ.** Hosted by Mark Weary and Jeff Crandel. The local paper announced the Toss 2 days before and was responsible for several of the people coming out. The day and the weather were excellent in the desert. Mark and Jeff both launched MTA throws that exceeded 1 Min 15 secs..

**Ottawa, Ontario** , at the fields outside the National Aviation Museum. Hosted by Team Cananda: Eric Promislow, Ken Farr and Stephane Marguirite. Eighty people showed up to toss including several interested cyclist passing by. The local CBC radio show "IN Town and Out" aired an interview and that attracted about a dozen people as well The local TV station sent their regrets as they were too busy with the Jackie O. funeral. The winds were light until about 2:30 in the afternoon when the group was afforded the chance to pull out their Big Hooks. Next year the Toss will be held on a Sunday, a traditionally busy day at the Museum, and tthe Canadian team hopes for a much better turnout.

**Northville, MI.** Hosted by Bud Pell and Norm Kern. About thir-

ty throwers came out on a sunny afternoon. WJR, a local radio station, gave some coverage to the event and a few of the participants came because of the "cool" commercial for the Park System featuring a slogan "There really is a Boomerang field there." Bud gave his usual excellent demo on the history of boomerangs and a great time was had by all.

## HOT STUFF

**100% Cotton Heavy weight T-Shirts**

Style A - Magic in motion



\* front \$15

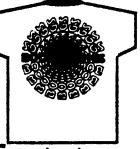

back

Style B - Glim on Boomerang



\* front only \$12

Style C - Insomniac Theatre



\* front only \$15

\*Available in adult sizes- specify sm-md-lg-xl  
For xxl add \$2

**NEW PROJECT 6 Boomerang**  
\$22 5 ply finnish birch/classic V shape  
designed & crafted by Mike "Gel" Girvin

**Also PROJECT 6 "Guitar Corral" Cassette**  
includes the song  
"Boomerang" 4 songs \$4

all prices include shipping  
add \$4.00 for C.O.D.  
please allow 2-5 wks. for delivery  
California residents add 8.25% sales tax

Send your order to:  
**Offshore Screen Printing**  
1830 B. Palmetto Ave.  
Pacifica, CA 94044

Page 14

Many Happy Returns

Issue No. 59

# **USBA OFFICIAL BALLOT OF CANDIDATES 1994 -1995 BOARD OF DIRECTORS**

## **PRESIDENT: VOTE FOR ONE CANDIDATE ONLY**

\_\_\_\_\_ **CHET SNOUFFER:** Delaware, OH. Current Vice- President. Chet maintains the USBA office with Gregg and answers all general inquiries received at the USBA. Competition editor for MHR. Would like to see opur focus on grass roots developmment and local club developmment to further growth of the sport. Focus on improved content, quality and timeliness of newsletter. Eliminate many costly services to non-members and improve national promotion of USBA membership.

## **VICE PRSIDENT: VOTE FOR ONE CANDIDATE ONLY**

\_\_\_\_\_ **MARK WEARY:** Pheonix, AZ. Current Board member. Mark has served on team selection committee and rules committee.

## **SECRETARY: VOTE FOR ONE CANDIDATE ONLY**

\_\_\_\_\_ **GREGG SNOUFFER:** Current USBA Secretary. Gregg maintains all mailing lists, and with Chet, now prints nad mails MHR directly from the USBA office.

## **TREASURER: VOTE FOR ONE CANDIDATE ONLY**

\_\_\_\_\_ **GERARD GIX:** Seattle, WA. Retired businessman with longstanding interest in boomerangs. Has time and computer to maintain financial records for USBA.

## **MEMBERS AT LARGE BOARD OF DIRECTORS: VOTE FOR FIVE (5) CANDIDATES ONLY**

\_\_\_\_\_ **VERA BROADBENT:** Canton, OH. Teacher. Vera has a Masters in Physical Education from U. Akron. Has developed a series of lesson plans for use in classroom by teachers. Wants to see implementation of age/ skill divisions to encourage participation, as well as modify ratings system, and standardize team selection for US competion teams.

\_\_\_\_\_ **MIKE DICKSON:** Canton, Oh. Lonf time thrower and competitor from the mid-west.

\_\_\_\_\_ **SEAN MARQUARDT:** Fort Wayne, IN. 7 years Thuba co-founder. BS in management, Purdue. 5 years at Junior Acheivemeent organizing volunteers and running special events. Wants to further his love of the sport. Make it fun for everyone, not just the competitors.

\_\_\_\_\_ **TIM PRICE:** Livonia, MI. Tim has many years of experience organizing non-profit and volunteer activities such as the Indian Guides and Cub Scouts. Gives Boomerang demos in his community. Wants to standardize team selection, competition reform to speed up tournaments. Strengthen USBA membership by brodening the appeal of boomerang to the general public.

\_\_\_\_\_ **BETSY LEW MIALE-GIX:** Current and Past President of USBA. Attorney. Initiated the Toss Across America and has worked to promote grass roots involvement in the sport.

\_\_\_\_\_ **CHICAGO BOB LIEFELD:** Red Bud, ILL. Objectives are to increase the memberhsip USBA. Revise team selection standards. Increase accountability to the general membership. Involve general membership in decision making process.

PLEASE MARK YOUR BALLOT AND MAIL BY AUGUST 26, 1994.

**USBA  
PO BOX 182  
DELEWARE, OH 43015  
ATT: ELECTION COMMITTEE**

You can also vote at the Nationals in Jackson, Michigan if you do not mail this form.

---

---

## THE SOLUTION TO A DESIGN PROBLEM

---

---

By Ed B. Russell

When the outlines of boomerangs have the angle of the elbow less than 70 degrees, the wash from the leading arm as it meets the trailing arm can affect its performance.

The advantage can be nullified by separating the planes of each by attaching them at the elbow with a lapjoint, see sketch of lapjoint.

This comment only applies to two bladers made from plywood no thicker than 4 mm., which can be glued with adhesive such as epoxy resin. Not plas-

tics such as polyethylene nor polypropylene which resist epoxy. The sketch of the lapjoint section shows how airflow is taken care of by fillets in the corners, made with epoxy.

An experiment was performed using the lapjoint procedure with five designs having the angle of the elbow less than 70 degrees, each made from 4mm marine 3 ply. The arms of every shape were arranged so that the grain of the 3 ply ran lengthwise to provide strength and stiffness.

The photo A-E shows the five boomerangs, A is J. Schlegel's Old faithful, less storkorpers, wt, 55 gms, angle 55 degrees: B is Dimana's T>L> Poquet's

Spinracer, wt. 33 gms, 46 degrees; C is Dimana's Atlas #6, wt. 39 gms, 30 degrees; D is Jim Mayfields Matterhorn, wt. 50 gms, 33 degrees; E is T.W. Smith's Scissortail, wt. 47 gms, 45 degrees.

Photo F show the corners of the elbows rounded to lessen air resistance due to double thickness of joint.

Oddly enough, while the original Matterhorn required weights at the tips, the 4 mm model needed none. Neither did the Scissortail, which proved to be a first class boomerang. Photo G of the un-

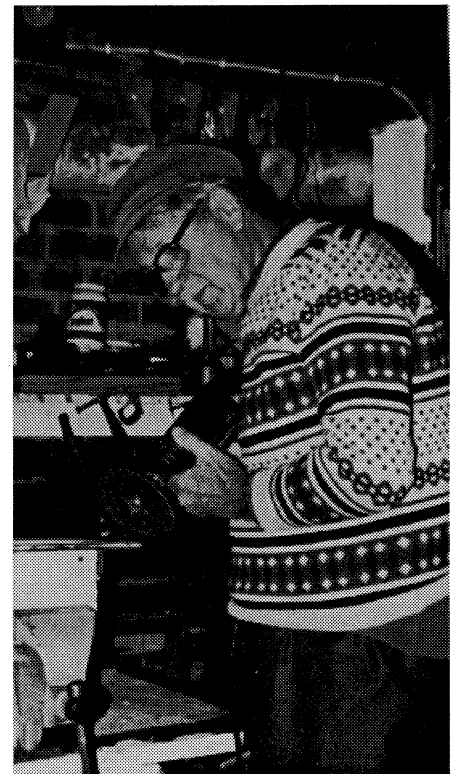
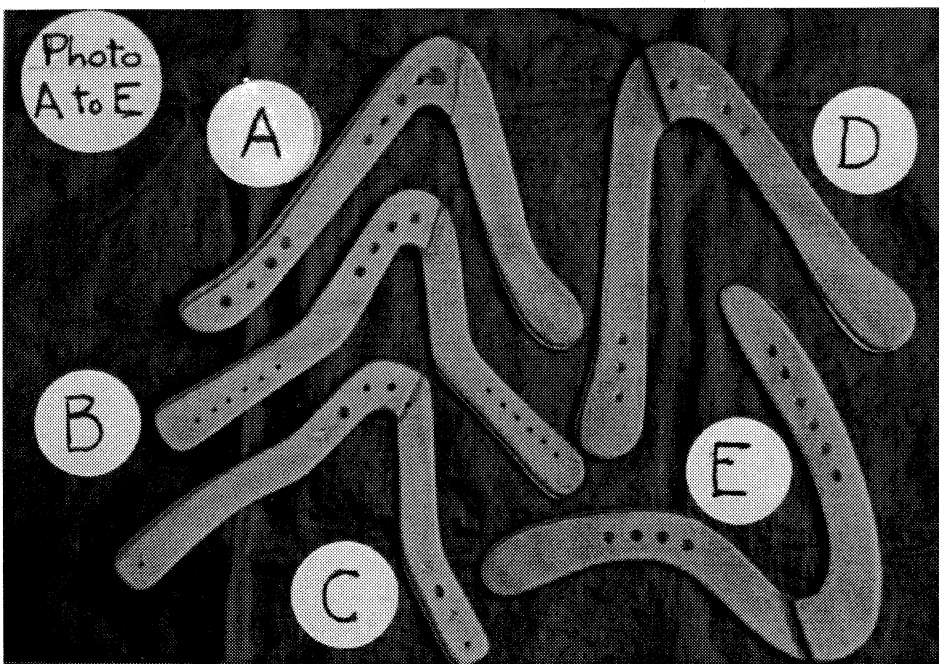

Ed B. Russell - 1992





derside of the other three shows how coins were fixed. The now out of circulation Australian 2 cent pieces weighed 5 gms while the 1 cent was half that weight.

All were succesful flyers in lights breezes, so the lapjoint elbows were appropriate alternatives to some rangs' instead of being made in one piece.

The idea was not original. Some time ago, Brian Kemp commended that a lapjoint elbow could be used on a "Midge" MTA, 50 degree elbow boomerang, instead of placing twist on the trialing arm and this change worked very well. So the above solution is merely an extension of the lapjoint idea to boomerangs having angles less than 70 degrees.

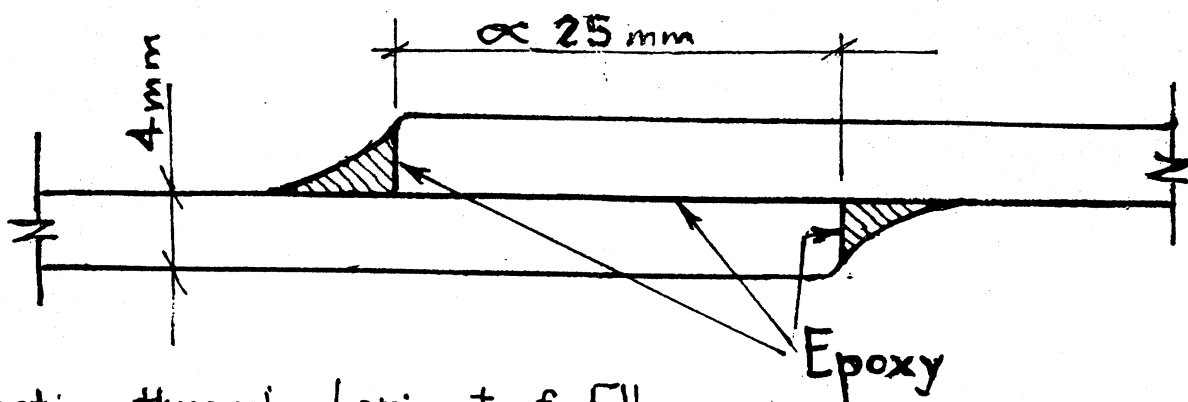
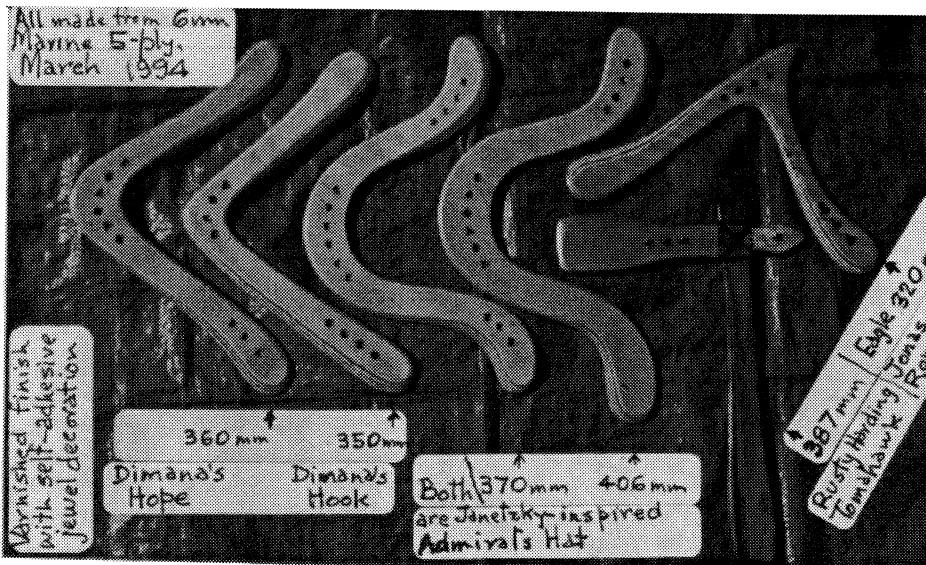

Section through Lapjoint of Elbow.  
60mm width of lap weighs 4gms

# USBA MEMBER PROFILES

## LONDON HOFT

Resides: Oaktown, CA

Occupation: Tree Doctor

Age: 26

*Favorite food:* Big o; steamers with lots o' garlic

*How did you get involved in boomerangs?:* Friends dragged me down to the Billy Martin field in Oaktown, and introduced me to Mike Girvin, enuff said!

*Favorite type of Boom Throwing:* Sunny day in the mountains on a grassy plain with a slight buzz on throwing trick breeze with a little wind.

*A Good Boom Story:* I came out to the park to throw on a Saturday when suddenly I was overwhelmed with the f---ing paper work, stop the reading and go throw.

*Words to the members?* I'm new to the whole scene but psyched to meet Huckers. Where's all the chicks?



LONDON HOFT ANGLED

## STEPAHNIE MARTIN

Reside: Oakland, CA

Age: 27

Occupation: Special Ed. Teacher

*Favorite food:* Greek Olives

*Started Booming?* Through Girvin

*Favorite type of boomerang*

*throwing?* I enjoy team events i.e. Hackuarracy, Team Hacky Catch, whoa Nelly.

Best event: Accuracy

*Good boom story:* I broke my ankle at a tournament trying to do a foot catch in doubling, and I got placing points!



STEPAHNIE CASTED

## JOE MILLER

Residence: GLORP, temporarily California.

Age: 329 years

Occupation: Rock Star

*Favorite food:* Hot!

*Started Booming?* My pet Glim taught me on GLORP (the planet I reside on.) On GLORP we call boomerangs Bel-Aires.

*Favorite type of boomerang*

*throwing?* All day GLORP

Best Event: GLORP

*Good Boom Story?* The day Glorp as Boomerang event was invented. Koko Chavez, Chris Walcott & I were playing B-Ball & some idiot removed our backboard, so we split to the park & played our game of boomerangs (a variation of "Horse" called "GLORP" named after our home planet) thus GLORP was invented.

*Words to the members?* GLORP rules! Nothing else matters, play GLORP, it's easy to score, fun to

watch, and the radest game ever to play. Learn to play GLORP now!



JOE GLORPING!

## TOM LANGLAND

Reside: Tracy/San Ramon, CA

Age:33

Occupation: Computer Scientist

*Fav. Food:* Garlic Chicken Pizza

*Got Involved in booms?* My brother and I Bought a couple of Booms at a Kite store. Went to a field and gave them a heave. After about an hour we were catching them and were hooked!

*Fav. type of throwing:* Juggling 2 at a time

Best Event: Accuaracy

*Good Story?:* One day at lunch at work I was out on the field on-site and managed to get three of my booms caught in a single tree. After I got my favorite boom stuck, I decided it was time to quit throwing and climb the tree.



# USBA INFORMATION PAGE

## Many Happy Returns

Circulation: 400 Worldwide.  
Published by the:

**U. S. Boomerang Association**  
P.O. Box 182  
Delaware, OH 43015

**Mechanical Measurements:**  
Image area: 9.5" deep by 7.5" wide; 3 columns to a page; width of a single column: 2.25"

### Advertising Rates:

|                 |       |
|-----------------|-------|
| Full Page       | \$200 |
| 2 Columns       | \$150 |
| 1/2 Page        | \$115 |
| 1 Column        | \$80  |
| Per Column inch | \$10  |

10% discount for 4 consecutive issues. All advertisements must be pre-paid in USD by check or M. O. to USBA. Camera-ready copy preferred. The editor reserves the right to refuse any advertisement or cancel a contract without reason. The deadline for all advertisements is March 1, June 1, September 1 and December 1 for the Spring, Summer, Fall and Winter issues respectively. All advertisements should be mailed to:

**USBA**  
P.O. Box 182  
Delaware, OH 43015

Questions regarding *newsletter delivery status* should be directed to the editor: **Gregg Snouffer** by calling (614)-363-4414 or by writing to:

**Gregg Snouffer**  
340 Troy Rd.  
Delaware, OH 43015

All newsletter submittals, with the exception of competition; should be directed to the editor: **MHR**

**USBA**  
P.O. Box 182  
Delaware, OH 43015

## USBA INFORMATION

The USBA provides information listings to members at a nominal charge. A listing of boomerang manufacturers; a listing of wood sources; and a listing of boomerang clubs can be obtained by sending a SASE. Allow one ounce postage per listing. A sampling of vendor catalogs or a USBA rule book costs \$2 and a self addressed envelope (no stamps). Send all inquiries to:

**USBA**  
P.O. Box 182  
Delaware, OH 43015

Chet Snouffer will respond quickly to special inquiries that are mailed to: Chet Snouffer; 51 Troy Rd.; Delaware, Oh 43015. In the event of an emergency, you can contact Chet at (614)-363-8332 (9 -12 AM EST).

## USBA BOARD OF DIRECTORS

### President

Betsylew Miale-Gix: (206)-485-1672

### Vice-President

Chet Snouffer: (614)-363-8332

### Treasurer

John Flynn: (802)-296-2158

### Secretary

Gregg Snouffer: (614)-363-4414

### Directors

Kelly Croman Andretti: (206)-866-6579  
Michael Girvin: (510)-658-2469  
Dean A. Kelly: (503)-581-8050  
Norm Kern: (313)-645-9308  
Mark Weary: (602)-759-3973

All materials related to competition notices & results should be sent to the Competition Editor: **Chet Snouffer:**

**Chet Snouffer**  
51 Troy Rd.  
Delaware, OH 43015

All newsletter submittals related to Science & Technology and the "Bits & Pieces" column should be sent to the Science and Correspondence Editor:

**USBA**  
P.O. Box 182  
Delaware, OH 43015

## USBA MEMBERSHIP INFORMATION

All membership dues should be paid by check or money order in \$USD\$. Make checks payable to: USBA. Domestic and Canadian annual membership dues are \$10 per year. A domestic lifetime membership is \$150. Annual overseas dues are \$20. A lifetime overseas membership is \$250. Check your newsletter label for expiration issue. Mail all checks or money orders to the address below:

**U. S. Boomerang Association**  
P.O. Box 182  
Delaware, OH 43015

*Membership status* questions should be directed to **Gregg Snouffer** by calling (614)-363-4414 or by writing to the above USBA address.

## New Member Application

Instructions: USBA member should copy this page and fill in his/her name as sponsor. Carry extra copies of this sheet in your boomerang bag and hand them out to potential new members.

name

address

address

city/state/zip or country

phone number (optional)

USBA member sponsor's name

New member: Please read USBA Membership Information above. Send the completed coupon and (\$10) check or M. O. to:

**USBA**  
P. O. Box 182  
Delaware, OH 43015



**PRINTED MATTER**

**UNITED STATES BOOMERANG ASSOCIATION  
P.O. Box 182  
Delaware, Ohio 43015  
U.S.A.**