

Many Happy Returns

Issue 71

Newsletter of the United States Boomerang Association

Winter 1998

Make Your Own Boomerangs

A primer for the beginning boomsmith

page 12

Also:

Plans!

page 7

Product Reviews

page 16

Pets and Boomerangs

Meet the real animals of the boomfield

page 4

Tips for Cold Weather Booming

page 7

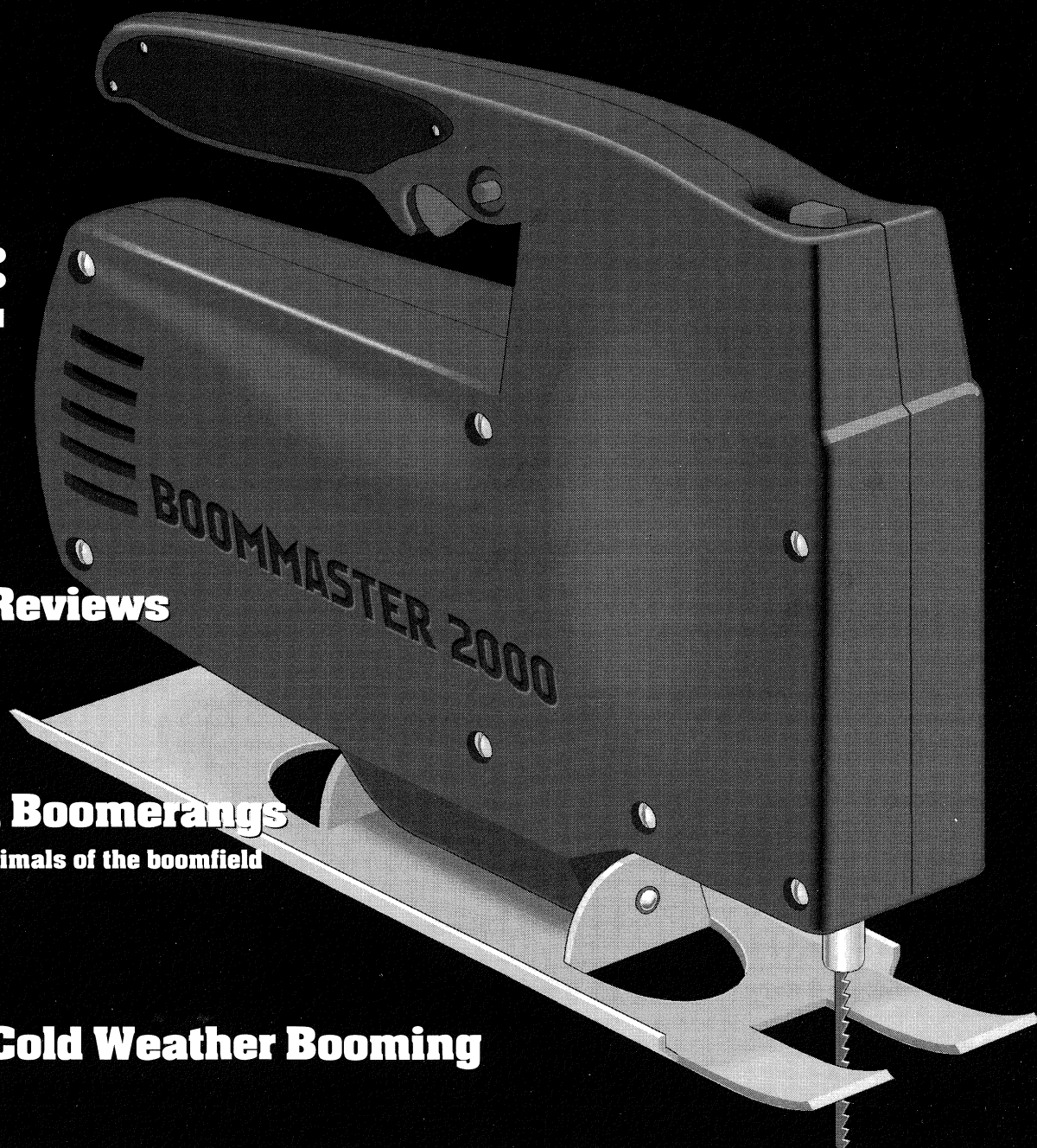

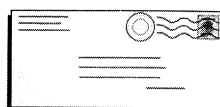

Letters

Your article about the USBA elections (MHR #70, Fall 1997) was a bit negative, for obvious reasons: People need to put up, or shut up, right? Well, my experience with many volunteer organizations is that people will always whine and moan but not want to do anything concrete about it, or serve on the board. That is their democratic right, unfortunately.

The whining and moaning and bitching reminds the board what the members want, and can influence the board in its decisions. So, while non-constructive criticism really is just a big waste, criticism with solutions attached can help construct new ideas and push us all forward.

The idea of a democratic organization is sound, but the fact is that a very small percentage of the members decides what is going to happen. It's called a board of directors, and it's elected by the same members who criticize it. The only way the members can take part is to criticize and suggest, or when they vote every year.

What the heck does all that mean? If the USBA is to be democratic versus autocratic (as some would suggest), then the board must put up with missiles, complaints, gripes, whining and tirades. It is part of the process of democracy and will NEVER change. Nor will the simple fact that there will ALWAYS be only a very small core group of people willing to dedicate themselves for zero personal gain to a cause which is guaranteed to bring them a lot of pain: voluntary service to a non-profit organization.

To all the USBA members who have something to say: bring it on, baby! Just try to be as constructive as you can, and remember that

your board is completely human. Being human, they tend to react better to honey than to hammers.

*John Koehler
Virginia Beach, Virginia*

I am an elementary art teacher in Bartlesville, Oklahoma and have been making wooden boomerangs for about seven years.

rates two paint paddles which I have carved. It takes me about one hour to carve and sand 40 paddles (enough for 20 students). After decorating with paint or markers, the two sticks are fastened together with rubber bands to make a four-wing boomerang. These booms are great for near windless days or inside a gymnasium.

My students learn the history of the boomerang and the aerodynamic principles that govern the flight of a boomerang, as well as how to throw and catch their boomerangs. Students get the experience of making a work of art that is also a toy.

I wanted to pass along my ideas to anyone making a boomerang curriculum for use in schools.

*Steven R. Graham
Bartlesville, Oklahoma*

Editor's note: Mr. Graham sent in one of his paint paddle booms with this letter. It is the best-flying paint paddle boomerang I have ever tested.

My son, Joseph, is very interested in doing his project on boomerangs this year. He is very interested in them, but I need

some ideas and info on where to purchase booms for his experiment. Any suggestions. He is 12 and is just a beginner and knows very little. We would like to possibly tie wind speed and different booms to see possibly which is best on calm day, windy day, etc. How do you learn to throw? I plan to order info off internet. Thanks for any help you can offer.

After response from USBA Treasurer Gregg Snouffer:

We received the package you mailed yesterday. My son was so excited. Who knows you might just have gained another boomeranger! He loves it. He pitches in baseball, so he throws pretty well already. All he needs now is lots of practice. Thanks for the help. I know he'll make an A on his project.

Kathy Cress

Quarterly Quote

"It makes a weird kind of gyroscopic sensation, like you are wrestling a barbiturate-drugged weasel."

*- Fred Malmberg
page 10, this issue*

I have just recently become a member of the USBA.

I sell boomerangs at Smart Toys, a toy store in Bartlesville. I also personalize boomerangs to order. In the future I plan to sell boomerangs at local area arts and crafts fairs, and someday plan to have my own website for Graham's Boomerangs.

My fourth and fifth grade elementary art students make boomerangs using paint stirring paddles, which Wal-Mart donates (I love free art supplies!). United coatings makes the paint paddles that Wal-Mart donates. I have found these paint paddles to make better boomerangs than some, which were of a softer, lighter wood and were longer and therefore flew with too much drag. Each student deco-

www.staff.uiuc.edu/~brazelto/MHR.html

Be sure to look for these little boxes throughout *Many Happy Returns*. These contain web addresses where you can find certain articles and resources on the USBA website. In many cases, the web versions are enhanced, more detailed, and interactive.



1998 WORLD BOOMERANG CHAMPIONSHIPS



St. Louis
USA

Sunday, July 26
Registration and Welcoming Reception

Monday, July 27
Team Test Match I

Tuesday, July 28
Team Test Match II

Wednesday, July 29
Exhibitions

Thursday, July 30
Team Test Match III

Friday, July 31
Individual World Championship

Saturday, August 1
Individual World Championship

Sunday, August 2
Exhibitions
Farewell Party

July 26 - August 2, 1998
Southern Illinois University
Edwardsville, Illinois
(in the St. Louis metropolitan area)

Registration Fee for
Individual World Championship
\$75 before July 1 (includes T-shirt)
\$125 July 1 and after

Tom Fitzgerald
Tournament Director
(314) 839-1604

www.htc.net/~chibob/worldcup.html

I have made boomerangs with hand tools and have tried to help people make them with hand tools. It takes significant effort, especially the trailing edges. People constantly ask "Is this good enough?" Many people give up before they finish.

I recently ran a workshop and in preparation, I cut in all the trailing edges, and on each boom roughed in one leading edge. I told the students, it was their job to make the rest of the unfinished edges like the leading edge I had roughed in. When all the edges looked the same, then they could sand the leading edges smooth. Little interim direction was required, and everyone did a fine job. All 9 students were making good throws and some catches within about 45 minutes of beginning. I provided some MHR articles on making boomerangs, some throwing directions, how to make an indoor boom' from card board, and the 'Join the USBA' flyer. Cutting in the trailing edges and the single lead edges on 14 booms took about 45 minutes with power tools and made the whole project a great success. Most blanks were 4 mm thick which makes it easier for a student with hand tools than it would be with 5 mm blanks.

*Norm Kern
Birmingham, Michigan*

You gotta love the great MTA debate, the oldest argument known to man other than "Which came first, chicken or egg?"

I say that MTAs are real boomerangs: They precess and generate lift through an airfoil - the basic requirements of a boomerang. If you bend the arms down on an MTA, it will fly just like a regular boomerang. So, we have a regular boomerang that is tuned for high performance. Is a Fast Catch not a real boomerang since it doesn't lay down? Just another regular rang tuned for high performance.

An MTA would come back to within a few meters of the thrower if it were not for the winds. I won MTA in Avon, Ohio a couple of years ago with a 1:06.04 that probably traveled about 10 or 15 meters because the air was pretty still. By the same token, I have thrown a round of Trick Catch in Montreal where I made all of my catches (or drops as it were!) about 40 meters from where I threw from due to huge winds. So, if you can say that the Trick Catch is a real boomerang, but slammed

(continued on page 21)

YOUR VOICE

Real change, real soon

by Ed Caldwell

The sport of boomerangs has tremendous potential, but it must be packaged in a way that will create and sustain drama and generate audience interest. One of the ways audience interest can be achieved is to imitate and improve upon measures taken in other sports to successfully capture viewer interest.

Like golf. A tournament scoreboard (leaderboard) that is kept up to the minute, i.e. current, coupled with a running commentary during the course of each competition.

Like world cup yachting. The design aspect of the boat is underscored as an important ingredient in the success or failure of each crew entered in world cup competition.

Like beach volleyball. The strengths and weaknesses of each player (and team) are publicly commented upon and rankings are important.

Like bowling and baseball and football and hockey and soccer. League play and week to week team standings in pursuit of a league championship keep people interested and involved.

Like sponsorships. A prudish avoidance of sponsorships is foolish. If Budweiser sponsors a tournament or a team or a racing car, that does not mean that any of the participants, team members, or cars fuel up on it.

There are a lot of good ideas and suggestions currently circulating among USBA and WBA members that, if implemented, will draw increased public interest. Of course, I assume that the USBA wants boomerangs to become a popular, publicly supported sport, and that the sport is not the restricted domain of a few interested top throwers. Likewise, it ought not be limited to those few persons driven to simply have some fun on a Saturday or Sunday afternoon, nor should it be restricted to a few competitive events scheduled by the USBA every year. The USBA or the USBA in conjunction with WBA, should play an important sponsorship/sanctioning role (like FIFA in soccer, for example) and allow the sport to blossom naturally. As in any activity, (except bull-fighting, perhaps) the more the merrier.

"The sport of boomerangs has tremendous potential, but it must be packaged in a way that will create and sustain drama and generate audience interest."

Another matter that has been bubbling about in my mind for a while now: The USBA should more actively support Kelly Boyer Sagert's book *>Bout Boomerangs: America's Silent Sport*, which we (PLANT*Speak Publications) published. Her book, which the coach of the Australian National team called "a near- perfect portrayal of the sport of boomeranging," deserves the continuing full and active support of USBA and its members. The book could not have been written without the support of USBA members, including some who were not included among those who are so beautifully profiled in the book itself.

We intend to update it with free news supplements (including the 1997 MTA world record and new boomer profiles) through the year 2000. The book will therefore continue to play its natural role as an excellent introduction to the sport and as an endorsement of the USBA. In fact, offered as a premium to every new USBA member, it can be a natural and very appropriate fund raiser for the organization.

OK, enough of my voice (and sales pitch). My overall point is that boomerangs, as both an American and an international sport, should be given the strongest possible USBA support and encouragement. All suggestions for change should be heard by all members and openly commented upon. Finally, reasonable changes which might increase inter-

"...the sport...(can)...capture the public imagination, and become an exciting break from the couch cruiser and computer screen now so sedately occupied by millions of America's youth."

est in the sport must be implemented immediately and aggressively by the USBA. Thus nurtured, the sport cannot but blossom naturally, and begin to capture the public imagination, and become an exciting break from the couch cruiser and computer screen now so sedately occupied by millions of America's youth. Certainly now is the time, if ever, to capture in a public way the glamour and drama of the

sport, especially in conjunction with the World Cup competitions this year and in year 2000, in coordination with the Olympics to be hosted by Sydney, Australia.



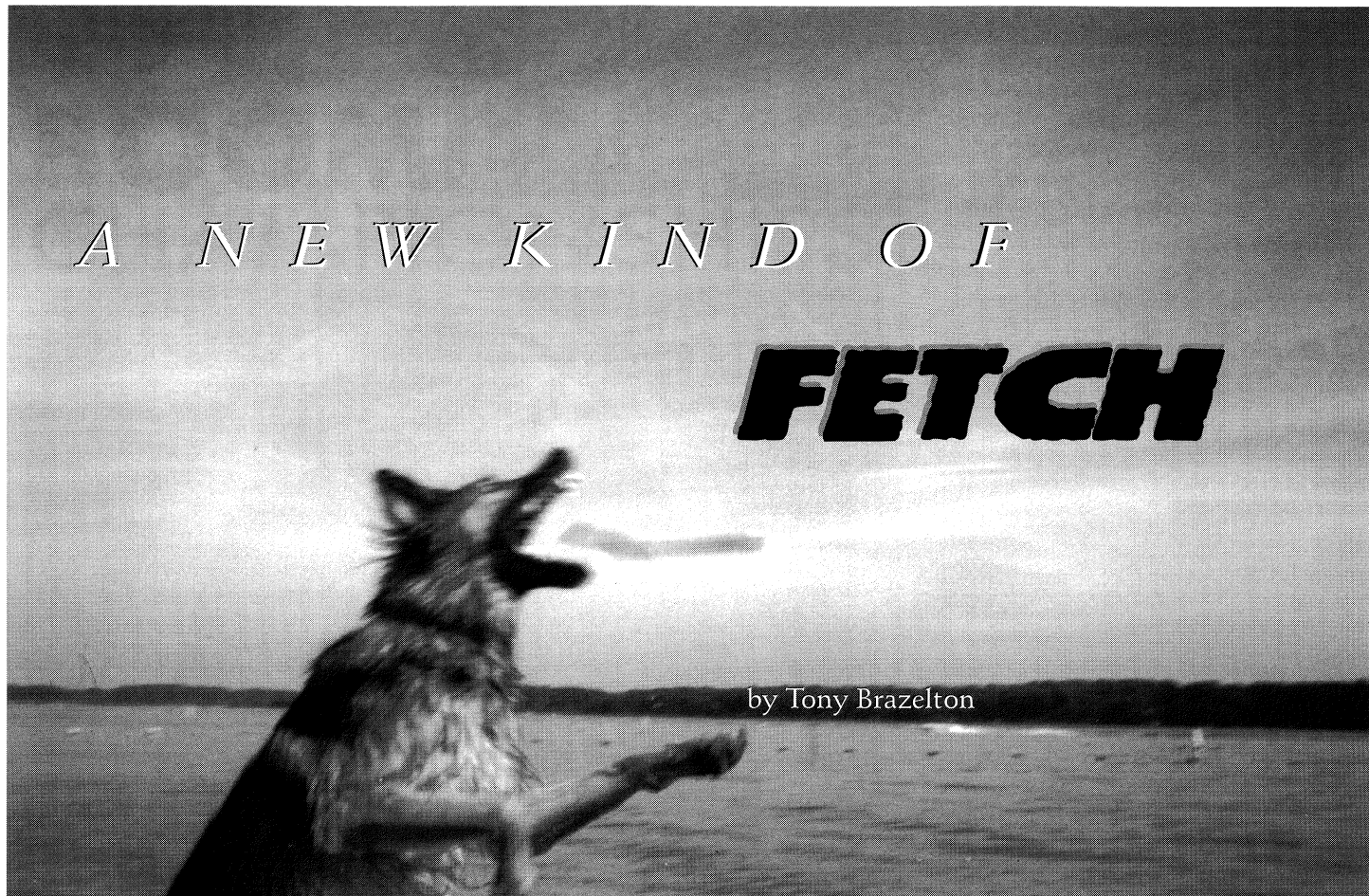

A NEW KIND OF

FETCH

by Tony Brazelton

Although I can't vouch for Nissan's recent claims that dogs love trucks, dogs certainly do love boomerangs. Anyone with a dog and a boomerang knows this. One might argue that

dogs love *anything* they can chase. But a close examination of their behavior reveals that it is much more than that. Booms and dogs just seem to go together. Mike Dickson even named last year's Canton, Ohio tournament the 'Boomdog Open.'

Dogs' instincts to chase are certainly at the root of their passion for boomerangs. My dog Max, for example, loves anything that flies - frisbees, moths and butterflies, footballs - but he gets extra-excited about boomerangs. He works himself into a neurotic frenzy in the moments before the first throw. I have to sneak out of the house if I want to practice alone because he will cry with anxious urgency for hours if he sees me in the park across the street. Human boomers from all over tell the same story.

What follows is a collection of boomdog profiles from across the US.



Boomdogs seem to fall into two categories: boomerang retrievers and boomerang catchers. Most boomerang catchers go through a retrieving phase before their first catch. The boomerang retrievers in this article may well be on their way to catching their first boomerang. If you are the owner of such a dog, read this article to them. Perhaps they will gain inspiration from their catching canine compadres.

Sandy is a boomdog from Sandy, Utah. She loves boomerangs so much that her human, Jim Miller, made Sandy her own boomerang from tooth-friendly polyethylene. "She loves nothing more than to chase after boomerangs until she drops from exhaustion," says Jim. "Her mother was a Border Collie from Idaho where she herded livestock. Sandy has her mother's

instinct to chase down strays and bring them back. I really believe she thinks she plays some role in my boomerangs returning."

Paul Manzi, of Seabrook, New Hampshire had a dog in 1984 named **Dusty** that caught large, two-winged, wooden boomerangs with astounding proficiency.

CANTON BOOMDOG OPEN



Fetch your own stick!

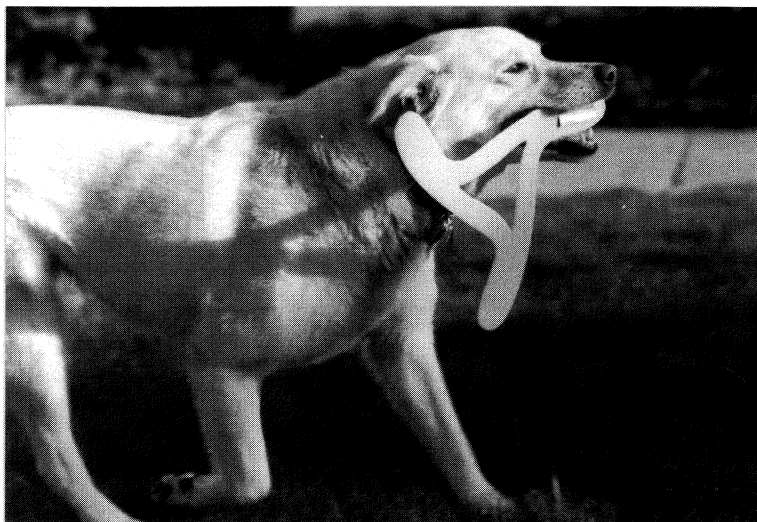

Left: Sandy returns for another throw of her very own polyethylene boomerang.

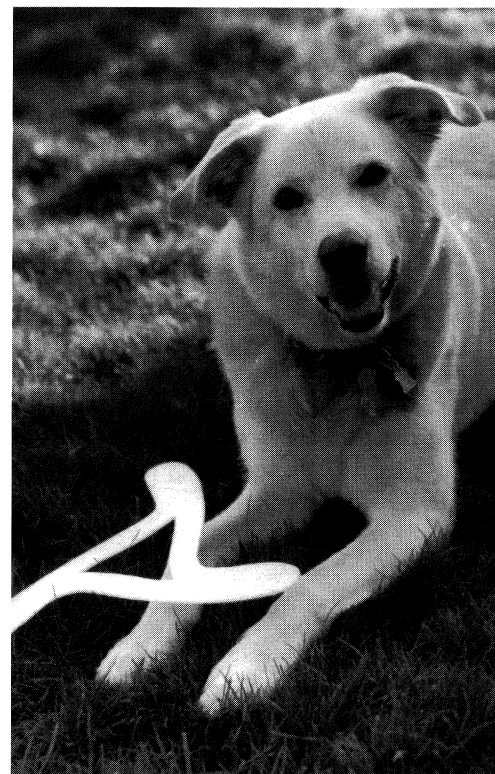

Right: Sandy, proud boomerang owner.

Dogs have a well-developed understanding of aerodynamics. They realize when a boomerang's airfoils are not perfect and apply turbulence-generating indentations between throws to even out the boom's in-flight performance. Many humanoid boomers have noticed that these turbulence generators almost always improve the flight of the boom.

Dogs can get too zealous in their efforts to improve airfoils, however. Ted Bailey of Ann Arbor, Michigan tells how he solved the problem with his boomerang retriever, **Toby**. "Yes, It took practice. All we did was say a lot of No's using a highly authoritarian tone of voice. Then we would ignore Toby until he stopped biting. The first Air Dancer lasted 2 days. The second one 2 weeks. The current one is more than a year old and perfectly intact."

Don 'Spike' Frazier and Craig 'Ditch' Frazier, brothers from St. Charles, Missouri have two

dogs: an Australian Cattle Dog (**Riggs**) and a Stumpy-tailed Cattle Dog (**Ditka**). "Riggs will chase and catch plastic backyarders for as long I can throw them," Spike says.

Boom-crazed herding dogs can be dangerous, though. "Ditka will not chase boomerangs, only ankles as you run after the boom. He has taken my brother clean off his feet with an undercut of his knees," relates Frazier.

Tim Maultsby has two dogs, **Bubbles & Fridge**. Fridge has caught 4 forty meter booms in a row. Fridge likes to shoot two bladed booms in the air with his nose then sometimes catch them too. Once Bubbles was standing behind Fridge. Fridge threw it to her and she caught it. Tim says he is trying to get that on video.

Dogs also understand the need for more than one type of boomerang. Grant Nordwall remarks "When a brand new shape and size

boom comes off the work-bench, my dog is racing around before I've thrown it. How does she know that I'm not making paint stirrers or coat hangers?"

OK, here is where I get to brag about *my* dogs. **Max** is a German Shepherd mix and **Sully** is a pedigreed German Shepherd.

The first outdoor boomerang Max had ever caught (he had caught indoor boomerangs before) was a Fast Catch! Fast Catch booms were always his favorite to watch me practice, probably because of the cool noise they make as



Left: Toby, dropping a Nerf boomerang in front of his photographer.



Right: Jimmy Nunn's dog, Yukon - a Boomerang Retriever from Midwest City, Oklahoma.

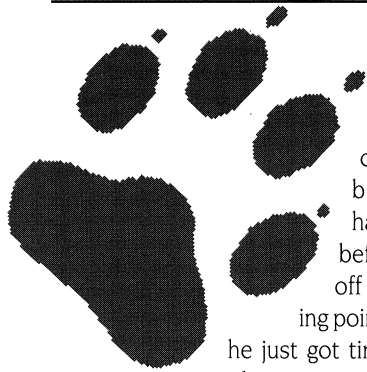

they zip around.

He was chasing every boom about half-way around before cutting it off at its launching point - me. I think

he just got tired of running and just stopped at the top of the circle instead of coming back to me. The next time I threw it he jumped up, knocked it down and came up with a boomerang in his mouth, extremely pleased. I was horrified. I checked his mouth for blood and missing teeth but he was just fine.

I still can't explain how he did it. I expected him to be whimpering in pain, but instead he just looked at me excitedly as if to say, "That was cool! Throw it again!" We immediately went back to the house to get an Air Dancer. Within a few weeks of practice, he was catching nearly every throw. Now he knows the flight of that boom so well that he no longer chases it out and back before catching it. He just stays in a 'ready' position while its in the air and then sprints toward it (if necessary) for dramatic snags. It really looks like he's showing off.

Sully actually catches boomerangs quite well but always relents to Max, the dominant dog. When I take Sully out by himself, he does just as well as Max, and has a very relaxed, Will Gix-



Left: Max goes vertical. Sully chases after.

Right: Max & Sully romp on the beach.



CATS TOO!

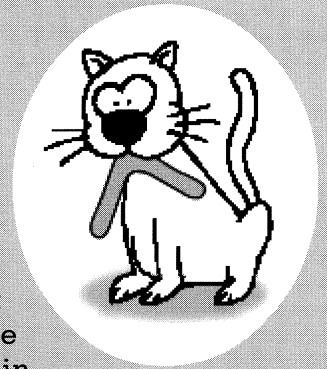

Let's not forget about our other non-human domestic companion, *Felis domesticus*.

Stuart Jones of Minneapolis, Minnesota



has a cat named Boomie who catches indoor rangs with Gellyicious style. Boomie goes totally airborne for rad, stylin' pancakes with Stuart's Roomerang.

Thornton 'Sponge' Alberg of Olympia, Washington sold a woman an indoor boomerang. She later told him that her cat had learned to throw and catch it. Sponge says he is negotiating a film deal with the feline.

Who says only dogs can boom? Any chinchillas out there with a knack for the bent stick?

like, smooth-as-silk style. He doesn't seem to get the same thrill as Max though. I think he only does it because I ask him to.

Although most boomdogs don't have much opportunity to measure their skills against their peers, there is no shortage of expert witnesses. "Toby has experience catching boomerangs thrown by great throwers like Max Hoeben, Roger Perry and Volker Behrens," tells Ted Bailey.

Perhaps it is time for the

USBA to recognize a canine division in competition. Maybe all of us boomdog owners can organize an informal exhibition in St. Louis to make our case. We should probably wait until after the human events are over, however. Boomdogs tend to leave special offerings on the field for the boomgods.



WINTER OF OUR DISCONTENT?

Not with these tips
for sub-zero
boom chuckin'

by Tom Luczycki [8 ^ } >

Winter is usually regarded as a time to make, rather than throw boomerangs, especially for those of us having to endure the northern latitudes. Even with all of its drawbacks, winter throwing has certain qualities that cannot be found in any other season. There is no better windicator than a sky full of snowflakes, and there is never a soccer player to be found. My favorite winter trick is to throw a rang with a low circular path (such as a Colorado Eagle) in a couple of feet of powder, and watch it tiptoe through a portion of its orbit to return without getting bogged down.

Let me stress the words *subzero* (Celsius) in the title. You want the temperature to be below freezing. Any warmer and you will be a miserable wet mess. The real drawback to winter throwing is not the cold, but high winds and limited daylight. Here are a few tips that can make subzero stick chuckin' endurable if not downright enjoyable.



LAYERS

Lots of 'em. My prefs:

1st layer: Polypropylene socks, sweatpants, T-shirt.

2nd: Wool socks, short sweatpants, long sleeve T-shirt or thermal.

3rd: Light waterproof boots, wool sweater (or sweatshirt).

4th: Gaiters (covers the boot and lower pants), Polar fleece pullover.

5th: Windbreaker, anorak, or the brain-tanned pelt of a soccer player.

Headgear should also be layered: Light silk hood/face mask with a brimmed wool hat. I also keep a neoprene ear-cover band in my pocket.

The trick is to shuck the layers as you warm up and BEFORE you

begin to sweat. Learn to pay attention to your warmth. Its easy to get in the groove and become completely soaked, which will result in a quick loss of body heat.

For the most comfort, try mixing your layers. Once I get warmed up, I prefer using just the polar fleece over the T-shirt. If your head gets too warm for any hat at all, the thin head-band will keep your ears from turning black and falling off.

To avoid a chill, don't forget to put layers back on as you progress through the cool-down phase of your workout. With practice, you will find a balance between body temperature, activity and clothing layers.

HANDS

What about the hands, you ask? Leave the gloves at home! Go to your local hunting haberdasher and purchase a hand-warmer and a muff for your hands. Muffs are

usually available in either tasteful camo or day-glo orange. Choose one that you can easily get your hands in and out of, and preferably one with a special interior pocket for a 'Jon-E' hand warmer. If it doesn't have one, sew one in. Believe me, if it falls out and hits the snow its not going to stop until it hits permafrost. Use linen or a similar heat resistant cloth. Don't



use synthetics which generate a lot of static electricity or your last boom-memory will be of making a hasty, crazed snow-angel as flames consume your body. As far as hand-warmers go, I think the lighter fluid models work the best. I have never had any luck with the solid fuel types. The big advantage of a muff is: no matter what layer

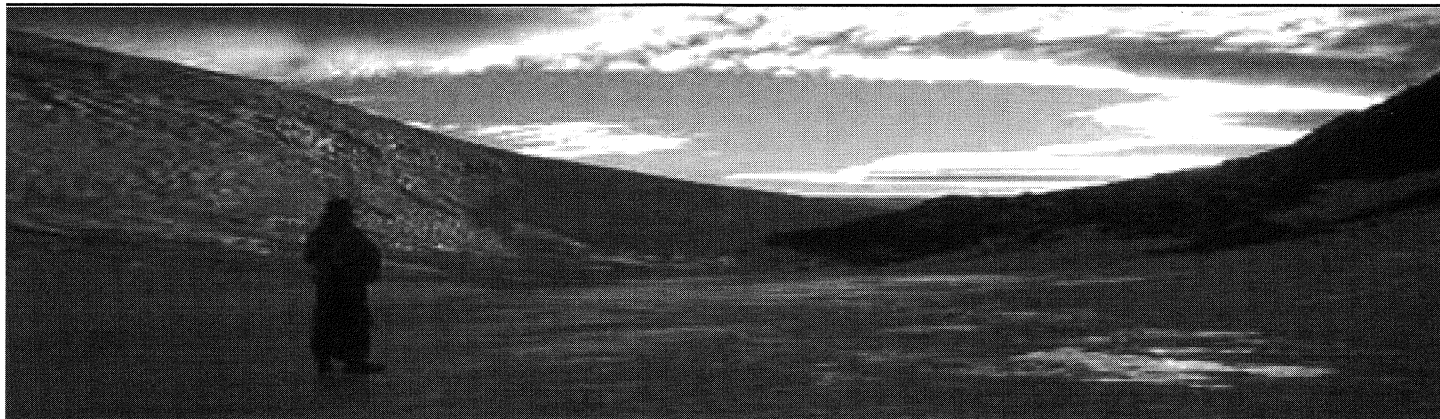

Don't get stuck at sundown, wondering if you have all your booms.

you are wearing on top, you will always have warm pockets for the hands. Throw stick. Put hands in muff. Remove to catch. Though this method may not be appropriate for Fast Catch, after about an hour you will probably no longer need the muff and can take it off. No kidding.

BOOMS

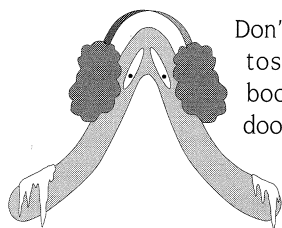

Don't make the mistake of tossing a nice warm boom straight from indoors. In the rare event that you miss a catch (or if you are throwing while it is snow-

ing) the snow will melt then ice up on the rang. Set your boom bag outside for a bit before you go, or keep it in the trunk of your car. (Note: Think twice about trying to tune an ice-cold boomerang. They can be quite brittle.) This will keep both hands and booms ice-free in below freezing temps. If I miss a catch, I pop one end of the rang out of the snow with the snow with my toe, grasp the exposed end, then give the boom a few sharp raps on the side of my boot. If you have acclimatized your boomerangs and the weather is below freezing, this should yield a dry and totally snow-free boom.

Dry booms are the key to dry warm hands, but if they become too dry you will need...

WATER

All available moisture is tied up as a solid at such temperatures, so have a water bottle handy as you will quickly become dehydrated. Dry air makes for dry skin on the hands, which makes it difficult to get a good grip on a rang. This is solved by using a damp chamois cloth to periodically moisten the hands. Think of it like chalking up your cue before a shot in pool. You'll get more power on the throws, and

will make far fewer release-angle errors.

Use just enough to give the proper grip. Any more than that and you'll look like one of those guys left on Everest. Make one end of the chamois wet, then wring out toward the dry end, giving a complete range of moisture.

When completely dry, chamois doesn't take water well; it has to be worked in. Do this before leaving to throw. This is a much more pleasant task in the warmth of your home. Once damp, it will accept water readily from your bottle in the field.

Though there is nothing better than a chamois for drying off a wet boom, and nothing that stinks worse than one left in a boom-bag in a warm dark closet for a few weeks. Make sure to wring it out and let it slowly air dry. Take care of it every time as directed on the package and it will last forever. Screw up just once and you'll have something that even the dog won't play with.



WARM-UP

The cold weather makes it really easy to give yourself a nasty muscle pull! Take your time and ease into the more strenuous throwing.

Suitable throwing weather is scarce this time of year. If it's been a few weeks since your last outing, you will be at a much higher risk for a muscle injury. Warm up slowly!

SHADES

Snowblindness is a sunburn on the retina of the eye. It is identical to welder burn, and is most unpleasant. Symptoms include burning, irritated eyes, and boomerangs hitting you



square in the face. Its always a good idea to wear eye protection (which blocks both boomerangs and UV rays) when tossing, regardless of the weather conditions.

MUSTS

It gets dark mighty quickly in the wintertime, and if you are like me a boom session closes with chanting the mantra, "Just one more throw. Just one more throw." The final sequence involves either getting beaned, or hearing a muffled 'chunk' off in the distance. The ol' torch comes in handy when searching for that errant boom, or packing to go home.

To avoid boomerang loss, I like to count the rangs in my bag before I go out. Its much easier to compare a 'before and after' tally than it is to look at a pile and try to think of what you are missing. However, in Gary Broadbent's case counting could become too tedious. For him I would recommend a weight-based system for comparison. "Hey guys! I'm 12 grams short! Anybody see a Romblad lying around?"



I realize that these suggestions may seem like quite a lot of trouble, but they are not intended for a quick before-dinner toss. The piece of gear you leave behind will be the one you absolutely need. Keep all of your equipment together and you'll be ready to go the second the wind dies down and the sun peaks through the clouds!



70% of everything you need to know about

making boomerangs

Part I

by Fred Malmberg

When *Many Happy Returns* first approached Fred Malmberg about writing a 3500-word article on making boomerangs he said that 3500 words "would be dangerously inadequate, just enough to get you started but not enough to get you from start to finish. I could do 1000 words on inlay techniques alone." But he agreed to do it anyway.

When Fred submitted his final version we asked him to shorten it. He said, "I would much rather the readers get a good 70% overview (which I consider this article to be), than a [3500-word] overview of the topics." We had only one choice. Make it a two-parter.

So, here is Part I of an article on making boomerangs which, remember, is 70% of all you need to know. So when you find yourself sweating just from reading it, just remember: you're only 35% done.

Your Guide to "70% of everything you need to know: Part I"

Part One will cover the different **materials** used to make boomerangs, **tools**, and techniques for **making plywood boomerangs**. Part Two in the next issue (#72, Spring 1998) will cover how to modify Darnell TriFly blanks, painting & sealing, tuning, and advanced techniques such as lapjoints, strip laminates, and inlays.

The first part of each section will cover the basics of that topic, assuming no prior knowledge of boomerang building at all. This is for the benefit of those new to boomerangs, new to construction of them, new to a certain type of construction, or simply those with a passing interest in knowing how it is done.

Within some sections will be an 'Advanced Tips' box, which will help boomsmiths who have mastered the basics to complete the task faster, more refined, better, or at least with a deeper understanding of it.

So fire up the jigsaw & drum sander or dust off your coping saw & rasp and get ready to crank out the best booms you've ever made.

PART I

I. Materials used to make booms

II. Hand and power tools

III. How to make plywood and phenolic boomerangs

PART II

IV. Plastic TriFly modified boomerangs

V. Painting and sealing

VI. Tuning

VII. Lap joints and strip-laminates

VIII. Inlays

Materials Used to Make Boomerangs

Plywood is the material I suggest you use for making your first boomerang. It is the easiest to work with, can be adjusted pretty easily, and can be finished in a vast multitude of ways. You want plywood that is 4 to 7 mm (3/16" to 9/32") thick, although I have seen boomerangs both thicker than this (typically long distance models, unless the plywood is less dense than most) and thinner than this (typically used for MTA events, a high-flying, long-floating boomerang). What you need is at least 5 plies (layers of wood in plywood are called "plies") in whatever thickness you buy; less than 5 and you risk having too flexible a boomerang. This multi-ply, relatively thin plywood is sold as "Baltic birch" or "Finnish birch" (as in Finland) plywood. Perhaps an ideal layer and thickness plywood would be 10-12 layer 5 mm or 6 mm plywood for a two-blader, and 4 mm for a three-blader. Most German Fast Catch tribladers are not made of 4mm plywood, at least the ones I've seen sold here, and do not fly as well as their 4mm duplicates. While these sizes are not written in stone, your best bets lie with these

sizes.

Competition rangs also include plastics. Since my adventures into the non-Tri-fly plastics realm can be described as mostly experimental, I contacted that bastion of boomerang info, Gary Broadbent, for his input on plastics. That word again was bastion. Sheet material includes polypropylene (probably want 3/16"), ABS (either 3/16" or 1/4"), Lexan polycarbonate (3/16" or 1/4", although excellent non-returns can be made from 3/8" and 1/2"), PVC, ultra-high molecular weight polyethylene, and other lesser known plastics. Advanced tip - some of these lesser known plastics may be a place to adventure to find something that no one else has yet tried. Plastics tend to be heavier than plywood, and because they are denser, require a thinner cross section of airfoil (thinner material to start with).

Plastics also include pre-fabricated models, including Darnell's unbelievably modified Tri-fly models in all their forms (poly to ABS to Lexan). I will cover these modifications later, in a separate section.

Phenolics is the last of the typical materials used in boomerang construction. Different companies have differing names for this material: "Paxolin", "Bakelite", and "Micarta" are often seen. Phenolics come in three types, based on the substrate used in the construction of the material. Phenolics are either paper, canvas, or linen. 1/16" paper is used for MTA construction; 3/32" is used for doublers; 1/8" or especially 3/16" linen is used for Aussie round rangs. Another item used recently is something called "G-10". It is a glass epoxy resin, using fiberglass as its substrate. There is a whole series of "G" materials, from "G-1" to G-11". 3/32" is good for 30-40m booms, 1/8" often used in Aussie round booms, and 3/16" for four-bladed Aussie round beasts. Not for the faint of heart, or first time boom makers.

Hand and Power Tools Useful (or necessary) in Boomerang Construction

You will need an area large enough to move your plywood around in, and something to rest it on. I suggest a sawhorse. I used that for years; I now use something I call a frame I bought at an auction, that is kind of 'U'-shaped and hollow (top view), and the top is slightly angled

(side view) so I can stand inside it and cut the pieces out, and have the piece comfortably tilted. In any event, have something you can cut the wood on, and have it the right height, or your back will let you know that it's wrong.

Next, you need a pattern, or template, of the boomerang you are going to make. I will cover this later; I don't consider it a tool.

After the shape is laid out on the plywood, you need some way of cutting it out. If it is close enough to the edge of the plywood, you can use a hand-held fret saw, or coping saw. This having been said, if you try it once, you'll never do it again. Too much like work, too much wasted plywood.

Beg, borrow, or rent an electric hand-held jigsaw. They reciprocate (move the blade up and down) like your hand would have been doing had you used a hand-held saw. Except now, all you have to do is hold a trigger down (and most better ones have a second "hold" button, so all you have to do now is guide it). Use one just one time and you'll never use anything else. I used a cheap Black and Decker model for years; now I use a Porter Cable model. If yours has an option to use an orbital cutting method (only found on more expensive models), I suggest little to no orbital action. It speeds the cutting, at the expense of more tearout.

Once cut out, the flat unformed boomerang approaches what I call a "blank"; all it needs is the final edge to be smoothed. I use a 1/4 horsepower motor attached to a 3" long by 3" diameter hard rubber drum, and call this my rotary grinder or sander. It does the final edge and the airfoils on all my boomerangs, and helps me finalize the lap joint and the thickness of the rest of the surface of the rare wood booms I make. I consider it to be the real workhorse of the whole process, and most of the final artistic interpretation can be done at this machine.

Orbital sanders are the next sanders I use, except on the exotic (rare) wood models. They are also usually the final sanders I use on my plywood models. Get a good quality model; I highly suggest the Porter Cable model 330 for this. It has been around for years. Kids in schools in Vo-Tech often drop these bears down the steps (accidentally, of course) and they usually can be plugged in and work beautifully. When using them, be careful to not move too quickly, or else unsightly 'figure-8' scratches will occur, especially in the coarser grit sandpapers. I do not use these sanders in rare wood models, because of these scratches; they can take forever to get out. Chet Snouffer once said, in his old newsletter, that builders either love

these sanders, or hate them. I don't believe he was a fan of them, but for plywood models, I definitely am. Almost anything these do, hand sanding can do, but it will take a lot longer to do by hand.

On rare wood models, I do use a random orbital sander. This sander moves in a completely different pattern than the orbital sander, although their names seem pretty similar. I find their use is pretty much different from the orbital sanders, though. It constantly takes off the highest point on whatever it is placed; it eventually flattens out any irregularity in a piece of wood. For a rare wood model, with many pits and high points, left over from sawing the individual pieces out, this tool is an absolute god-send. If you do my type of rare wood boomerang construction, this is one of the four tools absolutely necessary (along with the bandsaw, the rotary sander, and the router table). It is not necessary with plywood, plastics, or phenolics construction, and is even more difficult to use than the orbital sander, at least initially. It makes a weird kind of gyroscopic sensation, like you are wrestling a barbiturate-drugged weasel with a handle.

Routers and router tables are the next tools. Most people will not need these; I use them in rare wood lap joints, and some use them in faster, high-quantity construction methods. I have seen some who finalize the edge with routers following patterns, and others who put leading or trailing edges on booms with routers. These are techniques I won't go into here, except for the lap joints, which will come later.

Next is the bandsaw. Again, I only use this in rare wood lap joint construction, and there I find it indispensable. In routine boom construction, you won't need it. Some use this to cut out multiple layers of plywood, with the pattern drawn on the top layer, and then separate the layers later (often held together with double-sided tape). I often found that the column of the bandsaw gets in the way, and my bandsaw column side is too close to a wall to use this way in any event. I think most beginners, and most advanced makers, will find the jigsaw is much easier to use for a moderate boomerang production. Make sure you use one with a deep throat; Gary suggests a minimum of 16", and mine is 18" (and my bandsaw's big, too). The extra depth will come in handy.

The next tools may come in handy, especially in that internal part of the elbow that no other tool seems to be able to reach. The smallest tool that works at all is called a Dremel tool. If you are going to make only about 5 boomerangs or so a year, this tool will do just fine (or

some of the others coming on the market, similar in size). You can find accessories for this tool everywhere, including Wal-mart. I find the most useful part of this tool, with a router-type base on it, is for creating the hole in the boom for the piece you wish to inlay. Next in price, but way up in power, is something called an industrial die grinder. Very powerful, unbelievably noisy, drop it on your foot once and earn the name "Gimpy" for life. I use a "hairy" carbide tooth bit in mine, which is about 1/2" wide. This tool almost scares me, and chain saws don't scare me too much. I don't use it often. My favorite for this area costs more, but is worth finding, even if you have to look for a used one. A Foredom tool is a motor with a flexible shaft coming out of it, a handpiece, in which you change bits, not unlike a more powerful Dremel. Much nicer, 5 times the power of a Dremel, and just a more comfortable tool to use.

Finally, the dust collector. Use it. Minimally, use it on your major grinding tool (for me, the rotary sander), as this is where you produce the most dust capable of killing you. Bandsaws and jigsaws typically produce larger dust particles, whereas sanders create that dust that flies and lingers. If you make more than one boomerang a month, and do not use a dust collector, please do not read the rest of these instructions. If you make any rare wood models, you must use it. And, a vacuum cleaner is not a dust collector. Dust collectors stand 5-6ft. high, with at least one (preferably two) large, usually white material bags that filter the dust out of the air. One costs maybe \$200, and is the only tool you may ever buy that can be proven to save your health, and possibly your life. Dust protection, eye protection, ear protection, and hand protection are subjects I won't argue about; they shouldn't have to be argued about.

How to Make Plywood and Phenolic Boomerangs

To actually make the boomerang, the first thing you need is a pattern to follow, or what I call a template. A template is an actual, physical rendering of the 2-dimensional shape (like when you see a boom hanging on a wall; this is the 2-D shape) of the boom blank itself. It can be made of almost anything; I use posterboard.

If you are going to be using these many, many times, then you might want something more substantial (edges of posterboard eventually bend over), such as 1/8" pressboard, which is like flexible plywood made of something more like cardboard. I also use templates in making rare wood models, but will discuss those separately at that time. Pattern/template advantages are that a decent boom is capable of being reproduced over and over; changes can be made by making a new template, and basically copying the original except for the factor you want changed. Eventually, you can get a boomerang template that will produce boomerangs that fly well, and can be easily reproduced. I believe that MHR will be carrying more reproducible boom patterns in the near future, and suggest that those out there who can supply such patterns to please submit them. Patterns are even available for free on the Internet. All you have to do is blow them up to the correct size. If all else fails, for your first boom anyway, copy one you have that you know flies well. This will give you excellent practice, and you can tell from the original what else needs to be done.

Lay the template on the plywood (or plastic sheet or Paxolin, if that is what you are using), and trace around it with a pencil (or thin marker on the plastics/phenolics). You now have the pattern transferred to the material, and all you have to do is cut it out. I hope you begged, borrowed, or rented a hand-held electric jigsaw, because now is when we need it. There are many blades available for the jigsaw; you want one that puts at least three teeth in the wood at a time. This is a minimum of 12 teeth per inch for 1/4" plywood, and more teeth per inch for 4 mm or 5 mm. I suggest a 15-20 tpi (teeth per inch) blade that is fairly thin from the teeth to the back of the blade; this makes cutting around corners a little easier. Plastics can usually be cut with the same blades used for plywood, and phenolics can be cut with special blades. Gary told me that Porter Cable makes one that looks like a miniature rasp, made of tungsten graphite, that works pretty well. I was cutting a phenolic blank out on my back porch one day, and noticed how difficult it was to cut them out. After I finished, I noticed I had actually touched the edge of the porch with the blade (under the sheet, invisible to me at the time), and cut into a little. What is a little more amazing is that the porch is made of cement!

In cutting out plywood models, you are going to get a little "tearout". Tearout is where some of the top or bottom layers of wood "fray" somewhat, and if it is too long, you just grind this off in the next step. If the fraying tears out

the wrong way, and a small piece chips off of your pattern line, then there is a problem, although usually a correctable one. You are going to be rounding off or beveling the edge all the way around, so a small chip won't even be seen on the final product. The wood there would have been rounded off or beveled off anyway. However, it does force you to use this surface as the top surface, which is usually not a problem. I tend to cut plywood about 1/8" extra wide of the pattern, and most tearout is found in that first 1/8". I have little trouble with tearout. Plastics and phenolics, I cut as close as possible, as tearout is not a problem, at least with the ones I have tried. Any extra you leave here has to be removed in the next step anyway, so do as much as you can here.

The next step is pretty easy, and usually fun,
(continued on page 20)

Advanced TIP

Ted Bailey relayed this one to me once. He said if you start having problems with too much tearout, he suspected it was because only the two outermost layers dried out too much. He suggested that if you put water in one of plant sprayer bottles such as your local K-mart would sell, and lightly spritz the plywood all over, not to the point of puddling of water, just moisten it, both sides, and let it sit for 15 minutes, then cut your patterns out, there will be less tearout. I never tried it; just cut 1/8" proud of the pattern, and grind off the excess in the next step. I also believe the tearout is more likely due to the fact that there is no support on the upper and lower-most plies, they have a "degree of freedom" the other plies don't have (surrounded top and bottom by other plies), so when the slightly angled sawtooth hits it, it has an oblique torque, and levers up as a result. I do agree only the outermost plies should have trouble with drying out too much, and if you are having trouble with tearout, give it a try.

Rusty Harding's E-Rang

Use

Fun! Mesmerize yourself and others with the E-Rang's 'floating dot' illusion.

Range

30 meters

Wind

Calm to moderate wind

Material

Rusty makes his from 5 mm, 7-ply.

Carving

Cut and shape airfoils as shown. Add moderate undercut to underside of leading edges as shown by dotted lines.

Throwing

Fairly laid out and just above the horizon.
Easy toss.

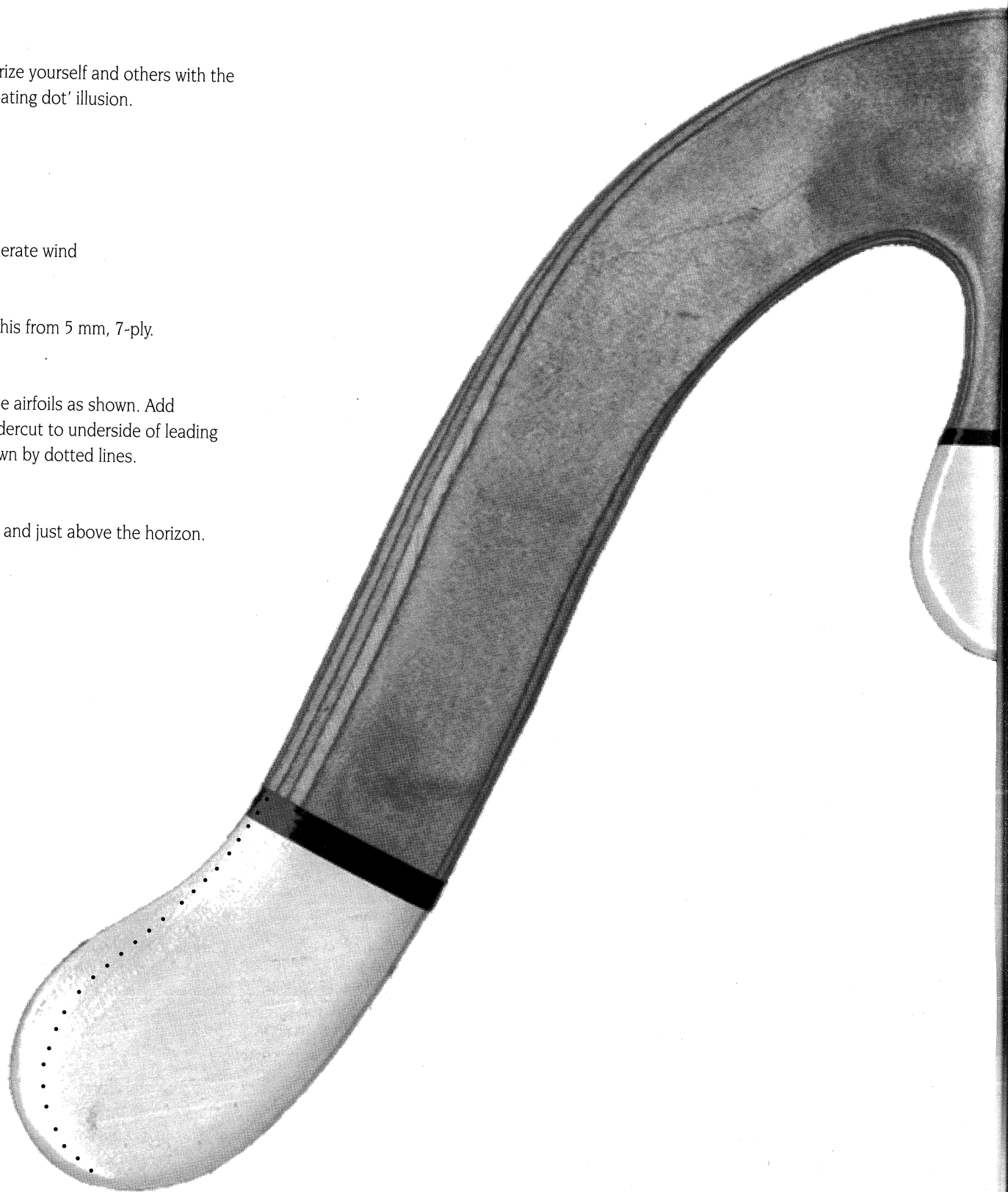

Scale

1:1



Gerhard Bertling's Triton IV

Reprinted with permission from the *BBS Journal*
Translation from French by Tony Brazelton

Scale
1:1.41

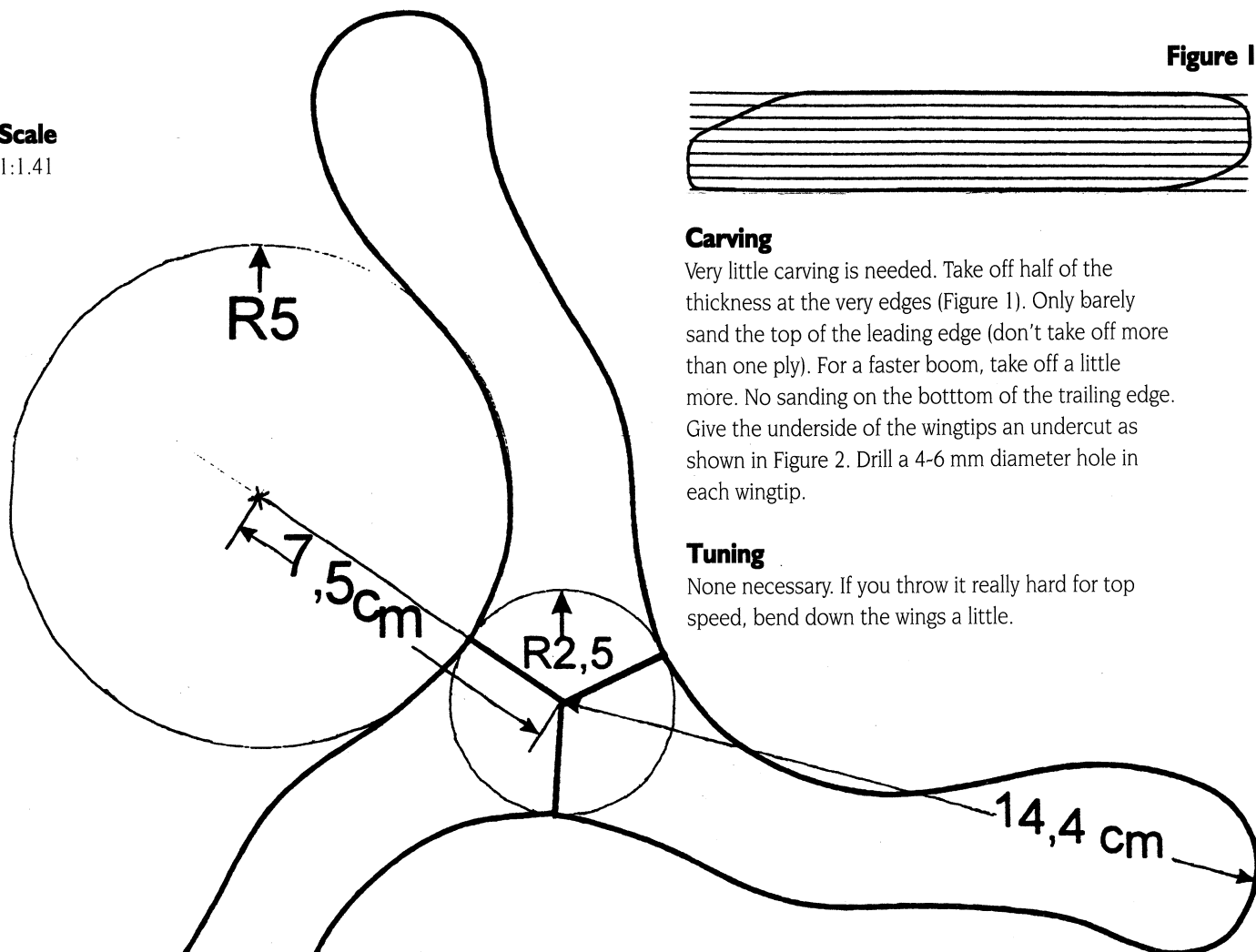

Figure 1



Carving

Very little carving is needed. Take off half of the thickness at the very edges (Figure 1). Only barely sand the top of the leading edge (don't take off more than one ply). For a faster boom, take off a little more. No sanding on the bottom of the trailing edge. Give the underside of the wingtips an undercut as shown in Figure 2. Drill a 4-6 mm diameter hole in each wingtip.

Tuning

None necessary. If you throw it really hard for top speed, bend down the wings a little.

Use

Sub-20 Fast Catch and Endurance

Range

20 meters

Wind

Calm to light wind

Material

4 mm, 8-ply aircraft-grade Finland birch plywood

Weight

40 g after sealing

Throwing

Nearly vertical. Aim just above the horizon. Lots of spin! Times under 20 seconds are possible with a hard throw.

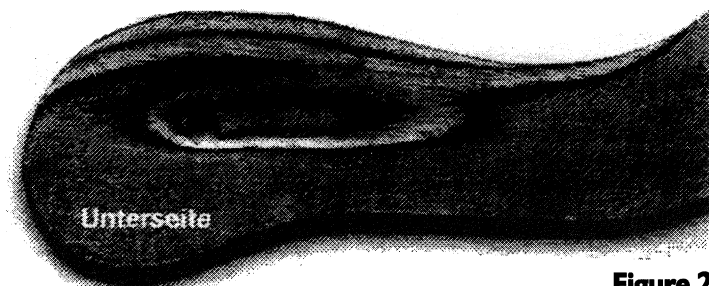
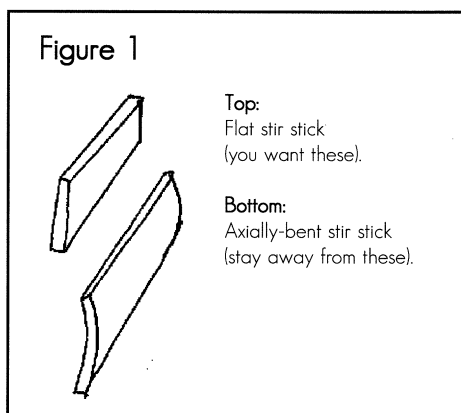

Figure 2

Paint Stir Stick Boom

by Fred Malmberg

1. Buy two paint stir sticks from a local paint or hardware store. Try to find two that are fairly flat. Most of these are slightly bent axially, that is, shaped like the bark on a tree (figure 1). I use the flattest sticks available.



2. Cross one stick over the other and see how they fit together. Try to get two that fit with minimal gaps in between the sticks (figure 2). You can cross them neatly in the center, or slightly offset one, like a 'T.' The first flies a little better, the second looks neat. The angle of intersection should be near 90 degrees. Keep the concave side of the sticks facing down. Mark the intersection points on both sticks with a pencil.

3. Use epoxy to glue the two sticks together. I use Duro brand two-part epoxy. It's the slow-dry type which forms a better bond than the fast-dry stuff. Put the epoxy on BOTH sticks between the pencil lines and then put the sticks together. Hold them in place for 24 hours with a spring clamp or C-clamp. After it dries, remove the clamp. I don't grind off the extra glue squeezed out by the clamp, as it adds some reinforcement.

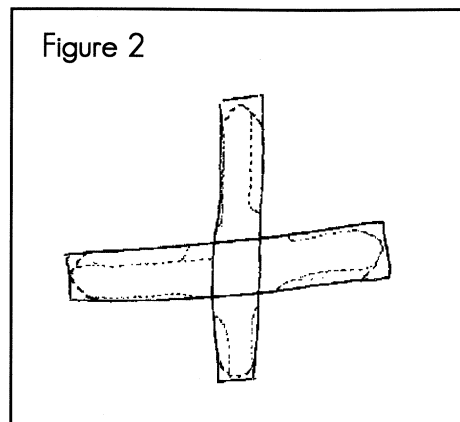

4. Now the wings need to be shaped slightly. Round off the end of each wingtip to remove any sharp corners (figure 2). You can use any bench grinder, sanding drum, disk, or even paper and elbow grease to do this. Now add airfoil. First, determine whether you are making a right- or left-handed model. The edge of the wing that cuts

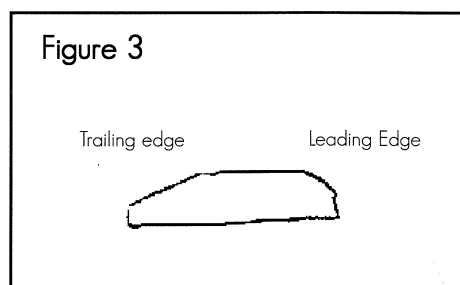

through the air first is called the leading edge, and the upper surface of this edge is rounded off, except for the inch nearest the joint of the two crossed sticks. Do not make the trailing edge too thin; at least 1/3 of the thickness of the wing should remain at the bottom of the trailing edge after you finish beveling (figure 3). Slight hand sanding may be required to smooth the wood.

5. Test drive the boomerang. If it flies well, it needs no tuning. If however, it crashes into the ground or goes too far to return when thrown properly, one or more of the wings is probably bent downwards. If it flies too high, swooping up then crashing down, then one or more of the wings is probably bent upwards. If it flies a very short circle (five yards) or runs out of spin at the end of the flight, the wingtips have too much positive angle of attack (the wing is twisted such that the leading edge is higher than the trailing edge). If it crashes to the ground far away or even turns the wrong direction, the wingtips may have too much negative angle of attack (the leading edge is lower than the trailing edge).

These tuning problems can all be fixed by using a microwave oven. Put the boomerang in for 15 seconds, then remove and bend the involved wings into a definite overcorrected position (you may need a towel or oven mitts to handle the hot boom). Too much strain will break the sticks, but if done correctly the sticks will spring back somewhat, attaining a new bend, hopefully the correct amount. Do not go over 15 seconds or the wood may burn. Several corrections are possible on just one heating.

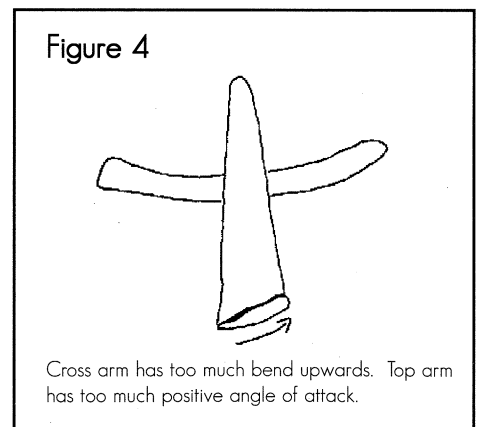

Our Silent Sport just got louder

by Tara Hemami

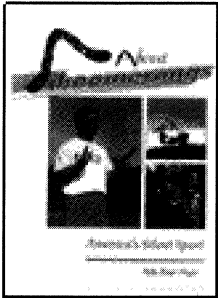

About Boomerangs: America's Silent Sport
Kelly Boyer Sagert
(PLANT*Speak Publications, US\$24.95)

If during these cold winter months you are finding it hard to motivate yourself to go out and throw boomerangs, take some inspiration from Kelly Boyer Sagert's book. It is a snapshot of the current state of boomerangs in America.

The highlight of *About Boomerangs* is profiles of 16 boomerang competitors, including Chet Snouffer, Ted Bailey, Adam Ruhf, Barnaby Ruhe, and Eric Darnell. Sagert gives a history of the accomplishments, high points, and low points, of these boomeranger's careers. But more importantly, she captures the excitement and motivation each thrower has for the sport. Whether it is the competition, technology, or just plain fascination with boomerang flight, Sagert illustrates the uniqueness of each thrower's motivation to excel in the sport.

About Boomerangs is written as a series of short articles and is best read by picking out the section that one finds most intriguing at the time rather than reading it from cover to cover. These articles include the history of boomerangs, debunkings of the myth that boomerangs are weapons, an excellent discussion

“Boomerang throwers pose an interesting paradox; while they are a friendly group of people, they also seem to each have a highly individual mindset, eager to forge his or her own way in the sport.”

- Kelly Boyer Sagert
About Boomerangs

on why boomerangs return, and profiles of six boomerang artists including Jonas Romblad and Fred Malmberg.

Sagert completes her discussion about boomerang personalities with sections on women in boomerangs featuring Betsylew Miale-Gix, international boomerang players, and profiles of a typical player (conclusion: "...boom throwers are a wonderful tossed salad set of characters...")

Finally, Sagert wrote a brief explanation of the USBA tournament events and the last section includes an introduction to resources like boomerang newsletters, organizations, clubs, and internet sites.

The book is an excellent introduction for someone who knows nothing about boomerangs. However, the book has one drawback for this audience. Sagert's explanation of how to throw a boomerang is somewhat cumbersome and novices would do better getting their throwing tips from manufacturers' literature.

About Boomerangs is a must for any complete boomerang collection and makes an excellent gift for a novice, with a boomerang of course.

MISCELLANEOUS

New hope for shop mistakes

by Fred Malmberg

Question: What do you do when you've ground away too much material from your last Darnell ABS blank? Call Gary Broadbent and get some more from the last known storehouse of blanks? No. You save the day by replacing some of the stuff you ground off! You can do it with *Formula 27*, by Evercoat.

You mix up a putty-like substance with a liquid hardener in a ratio of 20 to one. You get about five minutes to work with it before it becomes too stiff. If you add too much hardener, you'll get even less working time.

It hardens fully in about two hours and can be sanded just like wood. In its hardened state your fingernail cannot leave a mark on it, which makes it harder than most woods. It hardens to a whitish-gray color, which can be painted.

I like this stuff. You can find it at most hardware stores near the wood fillers and putties. *Formula 27* can be used on *any* material (plywood, plastic, phenolic - anything). But if you try to use this stuff on a rare wood boom, I will find you. I will.

REPORTS

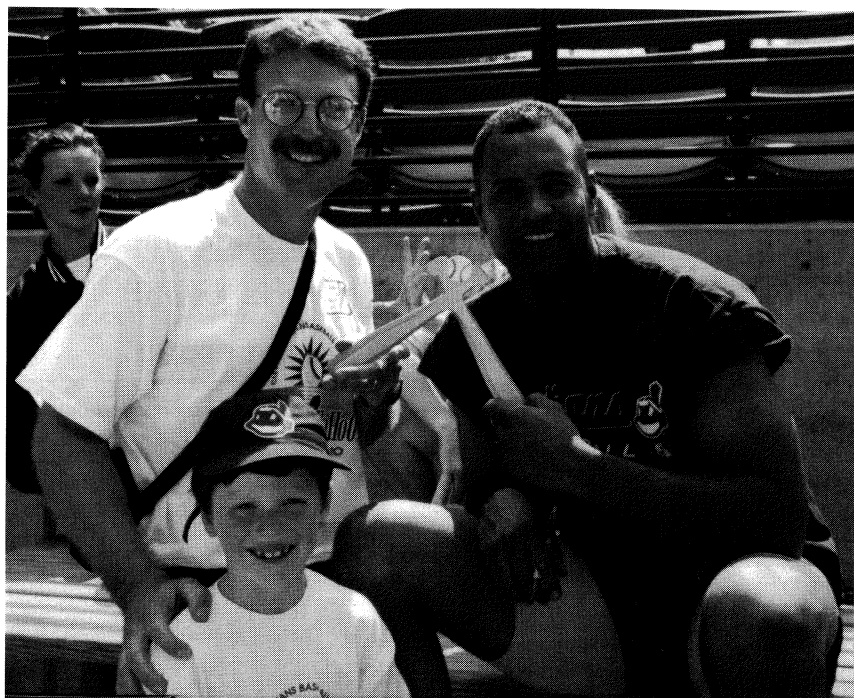

"This fulfilled a fantasy I'd been nursing for a week - throwing a boom on the pristine turf of the Jacobs Field outfield!"

- Mike Dickson

Mike Dickson teaches Indians to boom

Last Summer, Mike Dickson and son Adam of Canton, Ohio introduced major leaguers Sandy Alomar, Jr. and Omar Vizquel to our sport. Mike's account follows:

Adam and I attended a Father/Son day camp held on Jacobs Field, home of the Cleveland Indians. All the Indians coaches held short clinics and we went out on the field, in the dugout, locker room and training room. Adam took pitches in the batting cages and visited the press box. Very cool.

I was prepared. I had made a few baseball bat booms (two crossed bats with a ball on top) out of 4 mm and 5 mm Finland Birch to present to Sandy Alomar, Jr., catcher for the Indians and the MVP of this year's All-Star Game, and Omar

Vizquel, the Indians shortstop. Sandy said, "Yeah, I'll probably hit myself in the head with it." When I asked Omar if I could demonstrate it for him, he went on at length how he imagined it would bounce off the seats and come back. I gave them full instructions - hopefully they'll check them out in the off season. We know they have the arms!

I also presented one to Rick Manning, the broadcaster for the Tribe when we were in left field. I asked if I could demonstrate it for him and he said "Sure." This fulfilled a fantasy I'd been nursing for a week - throwing a boom on the pristine turf of the Jacobs Field outfield! It was pouring down rain at the time, and the group we were with was watching from inside a

garage door on the warning track (except Adam and a few other boys who were pretending they were jumping up the 325 ft wall making leaping catches).

I checked the wind (the only flag was way up above the Jumbotron). It was about 6-8 mph. The baseball bat boom is sort of like a little Aussie, gets about 30 meters, lays out a little, goes a bit past you, and then drifts in for the catch. The first throw hit the left field 19 ft wall. Then, of course, I knew to throw more right, and it sailed down for an easy catch. Everyone clapped and my day was made! Adam had an awesome time too!



Lag B'Omer 1997

by Dave Hendricks

Here is a great opportunity for others to do a boomerang demo for very interested parties. Back in early spring we were contacted by Rabbi Hersen of Basking Ridge, N. J. about the possibility of doing a boomerang demo. This would be held on Sunday, May 25th at 4 PM in conjunction with the Jewish holiday of Lag B'Omer. Lag B'Omer is 33 days after Passover. It is customary for many Jews to celebrate this holiday with an outdoor event, often at picnics. They usually try to feature a demonstration of something that flies (kites are the normal choice).

Recently it was suggested that boomerangs would make for an interesting demo and would also fit in with the name of the holiday. We were then contacted by Rabbi Bresinger of West Orange, N.J. about doing the same thing for their event to be held at 11:30 AM the same day.

We arranged to come and show boomerangs and how to throw them. In many ways this was like a "Toss Across America" event (held the day before). We did not charge to do this but both rabbis arranged for us to get lunch or dinner at the event and we were allowed (encouraged) to sell boomerangs.

We arrived at West Orange at 11:00 during rain storm which lasted until after dark. Because we had promised to make an appearance, we figured on making the best of it and Rabbi Bresinger was pleased. I headed onto the field to test the conditions for throwing. Although it was then only raining lightly, there were none of the high winds that plagued the northeast for weeks and throwing was not all that bad.

Plastic boomerangs were the rule for the day. I make some small tribladers from an 1/8 inch thick material called Trovicel which were light enough for most throwers and still held up in the rain. Some of the other plastic boomerangs that were used included Eric Darnell's Tri-Flys & ProFlys, Barnaby Ruhe's Boomerang Fe-

ver, Gregg Snouffer's Tantrum and a few designs made by Mike Barrett from 3/16 polypropylene. After several practice throws some of the attendees rushed onto the field to learn to throw. No time to do a demo now, let's just get some booms in their hands and keep them happy.

My wife Barb worked with some of the younger throwers and I got the older ones. Things got a little crazy at times with too many throwers tossing at once from different areas of the field. Several booms got stuck in trees but a spare softball or soccer ball took care of that (note: do not stand under the wet tree when throwing a soccer ball at the branches). After getting moderately wet we headed into the picnic pavilion for lunch. They had the best garlic dill pickles around and the burgers were great.

After lunch more people had arrived and wanted to see boomerangs so we returned to the field. At this point many of us were too wet

**"The group was amazed!
'Boomerangs really work!'"**

to care any more and just kept throwing. Barb stayed under the pavilion and set up a table with boomerangs for sale. Finally we gave up on the weather and returned to the pavilion only to find out that Bart Lidofsky from New York City had showed up to help. We packed it up and headed to our next location after being told that we were good sports for driving 1.5 hours and throwing in the rain.

We arrived in Basking Ridge about 3:30 only to see Rabbi Hersen setting up for their picnic. The park was terrific with several large fields near and a small open area next to the picnic pavilion so that short range demos were possible for everyone to see. We set up our table and answered many questions about boomerangs before dinner. The smoked beef brisket was especially delicious.

After dinner and a short talk about Lag B'Omer by Rabbi Bresinger (yes he was there

"Both rabbis put an effort into promoting the event in their area through flyers and announcements, calling the event 'Lag Boomerang'..."

too) we were introduced. I gave a 5-10 minute talk on boomerangs and the USBA and then stepped out of the pavilion for a few demo throws. The group was amazed! "Boomerangs really work!" With this action Barb was overwhelmed with people wanting boomerangs. Several wanted to see some longer range throws or wanted to test their new booms so I headed to the large field with Bart to do some serious throwing.

The rain, which had only one hour earlier been heavy, had now slowed to a mist. We had a ball for about 30 minutes as the group tried various boomerangs. Then we headed back to the main group, who had by this time overwhelmed Barb with business and questions.

Because of the fun had by all at both locations we will probably be invited back. In fact, Rabbi Hersen's wife is recommending us to her brother for next year in Cherry Hill, N.J.

I would like to recommend that others take the chance and contact rabbis in their area about doing such a demo. I understand that Stuart Jones of Minneapolis and Mike Gabriel of Evanston, Illinois did similar events in their respective regions.

It was fun and the group was a captive and receptive audience. Both Rabbis put an effort into promoting the event in their area through flyers and announcements, calling the event "Lag Boomerang," which everyone thought was especially funny. Everyone, including the rabbis, seemed to be interested in the boomerangs and most people wanted to try to throw. Both Rabbi Hersen's and Rabbi Bresinger's wives

(continued on page 21)



Commemorative plaque to support 1998 World Championship

John Cryderman of Chatham, Ontario is currently building a large wooden plaque commemorating the World Boomerang Championships as a fund raiser.

The plaque has room for approximately 150 names of competitors and their state or country. The top of the plaque has a Herb Smith Sussex Hook attached and wooden letters spelling out "The 1998 World Boomerang

Championship Supporters".

Cryderman has been marketing a 40-page boom catalogue for the past several months. One dollar from the revenue of each sale goes to supporting next year's games. Everyone that purchases a catalogue will automatically have their name and state or country embossed on the plaque. This huge one meter by one and one half meter plaque will then be auctioned

at the world championships and the money raised will go back into the cost of hosting the games.

There are currently 65 names that I have to date on the plaque. Persons wishing to purchase Cryderman's catalog and support the 1998 World Boomerang Championship can find Cryderman's USBA Member Boomsmiths and Retailers listing on page 22.

M. H. Archives

The who, what, when, where, and how of yesteryear

10 years ago

"On October 28, 1987, the airwaves were blessed with a Paul Harvey commentary on the boomerang movement within the USA.

"Some of the information was outdated as he related the USA win over Australia in the 1981 test series and the MTA world record by Dr. Larry Ruhf. There was no mention of the Aussie win over the USA in 1984 or of Dennis Joyce's new MTA world record.

"The most unusual thing about the commentary was that it was entirely positive advertisement for the sport we all so dearly love and for that we must give him our thanks."

MHR #33 WINTER 1988

5 years ago

"The 1993 World Cup, originally scheduled to take place in Chatham, Ontario, Canada on April 19-25 has been officially cancelled.

"The reason for the cancellation was a last minute bureaucratic nightmare when a Kent County official blocked the use of the field that was to be used for competition. This was in spite of strong support for the championship by both city and federal government officials.

"...the time required to make (another) field available would not guarantee a competition site by April 19. And it is for this reason that the competition had to be cancelled."

MHR #53 WINTER 1992



Girvin closes Gel Boomerangs

Gel Boomerangs is going out of business - permanently.

Just after the Fall issue (#70) of MHR went to press, Michael 'Gel' Girvin announced that his company will sell its current stock and then close its doors forever.

Girvin said had to close the business as a direct result of the same health problems which forced him to retire from competition in September of 1997. He retired seven weeks after he was named to the first US Team which will compete at the 1998 World Boomerang Championship in the St. Louis area.

Gel Boomerangs makes many of the competition-grade sticks players have relied on for more than a decade. Gel's Phenolic Sunshine, Rad German, Bellen Wind Dancer and Carlota Doublers are among the favorites of competitors. Gel Boomerangs have won 9 national awards from the USBA for design and technology and have been used by seven people to set 11 world records.

The company will be missed from the standpoint of the general promotion of boomerangs. Gel Boomerangs markets boomerangs in many retail outlets in the San Francisco Bay area and across the

(continued on page 21)

(continued from page 11)

too - you have to grind it down to the actual line you made for a pattern. I can't tell you how much you want a rotary hard rubber drum sander for this; I use one 3" long by 3" diameter, that has interchangeable sanding cylinders available for it. I use an 80 grit for almost everything; it is aggressive, without being obnoxiously grabby. Make certain your boomerang is held at 90 degrees to the drum, and holding the blank with both hands at comfortable positions (not near the sanding drum), start grinding. After you put on eye protection, ear protection, and start the dust collector, that is. Grind right down to the line. Important tip - this one isn't even an advanced tip, it is something to strive for, right from the beginning. You really do NOT want to do one small area, go right to the line, move an inch down, do it again, etc. This will make a very lumpy boomerang; trust me. Keep it moving up and down, so that you are doing a 4 to 6 inch area all at one time. It all gets down close, then, on one easy final swoop, all four to six inches gets its final edge applied. If you remember one thing from this discourse, this would be the one to cling to. You will be amazed at the difference doing this makes in your boomerangs, and if you are not doing this now, start. At the tips, this will not be easy; it may not even be possible at the inner area of the elbow. Do what you can here, with this tool. The areas you cannot reach can be reached with a Dremel rotary tool, a Foredom cable tool, or an industrial die grinder. If worst comes to worst, and you have none of these, a rounded file will work. You want an aggressive cutting tool, so ask for a bastard cut file. I didn't make this name up, that is its name. There are other cuts available; ask at your local hardware store what they recommend. A rasp may induce tearout, so be careful with them. I should note that plywood works very well, in these procedures; plastic tends to melt into a mushroom-like ball, and phenol just plain smells pretty bad. Do not touch those mushroom-balls of plastic when just ground; they are hot, and will burn you. Scrape them off with a shop knife of some sort kept near the grinder.

The next step is probably the easiest one here; determine which side should be uppermost. This will then determine which side will have the airfoils applied to them. In plywood, if your shape is shaped such that the left side looks exactly like the right side, in reverse (a "mirror image"), you can now orient either the side you drew the original pattern on, or use the opposite side. Check the natural bend in the wood; in most two-bladers, you want a

slight bend upwards at the tips, if the flat side is laying on a horizontal surface. Put the blank down on a table, hold the elbow down, and tap the tips of the boomerang, one at a time, with the other hand, like a telegraph key. If it clicks on both arms at the tips, in one position, the side that is up should be the upper surface which will get the airfoils applied. If neither side clicks, turn it upside-down, and if it still doesn't click, it is flat, which may be good or may need tuning (that will be addressed later). I mark the top surface with a small "T" in pencil, when I am making several at a time, so that I know which side to grind, when it is time to do so. If you put it close enough to the edge, the "T" is ground off, in the rounding off process, so you don't even have to sand it off later.

The next step is to apply the airfoils. I also use the 3" x 3" grinder for this operation. I look at the uppermost surface of the boomerang, and visualize which wing will rotate which direction, in the finished boom. In the wall hanging position, a right-handed boomerang will want the leading edge (rounded edge) to be on the right of both wings, and the trailing edge (beveled edge) will be on the left of each wing. A left-handed boomerang will be reversed from this. For the first time you make a boomerang, mark the areas you want rounded, before you do it, or you might screw up. Ask any boom maker who has made over 50 booms; if you ever applied an incorrect edge to a boomerang, will you please raise your right hand? If your right hand is now not up, and you made over 50 boomerangs, you are most likely lying. I even keep my plywood failure of this sort (by the way, the only one I ever screwed up this way) directly in front of my grinder, on the wall, as a reminder.

Remember, that if you magnify a rounded over edge, it is actually a series of flat planes, connected edge to edge. In other words, if you had a tool, like a plane, that only cut off flat planes of wood, and you had to round over a large board, you could approximate a roundover by tilting the plane 10 degrees over, taking a pass at that angle, tilting to 20 degrees, take a pass, tilt to 30 degrees, etc. That is what we are going to do here; take several passes on the leading edge areas to create this rounded profile. Leave the bottom 30-40% of the airfoil untouched, and you are going to round off about 1/4" to 3/8" of material on the top ply. I think I make 3 or 4 passes, each time rotating the blank, getting closer to the position I was in making the edge (in the step where we ground the edge down to the final line). I can do the

entire leading edge in about 5 to 7 seconds on a plywood boomerang with straight wings, and rarely more than 20 seconds on a curved or bent wing.

When you get to the end of the lead arm, you reach the end of the wing. Now you have a decision to make. Wing tips are important to the flight, actually very important. Long distance models require a fairly square profile (barely rounded off); MTAs and certain F/C models require beveled edges, not unlike a trailing edge, and intermediate length models have intermediate airfoils, somewhere between a full bevel, but more than a rounding off. Make your choice, and do it.

The bevel is pretty easy, for the trailing edge, but beginners should note that the tendency is to take off too much. Leave at least 30%, and I prefer to leave 40%, of the trailing edge thickness untouched. DO NOT TOUCH THE LOWER 1/3 OF THE THICKNESS OF THE WING EDGE WITH YOUR BEVEL. Taking it lower does not increase lift; it merely weakens the boomerang too much there. If you want more lift, make the angle of the bevel such that more of the top surface is removed (a shallower angle off of the horizontal plane that is the top surface of the boomerang). In a typical boomerang, you want 1/2" or more off of the top surface; rarely do you want to go more than 3/4". This should be a flat plane; holding the boom at an appropriate angle, keep taking passes as you get more and more off, until you are at the level you need.

The other areas of concern are the external elbow, and the internal elbow. Everything near the elbow is typically a rounded edge (leading edge), although in rare circumstances, builders attempt to make a miniature "third wing" out of this external elbow area, and put a small trailing edge on the trailing edge of this area. Both the external and internal areas should be rounded, exactly like you did for the other leading edge areas. The internal elbow will most likely be attacked with the same tool you used there before - the Dremel, the Foredom, etc.

The next step is to sand any areas you ground previously with either the 3" x 3" drum, or Dremel or Foredom or rasp, etc. This sanding is best done with a palm sander (the orbital sander, discussed earlier) on plywood models, and on some plastics it works, too. If you move it too quickly, you will leave "figure-8" swirls on the plywood. I suggest a grit of either 100 or 120; this will be a good enough finish for plywood. You can really manipulate this sander around, and use the edge or corner of the

(continued on page 24)

Letters

(continued from page 2)

by the wind, then you can use the same argument for MTAs. Only the MTAs don't need as much wind to blow them downfield.

The question is really whether MTA is a good event, due to the fact that catching a nice thermal is a matter of luck. To give everybody a shot at good conditions, you get five throws, in rotation with the rest of the field. Hopefully you get some lift on one of your throws. But even if there is a thermal out there, you still need the skills to get a good throw. A crappy throw in the biggest thermal is still 25 seconds. A good throw in dead air can be 35 seconds. So, certainly, getting a thermal is lucky, but you need that perfect throw to get 40 seconds or more.

There have been many tournaments where people run up to catch a thermal they see someone else riding, and get excited and chunk the throw for a goose egg. But I've also had days where there were big scores out there, but every time I threw, the throw was perfect, but the boom dropped like a rock and I got lousy times. So, luck is still involved to some degree. So...

Here's my suggestion to the rules committee that is working on the rules for the 1999 season: Let MTA scores reflect some sort of consistency. For example, an average of your top three throws. That way, if someone does get that lucky ride for 50 seconds, but hasn't got any other times, their score would be 16 seconds. Meanwhile, the guy who hasn't caught a thermal, but has five times around 25 - 30 seconds, would have a score around 27 seconds. Or maybe an average of your top two scores. This system would reward throwers consistency and skills, while still rewarding that great flight someone gets every now and then.

'Chicago' Bob Leifeld
Waterloo, Illinois



Lag B'Omer

(continued from page 18)

were excellent throwers.

We were treated well, ate well, sold some booms and only had gas expenses to worry about. We have even received some e-mail from several people who attended thanking us for being there. We have probably gained some customers too. We have considered several changes for future demos.

At one of the locations we were asked if we

could provide unpainted boomerangs for the kids to decorate. We could easily do this with the Trovicel tribladers and use felt tip markers. Another consideration would be to make some 12 inch basswood cross-sticks and leave them unpainted. These would probably be good for even the youngest of throwers. We have also stocked up on TriFlys at reasonable prices and will use them too. Anyone who needs a quantity of these can contact us and we will try to work out a deal. We are definitely ready for Lag b'Omer '98 but may have to buy some rain ponchos first!

In 1998, Lag B'Omer will fall on May 14 which is a Thursday. Although this may be inconvenient for many of us who have 9-5, Monday to Friday jobs, it is well worth the effort.

Until May 14th... Shalom!



CLARIFICATION

The president's desk column in the last issue (MHR #70, Fall 1997) was actually a post to the RangList e-mail community addressing specific concerns of many RangList subscribers. The column was not approved by the president for publication in Issue 70 of MHR.

The president was preparing such a column but did not meet the deadline. The RangList e-mail was run instead without the permission of the president. As MHR's editor-in-chief, I take full responsibility for this. It was an error in editorial judgement by me. I apologize to the president for publishing her letter for a different purpose than it was originally intended without her permission.

The president realizes that there are more timely and important issues to the membership than competition reform and US team selection. The topics which the president really wanted to address to the membership will be addressed in a future issue of MHR.

Tony Brazelton
Editor in Chief
Many Happy Returns

Gel

(continued from page 19)

country. The company's mail-order business is one of the largest in the boomerang industry and its website is regarded by many to be the best in information, organization, and layout.

Girvin has been suffering from multiple disk damage for several years which has impeded his boomerang career on and off for several years (see story in MHR #70, Fall 1997).



CORRECTION

There was an error in the ratings (MHR #70, Fall 1997) which affected the Accuracy event and the Season Overall Ratings. Jason Smucker should have had 7 Overall placing points in Accuracy event, moving him up 10 places to 34th in the Season Overall Rankings. Players ranked 34th to 42nd will now themselves one place lower in the Season Overall Ratings. Those ranked 14th through 20th in the Accuracy event will find themselves one place lower. No other ratings were affected. We apologize for any inconvenience.

Keith Mullinar's phone number was incorrectly printed in the Fall issue. His correct phone number is (860) 986-6396.



For the very best quality Finnish Birch Plywood with a 5% USBA discount: mention this ad

Anderson Int'l Trading
1171 N Tustin Ave.
Anaheim, CA 92807
(800)-454-6270
(714)-676-8183



THE BOOMERANG MAN

"Giving fast, personal service since 1975"

RICH HARRISON'S ANNUAL CATALOG

1998 CATALOG FREE!!!

1806 North 3rd St., RM - Monroe, LA 71201; (318) 325-8157
fax: 318-329-1095, Internet: bmanrich@iAmerica.net

THE USBA STORE

www.staff.uiuc.edu/~brazelto/USBAstore.html

PO BOX 182 DELAWARE, OHIO 43015

How to Order

Place orders by sending check or money order to the address above. Prices include shipping to US and Canada.

Overseas Clients

Add US\$2.00 for surface and US\$4.00 for airmail. Pamphlets and back issue newsletters are US\$1.00 extra for surface and US\$2.00 extra for airmail.

All proceeds from the USBA store go into the general USBA treasury. Your purchases subsidize the US Team, *Many Happy Returns*, and insurance premiums for the USBA among other expenses.

Questions?

Phone or fax
(614) 363-4414
 or e-mail
boomerang@midohio.net

CLOTHING

- ◆ 1996 US Open T-shirts \$16.00 (L, XL)
- ◆ USBA Eagle T-shirts \$12.00 members, \$15.00 nonmembers (L, XL, XXL)

LITERATURE

- ◆ 1996 USBA Competition Rulebook \$2.50
- ◆ *Boomerang*, a book by Ben Ruhe \$6.00
- ◆ "The Boomerang" an early pamphlet by Ruhe and Hawes \$4.00
- ◆ "Low Reynold's number airfoils" scientific paper \$2.50
- ◆ Individual back issue of MHR (inquire for availability) \$2.50
- ◆ Get one set of ALL available MHR back issues for only \$25.00!

Gift Certificates Available in Any Denomination!

USBA Member Boomsmiths and Retailers

www.staff.uiuc.edu/~brazelto/memvend.html

Aboriginal Steve's Boomerangs

Active Vermont

Air Traffic Kites and Games

Boomerangs by Ted Bailey

The Boomerang Man

Broadbent Boomerangs

BVD Rangs

Channel Craft, Inc.

Circle Stix

Cleveland Boomerang School

Colorado Boomerangs

John Cryderman

Fly Boy Boomerangs

Gel Boomerangs

Gemz

Greyford Co. Boomerangs

Kalmanson Boomerangs

Leading Edge Boomerangs

Left Turn Boomerangs

Fred Malmberg

Master Designs Boomerangs

Outback Boomerangs

Rangwrights

Rangsmith

Roundtrip Boomerangs

Ruhf Boomerangs

Dan Russell

San Francisco Boomerang School

Stix by Steve

Stone Mountain Boomerangs

Turning Point Boomerangs

Steve Conaway 121 Oakdale Ln., Fillmore, CA 93015

John Flynn PO Box 4425 White River Jct., VT 05001

M. Hedberg & L. Sandifer Mall of America Minneapolis, MN

PO Box 6076 Ann Arbor, MI 48106

Rich Harrison 1806 N. 3rd St. Monroe, LA 71201

Gary Broadbent 3204 38th St. NW Canton, OH 44718

David Hendricks 1086 Gordon St. Allentown, PA 18103

D.J. Helfer PO Box 101 North Charleroi, PA

Stuart Jones 195 E. 5th St. #605 St. Paul, MN 55101

Dave Boehm PO Box 17385 Euclid, OH 44117

407 W. Tomichi Ave. Gunnison, CO 81230

John Cryderman 136 Thames St. Chatham, ON N7L 2Y8 Canada

Kelly Leggett 7180 Lakemond Ct. Villa Rica, GA 30180

Michael Girvin 2124 Kittredge St. #61 Berkeley, CA 94704

Tony Gembeck PO Box 5241 Portland, OR 97208

Thomas Risher Box 4734 Whittier, CA 90607

Neil Kalmanson 766 Old Nunez Rd. Swainsboro, GA 30401

Chet Snouffer PO BOX 664 Delaware, OH 43015

Norm Kern 1640 Haynes Birmingham, MI 48009

1545 E. Market St. York, PA 17403

Kendall L. Davis 932 21st Street Rock Island, IL 61201

Doug DuFresne PO Box 25577 Portland, OR 97225

John Derden 451 Colegrove Dr. Swainsboro, GA 30401

T.W. Smith PO Box 11332 Eugene, OR 97440

G. Snouffer & R. Tilford 340 troy Rd Delaware, OH 43015

Peter Ruhf 6550 Meeting House Rd. New Hope, PA 18938

Box 84895 San Diego, CA 92138

Bill Tumath 127 Knollview Way San Francisco, CA 94131

Steve Collins 4820 Hillcrest Okemos, MI 48864

Dan Jones 222 N. Main St. Statesboro, GA 30458

Eric Darnell Star Route South Strafford, VT 05070

(805) 524-2913

(802) 296-7244

(612) 858-9599

(734) 971-2970

(318) 325-8157

(330) 492-RANG

(610) 434-7305

(412) 489-4900

(612) 228-1393

(216) 442-6024

(800) 35RANGS

(519) 354-3984

(888) 213-0084

(510) 658-2469

(503) 230-8955

(912) 237-7831

(740) 363-8332

(248) 645-9308

(717) 848-4601

(309) 793-9885

(912) 237-7831

(503) 465-9461

(740) 363-4414

(215) 863-3479

(619) 296-4243

(415) 550-6746

(517) 349-5234

(912) 489-3640

(802) 765-4336

14 models for comp and fun boomerangs and outdoor gear
 retailers of Colorado, Flight Stix, Gel, Outback, more comp B's, newsletter, mini B's, books
 retailer of many models, credit cards accepted
 comp booms, demos, lesson plans & supplies
 variety of models
 fax (412) 489-0773 recreational woodcraft
 demos, workshops, info phone or fax
 variety of booms, workshops
 recreational booms, comp booms
 hardwood strip laminates, buyer boomerangs
 full spectrum of comp and sport B's, T-shirts, more variety of wood B's and comp clothing
 manufacturer and distributor, buyer, retailer
 Kalmanson reversible art boomerangs
 comp and beginner B's, FC, doublers, more
 8 models from beginner to comp
 rare hardwoods, lap joints
 15 models to choose from + special orders
 beginner to comp B's, fast catch, strip laminates
 birch ply, lap joints, poly & PVC B's, beginner to comp
 full spectrum incl. dist., indoor, backyd, comp B's
 whls/retail, indoor, bkyd, beginner to comp, T-shirts
 comp & beginner booms, specialize in lefties
 wood booms, cyalume stix, call 4-8pm
 Herb Smith dealer
 beginner to comp, FC, TC, AR, art booms
 birch ply, natural elbows
 fax same number, Tri-Flies

Attention manufacturers and retailers: Any USBA member who manufactures or distributes boomerangs or related products or services may be listed free of charge as a service to our members. Send description to: Boomsmith Listings c/o USBA 2405 Lawndale Drive Champaign, IL 61821 or fax to (217) 244-8371 attn: Tony Brazelton.

Calendar of Events

www.staff.uiuc.edu/~brazelto/calendar.html

USBA Sanctioned Tournaments

Date	Event	Contact
August 30	Emmaus Night & Day Tournaments - Emmaus, Pennsylvania	Barnaby Ruhe (610) 967-3683
September 6	4th Annual Illinois Classic - Champaign, Illinois	Tony Brazelton (217) 352-6184
Sept. 12-13	2nd Annual Kitty Hawk Kites Invitational - Nags Head, NC	Kitty Hawk Kites (800) 334-4777

To petition the USBA to sanction a tournament or other event, contact Chet Snouffer.

Chet Snouffer
51 Troy Road
Delaware, OH 43015
e-mail: 103327.3123@compuserve.com

Other US Events

Date	Event	Contact
May 16	Toss Across America	Betsylew Miale-Gix (206) 485-1672
July 26-Aug. 2	World Cup Championship - Edwardsville, Illinois	Tom Fitzgerald (314) 839-1604

Regional Clubs and Contacts by State

www.staff.uiuc.edu/~brazelto/clubs.html

AZ	Phoenix	Desert Southwest Boom Chuckers and UFO spotters	Mark Weary & Don Monroe	4026 East Cholla Canyon Dr. Phoenix, AZ 85044	(602) 759-3973
CA	San Diego		John Weigel	1323 La Mesa Ave. San Diego CA 91977	(619) 462-4379
	SF Bay Area	Bay Area Boomerang Club	Michael Girvin	2124 Kittredge St. #61 Berkeley CA 94704	(510) 658-2469
	Santa Barbara		Erik Fields	1501 Clifton St. Santa Barbara CA 93103	(805) 564-4840
	Santa Cruz		Brad Westervelt	Voicemail 800-286-6310, box 748	(408) 338-0818
	Southern	Southern California Boomerang Alliance	Steve Conaway	121 Oakdale Lane Fillmore, CA 93015	(805) 524-2913
	Southern		Paul W.K. Rothemund	533 South Hudson Apt. #1 Pasadena CA 91101	(626) 584-1807
CO	Aurora		Richard Pollock-Nelson	2530 S Ouray Way Aurora, CO 80013-1576	(303) 368-5933
CT	Madison	The Wandering Nutmeg Boomerang Society	Paul D. Sprague	782 Boston Post Rd. Madison CT 06443	(203) 245-8211
	Shelton	Team Gel East	John "Moleman" Anthony	21 Huntington Ave. Shelton CT 06484	(203) 924-6735
FL	Merritt Island	Flite Stix Boom Slingers	Rich Surace	855 E Crisafulli Rd. Merritt Island FL	(407) 452-3963
	Orlando		Carl Morris	2602 Breezewind Dr. Orlando, FL 32839	(407) 859-1319
GA	Atlanta	Atlanta Boomerang Society	Frank Golder	#2 Capitol Square rm 370 Atlanta, GA 30334	
	Swainsboro	South Georgia Boomerang Club	John Darden	131 College Cir. Swainsboro, GA 30401	(912) 237-7831
IL	Champaign	Illini Boomerang Club	Tony Brazelton	2405 Lawndale Dr. Champaign IL 61821	(217) 352-6184
	Waterloo		"Chicago" Bob Leifeld	P.O. Box 242 Waterloo, IL 62298	(618) 939-9023
MD	Rockville		Jim Nieberding	Rockville, MD 20853	(301) 933-1073
MI	Ann Arbor		Ted Bailey	PO Box 6076 Ann Arbor, MI	(734) 971-2970
	Birmingham		Norm Kern	1640 Haynes Birmingham, MI 48009	(248) 645-9308
	Lansing	Mid Michigan Boomsling Club	Steve Collins	4820 Hillcrest Okemos, MI 48864	(517) 349-5234
MN	Mnpls/St Paul	Boomerang Organization Of Minnesota (BOOM)	Stuart Jones	195 E. 5th St. Apt. 605 St Paul, MN 55101	(612) 228-1393
MO	St. Louis	St. Louis Boomerang Club	Tom Fitzgerald	1159 Holly River Dr. Florissant, MO 63031	(314) 839-1684
NM	Albuquerque	Sandia Boomerang Club	Steve Sanders	10408 Woodland, NE Albuquerque, NM 87111	(505) 294-8842
OH	Ashland		Dwight Souder	453 Parkwood Dr. Ashland, OH 44805-4135	(419) 281-4565
	Canton	Gary Broadbent's Boom Shop	Gary Broadbent	3204 38th St. NW Canton, OH 44718	(330) 492-RANG
	Columbus	There And Back Again Boomerang Club	Bob Lackey	31 E Dodridge Columbus, OH 43202	(614) 263-6840
	Delaware	Free Throwers Boomerang Association	Chet Snouffer	PO Box 664 Delaware, OH 43015	(740) 363-8332
	Delaware	U.S. Head to Head Boomerang Tournament Organization	Gregg Snouffer	340 Troy Rd. Delaware OH 43015	(740) 363-4414
	Euclid	Cleveland Boomerang School	Dave Boehm	PO Box 17385 Euclid, OH 44117	(216) 289-6324
OK	Oklahoma City		Joel Bussey	1516 Southern Heights Ave. Norman, OK 73072	(405) 447-2117
	Bartlesville		Steven Graham	924 Yale Drive Bartlesville, OK 74006	(918) 333-0730
OR	Portland		Tim Schallberger	4740 SW Hamilton St. Portland, OR 97221	(503) 241-9618
PA	610 area code		Dave Hendricks	1086 E Gordon Street Allentown, PA 18103-2208	(610) 434-7305
TN	Knoxville	Boomerang Club at the University of Tennessee (BCUT)	David Martin	2912 McNutt Avenue Maryville, TN 37804-2537	(423) 687-3179
TX	Houston	Boomerang Association of Texas	Greg Corum	3233 Magnum Rd. Apt 184 Houston TX 77092	(713) 681-0837
UT	Sandy	Wasatch Boomerang Club	Jim Miller	2095 E. 10095 South Sandy, UT 84092	(801) 942-6943

(continued from page 20)

sander to get into almost any internal elbow area possible. Again, if you don't have such a sander, hand sanding is possible; I would start

machine is the equivalent of almost a 600 grit hand sanding.

Now, we're almost done. All that remains is perhaps a final sanding, with 150 to 200 grit

of boomerangs, or want to venture into rare wood boom building. There, it is a necessity. Finishes will be covered later, but the boom should be test flown now. If the flight is im-

Advanced TIP

People have asked me often how to make the boomerangs as smooth as I do. The thing I see they often do not do is part of this step, which I call "justifying the edge". I borrowed this term (okay, I stole it) from guys who do scraping on fine furniture. They go through a multi-step process in preparing the scraper for use (a scraper acts like sandpaper, but it also "burnishes" the wood, which imparts a kind of sheen not possible with most sanding). One of their steps involves a similar act of edge hardening by drawing a file, at 90 degrees to the edge, across the scraper. I hand sand, at 90 degrees to the edge, along the edge, until the edge is flat both by visual and tactile examination. I hold the boom so that the elbow is in front of my left eye, maybe 2 inches away, and the tip of the involved wing is maybe a foot in front of my right eye (kind of like "sighting" down the boom edge, like it is a rifle, with my left eye, and the "rifle" is aimed a little to the right), then close my left eye and open the right. You can immediately

see any irregularities in the edge of the wing. When you have done this to all four wing edges, use your thumb and forefinger as guides, run them simultaneously down one wing, the whole length, and then down the other. What you are looking for is not a perfectly flat edge, the whole length; boom building would be pretty boring, then. What you want is what I humbly have coined as "smoothly continuous". If there is a swelling out as a planned flare-out at the wing tip, make it join smoothly with the rest of the wing. Does any of this make a difference in flight? Probably not, or little if at all. Does it make for a nice boomerang to view, and to hold? Absolutely. In fact, I consider this "smoothly continuous" concept to be the second of the important factors in boom building (along with the concept of "keep the edge moving", while sanding; in fact, if viewed carefully, there is definite overlap in these concepts, and I hope the reader can see that).

at 100, go to 120, and then 150 to get a similar finish. Note - because the sander vibrates, it is effectively sanding at a level much higher than the grit that is on it. In the random orbital sanders, for example, a 220 grit finish done by this

sandpaper, on the large flat areas. This can be done by hand, or by orbital or random orbital sanders. Perhaps the ideal tool for this is the random orbital sander, but I don't recommend it unless you really get into making lots

proper, tuning is best done now, before paints or sealers are applied. Tuning will also be covered as a later discussion.



In the next issue of

Many Happy Returns

SPRING
1998

- 70% of Everything You Need to Know: Part II
- Tips for Booming in Wind
- 1998 World Championship Preview
- Much, much more!

Submit your materials **now** for inclusion in the Spring issue of MHR. See inside back cover for details.

WANTED:

a home for

www.usba.org

The USBA recently acquired the domain name *usba.org*. Unfortunately, we do not have a server to house this new domain. The simplified domain will help the world find boomerangs a little easier than with the current URL, www.staff.uiuc.edu/~brazelto/USBAinfo.html.

If you have a computer capable of acting as a server for the USBA website and would like to help the USBA achieve a prominent web presence, please contact Tony Brazelton at brazelto@uiuc.edu.



the United States Boomerang Association

GENERAL INFORMATION

The USBA is a non-profit organization whose goal is to promote the art, craft, sport and poetry of boomerangs through events, competitions, and information distributed through the quarterly newsletter, *Many Happy Returns*.

USBA BOARD OF DIRECTORS

President

Betsylew Miale-Gix (452) 485-1672

Vice President

Chet Snouffer (740) 363-8332

Treasurer

Gregg Snouffer (740) 363-4414

Secretary

Tony Brazelton (217) 352-6184

Directors

Eric Darnell (602) 759-3973
Mike Dickson (330) 499-9848
Larry Ruhf (413) 323-4340
Keith Mullinar (860) 986-6396
John Flynn (802) 296-7244

GENERAL CONTACT INFO

Address

USBA
PO Box 182
Delaware, OH 43015

Website

www.staff.uiuc.edu/~brazelto/USBAinfo.html

MEMBERSHIP INFORMATION

USBA membership entitles you to four issues of the quarterly newsletter *Many Happy Returns*, reduced entry fees for USBA-sanctioned tournaments, discounts on plywood from Anderson Int'l., discounts on books, and early notice of special offers.

Non-USBA members may receive one free trial issue by submitting the form on the left or by visiting the website.

Check your newsletter address label for issue of expiration. Membership status inquiries should be addressed to the Treasurer.

MHR ADVERTISING RATES

Full page	\$100
Two columns	\$75
Half page	\$60
One column	\$50
Per column inch	\$5

10% discount for four consecutive issues. All advertisements must be pre-paid in USD by check or MO to **USBA**. The editor reserves the right to refuse any advertisement or cancel a contract without notice. The deadlines for all advertisements are published inside the back cover of every issue.

MEMBERSHIP FORM

USBA members: Copy this page and carry extra copies in your boombag. Your membership is extended one issue if a new member lists you as a sponsor below.

Name _____

Address _____

City _____ State _____ Postal Code _____ Country _____

Sponsor's name _____

Check one

- New member (check or MO enclosed)
- Renewal (check or MO enclosed)
- Trial issue (no payment required)

Dues

North America

Annual \$15
Lifetime \$225

Outside North America

Annual \$20
Lifetime \$350

Make checks payable to **USBA**

Send this completed form along with payment to:

USBA MEMBERSHIP
PO Box 182
Delaware, OH 43015

Tips for Submitting Articles to MHR

Each issue of *Many Happy Returns* has a subset of themes which are relevant to the time of year that the issue is published. Persons contributing to MHR may wish to keep these themes in mind when deciding on the appropriate issue to which to submit one's writing. Please also keep in mind that contributions need not be limited to these themes. Details for submitting text and graphics can be found inside the front cover.

WINTER Deadline

January 1

Themes

- Making boomerangs
- Calendar

SPRING Deadline

April 1

Themes

- Making boomerangs
- Comp preparation
- Calendar

SUMMER Deadline

July 1

Themes

- Comp technology
- Event summaries
- Calendar

FALL Deadline

November 1

Themes

- Event summaries
- Calendar



**United States Boomerang Association
PO Box 182
Delaware, OH 43015
USA**

**BULK RATE
U.S. POSTAGE PAID
PERMIT NO. 453
CHAMPAIGN, IL**

*If the number above your name is
or less, it's time to renew!*

72

