

Many Happy Returns

Issue No. 78

An International Publication of the United States Boomerang Association

Spring 2000

German Young Guns Win World Cup 2000 Manuel Schütz is New World Champion



Issue #78

MANY HAPPY RETURNS



MHR - New Editor

by Ted Bailey

Greetings. This issue of MHR brings with it additional changes in an organization that relies heavily upon it's membership for volunteer services. At this time, I would like to introduce myself as the new editor of MHR, taking over from Tony Brazelton who remains as the hard working volunteer USBA web master.

My first experience with a boomerang was at age 9 (1959). My first boomerang was an early plastic Wham-O which I lost when it crashed through the window of a neighbor's house about a week after my mother gave it to me. I didn't touch another one until 1974 when I was an Engineering student at C. S. U. Sacramento. I became passionately involved with making and throwing booms at that time. In 1975, I became one of the Boomerang Man's first customers and Rich became the first person that I corresponded with regularly about boomerangs. The first person that I met whom I did not teach to throw was Rusty Harding. I discovered that he lived in Vero Beach, Florida, only 30 miles from where I was living in 1979.

The first competition that I attended was the 1982 Free Thrower's tournament where I took a first place in Fast Catch using a RH plastic Wham-O and throwing with my left hand. From that point on I became heavily involved in the development of high tech competition boomerangs, beginning with the production of high performance miniature booms and quickly moving to MTA, Fast Catch and other designs. I won a few tournaments in the 1980s and even if I did not win, I usually placed fairly high in individual events. In 1986, I

was the first person to successfully do solo Super Catch. I retired from competition in 1989 but I occasionally compete for fun in tournaments organized by fun loving guys like Michael Girvin and Norm Kern.

My involvement with the USBA began in the early 1980s. I joined when the USBA newsletter was called "Return Mail" and John Mauro was the editor. I have served as President, Secretary, and board member.

I was the dominant force in eliminating the absurd international rule for defining a legal boomerang as having only two blades. I wrote the legal definition of a boomerang that is used throughout the world today, modified only slightly by fellow Engineer Dennis Maxwell who lobbied hard for the new rule in a very stubborn Australia.

I have been heavily involved with the production of MHR, including 2 previous terms as editor in the late 1980s and early 1990s, this period separated by two years when I produced an independent newsletter called "Boomerang Journal". For the past 5 years, I have edited and produced another boomerang publication titled "Boomerang News". I decided to stop production of that newsletter and return to MHR when the editor position became vacant. I have agreed to edit MHR for at least the next 8 issues.

In some ways, this issue is a return to the past. I have resurrected my 1994 MHR newsletter template and art. I also plan to bring back the Bits & Pieces column that I used to cement together all the small pieces of news that pass my way between issues. I do plan to add new features to MHR as well, including coverage of boomerangs on the ever changing World Wide Web.

I do want to hear from members who have comments or material to add. My contact information is listed on page 19.

What's In This Issue!

Page	Contents
2	New USBA Editor: The USBA has a new editor. Ted Bailey has returned for 2 more years.
3	President's Column: Chet Snouffer details changes in the new USBA organization.
3	Boomerang News: Boomerang News is still alive and well. Andy Cross continues this popular newsletter from his home in Canada.
4	Bits & Pieces: Lots of tid bits about boomerang events, products and happenings from all around the world.
9	Split & Bore Wood Didjeridu: How to make a didjeridu from a hardwood board.
10	The 2000 World Cup: Stuart Jones provides in depth coverage of the big event of the year.
16	Prehistoric European Boomerangs: Shamans made and used horse headed throw sticks in Scandinavia thousands of years ago.
17	Electronic Boomerangs: How to construct an electronic circuit for a dynamic night boomerang with flashing lights.
18	World Boomerang Assoc. Chet Snouffer issues the minutes from the WBA meeting that was held at the 2000 World Cup
18	USBA Calendar of Events: Find out when and where boomerang events will occur around the USA.

President's Column

A New Era!

Welcome to a new era, US boomerang enthusiasts! And I do mean a new era!

A new board of directors has been seated and is busy cranking out services and products to make the USBA a viable, responsive organization. Here are just some of the changes and highlights you should look for right away!

1. The newsletter! Our "new" editor Ted Bailey is back producing MHR for the next 2 years. If you know Ted from his fabulous "Boomerang News" you know this means timely, informative newsletters cranked out every quarter, like clock work!

2. The merchandise and the USBA Store! Pat Steigman is working on an entirely new line of USBA merchandise and an overhauled, revitalized USBA Store. Patches, stickers, cool stuff!!

3. The grass roots movement! Betsy Miale-Gix and Eric Darnell are coordinating the annual Toss Across America on May 20 as well as smaller, regionally held Tosses throughout the year. Great opportunities to get together without the need for a tournament!!

4. The Art of Boomerang! Fred Malmberg is rewriting the rules for the Design Competitions and clearing up the whole area of art and design. We want to acknowledge and award the creators of stunning, intriguing, technologi-

cally mind-boggling, artistic boomerangs from wood, plastic, natural elbows, you name it! Look for greater emphasis on this aspect of boomeranging starting right now!

5. Publicity/Media coordinator! Fred is going to start the ball rolling with a centralized media/marketing plan to raise awareness of boomerangs using the web, media, and more!

6. The web page! USBA.org is being overhauled, revamped, re-born! Tony Brazelton has shed some of the awesome workload he did for USBA before and is focusing on the web page alone! Look now if you haven't lately and see what's up!

7. Your involvement! What are you up to? Are you a webmaster? Get ahold of Tony and offer to help. When you're not chucking boomerangs, are you secretly the head of an ad agency? Get ahold of Fred! We know you aerodynamic engineers are lurking all over out there...you sure keep the rang-list humming with physics of flight chatter! Expend some of that pent-up knowledge on an article for the newsletter so credit or blame can go where it should!! As new president, I want to utilize the experts in the field on every endeavor we take on...and that means you! Email me at: USBA-pr@usba.org and let me hear your feedback, ideas, and services you have to render!

Full circle flights,

Chet Snouffer

What Ever Happened to "Boomerang News" ?

Many "Boomerang News" subscribers who were owed extra issues are now new subscribers to "Many Happy Returns" (or you have had your USBA membership extended). Look for your membership expiration number on this issue to see if your USBA membership was extended.

Many of the readers are unaware that Boomerang News is still going strong. It has been resurrected by Andy Cross from Calgary, Canada. The costs for 8 issues of Boomerang News is \$15 Canadian (\$10 US) for both the USA and Canada and \$30 Canadian (\$20 US) for overseas. If you have any boomerang related information or upcoming events, please forward the information to Andy to include in upcoming issues of Boomerang News. You can contact Andy by email at: across@teluplanet.net or call him at (403) 293-7307 or write to:

Andy Cross
50 Falshire Terrace NE
Calgary, Alberta T3J 3B3
Canada

For those of you who are looking for back issues (#1 -> #60), please contact Pat Steigman who has reprinted back issues in 5 sets of 12 issues/set. Each set of 12 issues costs only \$16, and this includes postage to the USA. If you live elsewhere, please ask Pat for a quotation. You can email Pat Steigman at: psteigman@tyler.net or call 903-581-5556 or write to:

Pat Steigman
716 Wellington St.
Tyler, TX 75703-4665

The text from back issues of BN can be sampled at RP-N's web page: <http://members.aol.com/pollocknel/index.htm>

Introduction to Bits & Pieces

For the past 15 years, this editor has always summarized the letters, emails, phone calls and tid bits of information received from the readers in a column called "Bit's & Pieces". This was the format of "Boomerang News" for which I was the editor before returning to MHR. As editor of MHR, I will continue the "Bits & Pieces" column with news segregated by country so that the reader can quickly go to the region of the world that interests you most.

The "Bits & Pieces" column will contain information about tournaments, world records, new products and clubs and just about anything that is of broad interest to the membership. The best way to submit information for this column is to send the editor an email message or, if photos or drawings are part of your story then send them in a letter. My contact information can be found on the bottom left of page 19. "Bits & Pieces" is your column, so please send information that you think would be of interest to MHR readers on a regular basis. The more you send, the better the column will be.

Bits & Pieces

errata: In MHR #77, we forgot to credit Ross Snyder for the photos of the 1999 USBA Nationals. Sorry Ross, great Pics!



One of the best ways for the USBA to communicate with the membership is by email. Billy Brazelton has initiated a really great USBA emailing news update service. This news update is intended to inform USBA mem-

bers of all boomerang-related events in a more timely and efficient manner than is possible with MHR. It will be sent at least once a month, plus special announcements that are too important to wait. Possible news items may include but are not limited to:

USBA board activities, competition announcements and results, and general discussion about running the USBA. If you have an email address, please send it to Billy as soon as possible so he can add you to the USBA emailing list at: braz0026@tc.umn.edu

Ted Bailey will email a summary of MHR to current USBA members only who have provided their email address to the editor at: tbailey@ic.net

The Boomerang Organization Of the Greater Evergreen Region (near Seattle) is hosting the Twin Peaks Tournament on June 24th and 25th. They plan to have LOTS of fantastic trophies - last year there was a pile of real boomerangs made by Southbay Johnny, Will Herlan, TW Smith and others. Enough so everyone got one boomerang each day, and a couple of extras on the last day. Koa, lap joints, underhanded, aussie round, collectable painted booms, etc. The contests are beyond the usual fare. First, Long Distance with US Record Holder Dan Neelands as the home field champ. Next, Gel team events with the likes of Steve Kavanaugh going for another 138 points in Haccuracy in a single throw. After feasting on too much fresh seafood on Saturday night, you'll struggle onto the field Sunday morning and face the USBA individual competition. See the calendar on page 18 for contact information.

Dean Kelley will host the 13th Annual Western Oregon Boomerang Roundup in Salem, Oregon on July 9, 2000. The tournament will be held at the McKay High School soccer fields. All USBA events will be contested.

This year the event will be held in conjunction with Salem's SportsFest weekend. This is a weekend in which many different sporting events will be held so expect a good spectator turnout. Please see the calendar on page 18 for contact information.

The Burlington Boomerang Competition will be held on July 29, 2000. Call 802-859-3430 or email: fatelvis@together.net or visit the following web page: <http://homepages.together.net/~fatelvis/comp.html>

Will and Betsylew Miale-Gix are organizing a Toss Across America event at a Regional Boy Scout Jamboree with 4,000-5,000 scouts plus leaders. The TAA will be on a military base that is open to the public that weekend. More about this in the next issue.

Natalia Martinez markets a large variety of sterling silver and 14K gold jewelry (charms, necklaces, pins, key chains, money clips, etc.) with a boomerang theme. Natalia sent the editor a very large catalog to review. There were dozens of spectacular boomerang jewelry items for sale that would be of interest to many of the readers. Prices are very good too. Anyone interested in finding out more about boomerang jewelry can e-mail Natalia at: nataliamtz@home.com or call: (619) 216-3516 or write:

Natalia Martinez
1075 Torrey Pines Road
Chula Vista, CA 91915

The Boomerang Man has a really nice supply of Leanne Loveland's Wycheproof decorated Coachwood Boomerangs. All three models (19 inch traditional, regular hook and contest hook) are top rated products and priced to sell at \$21 ea. or set of 3 for \$60. For more information, contact Rich Harrison by email at: boomerangman@centurytel.net or you can write to:

**Boomerang Man
1806 No. 3rd St.
Monroe, LA 71201-4222**

Pat Steigman is quite a craftsman. He has made several strip laminated copies of Manuel Schütz's famous long distance Voyager hook. Pat is keeping one of them. The second one was sent to Manuel Schütz. The third one was auctioned off for \$110 in the Spring 2000 auction and the last one is going to the next person who breaks the 200 metre barrier in an official competition. This beautiful S/L hook if framed for display, but you can throw it too. What a wonderful incentive for throwers to get out and make/throw booms for one of our most exciting events. You can email Pat at: psteigman@tyler.net or call 903-581-5556 or write to:

**Pat Steigman
716 Wellington St.
Tyler, TX 75703-4665**

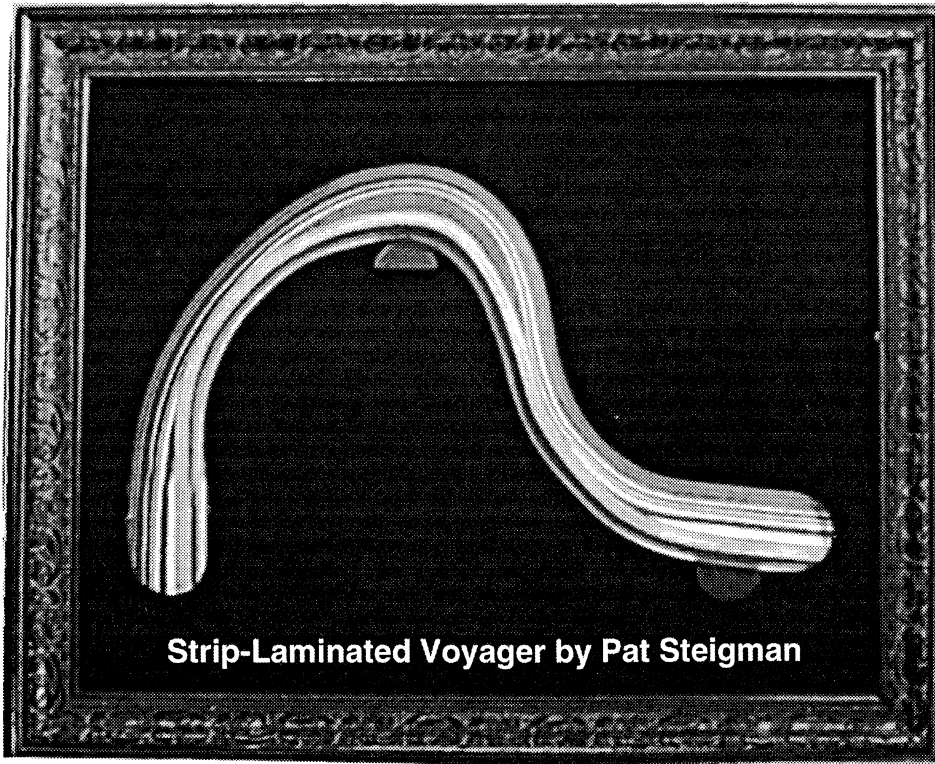

Strip-Laminated Voyager by Pat Steigman

Prentiss Faw has an unusual problem. He has a warehouse full of wonderful high quality cross sticks made in the 1950s. Prentiss has had many customers over the years. One was a traveling salesman who would step outside of the motels he stayed and fly and sell them. He sold literally hundreds, and gave the profits to his church. He retired, but Prentiss still ships him a carton every now and then. Prentiss also sells to a boy in Ardmore Oklahoma who lived on the road to Lake Murrey. He would fly them in a vacant lot and sell them to passersby. These boomerangs are a great item for youth groups such as Boy Scouts or Girl Scouts, either to raise money or use as a project. Prentiss is willing to sell them at an attractive price to MHR readers. Each box contains 24 cross sticks which includes a rod to insert through a hole in the center to aid in catching. The cross sticks really work well. They are unpainted. If you have a retail business, you can also add them to your stock. A box of 24 costs

only \$54. You need to contact Prentiss for shipping charges. You can contact Prentiss by email at: pmfaw@net66.com or by writing to:

**Prentiss M. Faw
802 Harrison
Charleston, IL 61920**

Creative Synergy is an Advertising Specialty and Promotional Products business based in the USA. They are looking to purchase quality boomerangs in lots of 100 or more. Boomerang manufacturers can make contact by calling 805-526-1962, emailing Glen at Createsyn@aol.com or by writing to:

**Glen D'Souza
Creative Synergy
1977 Suntree Lane, Ste #B
Simi Valley, CA 93063**

John Bordelon found an article by the Associated Press in the 13 February issue of the Marietta (Georgia) Daily Journal titled "A Driving Obsession". The story features Steve Cook and mentioned Jason and Laura Smucker as well.

John Derden was browsing through a back issue (February 1995) of Southern Living magazine and found an article on page 65 about a home owned by Travis and Odette Strahan. The article did not mention boomerangs, but John's eagle eye noticed a nice looking boomerang hanging on a cabinet knob with a shape and art similar to a Janetski Skippy. The house is in Early Branch, South Carolina. I am sure Gary Broadbent will be paying them a cordial visit on his next trip through the area.

National Geographic World is doing a special issue on Australia for their August 2000 issue. This issue will include an article about Cassidy Uluru, a tribal elder who makes boomerangs near Ayres

Rock. Mr. Uluru was selected to light the torch for the 2000 Olympic Games.

AUSTRALIA

Russell Hansen has initiated a new boomerang eGroup, "aus-booms", for discussion of Boomeranging in Australia. It has a mailing list, an event calendar, chat room, talk, file vault, database & link list. Everyone is welcome to join and discuss anything, but the primary focus will be on happenings within or connected to Australia and the BAA. To post a message to the list, email to aus-booms@eGroups.com. To join for free, go to www.egroups.com and look for aus-booms.

BELGIUM

Pierre Cattelain mentioned that the famous traveling boomerang exhibit from the South Australian Museum was displayed at the Musée du Malgré-Tout in Treignes from 30 January through 30 April. This exhibition included over 250 original boomerangs, dating from the XIXth and XXth centuries, displayed by region of origin on large panels. The exhibit has previously been shown in San Francisco, London, Imola, Utrecht, Helsinki and Osaka.

The catalogue of the exhibition was written by Philip Jones, Senior Curator at the South Australian Museum in Adelaide. The catalogue is in French, 48 pages, 154 illustrations and is available by mail for 400 BEF (65,-FRF / 9,92B), including postage. Payment on the Giro account 000-1464466-57 of the CEDARC/Musée du Malgré-Tout with the indication "Catalogue Boomerang". You can get more information by writing to the CEDARC/Musée du Malgré-Tout, 28 rue de la Gare, B-5670 Treignes, Belgium or visiting the web page: <http://users.skynet.be/cedarc/>

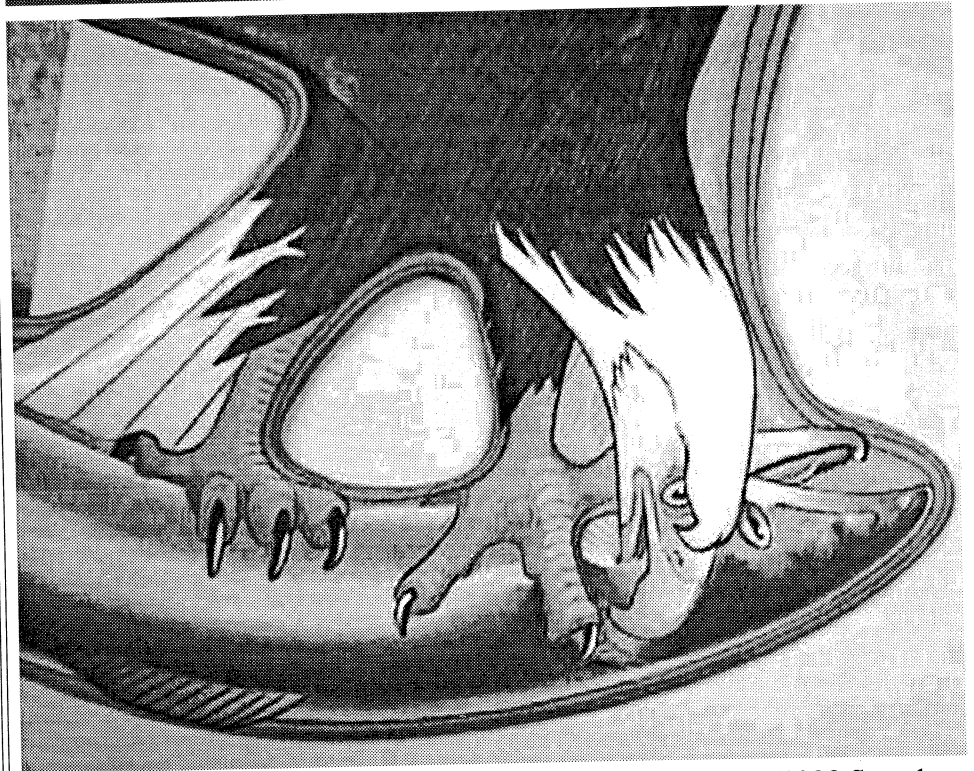
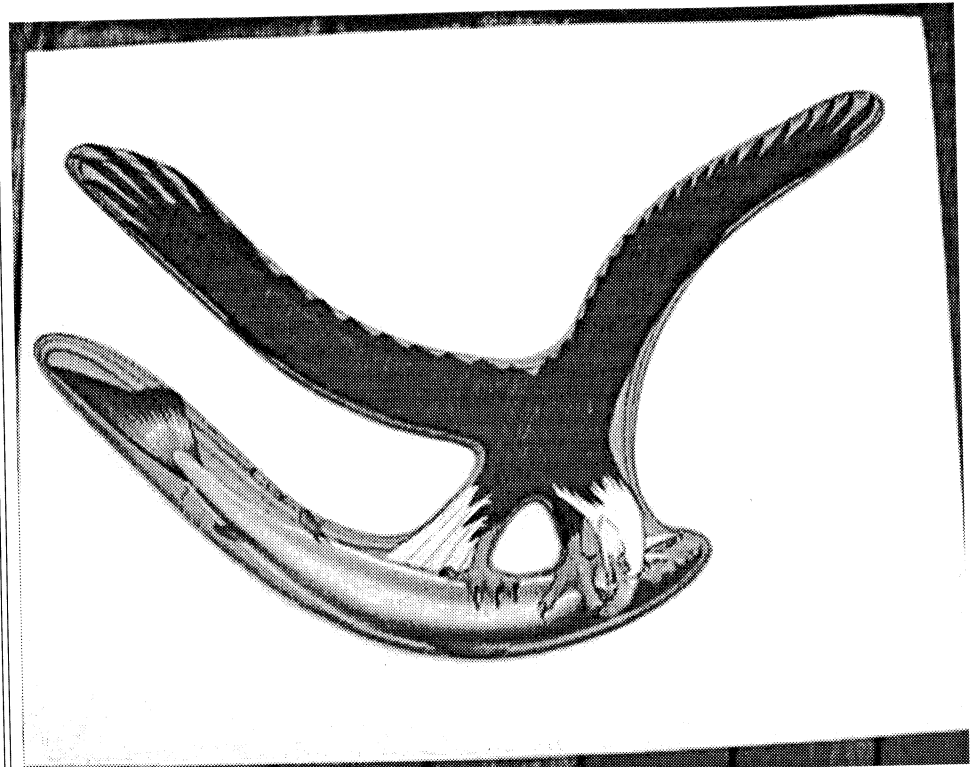

Will Herlan bought a boomerang from Martin Wikström (1998 Scandinavian team called the Salmon-Eagle. Martin said it flies like an eagle, and you grab it out of the air like you grab a salmon from a stream. It was a beautiful boomerang and had a good flight pattern for such a lumberyard. Will sent it to his brother-in-law, Dennis Dentel of Grosse Pointe Woods, MI who has a degree in Medical Arts Illustration. Dennis did an incredible Eagle/Salmon painting on this boom as shown below. Will would like to re-establish contact with Martin but has been unable to locate him. If you can help, please email Martin's contact info to Will at: blugar@gte.net

ENGLAND

The Financial Times of London published an article titled "Many Happy Returns For 'Rang Maker: Minding Your Own Business: Andrew Eames meets a German specialist in boomerang production on 25 January 1997. Do any of the readers have a copy of the article or know who the boomerang maker was? If so, please share this with the readers.

Chris Leadbeater of FHM magazine, (For Him Magazine) wrote a short piece on boomerangs as part of a series on rising sports. Did any of the British readers get a copy of this publication?

CANADA

Sensodyne Toothpaste purchased a large selection of Aboriginal and strip laminated boomerangs in January for a commercial involving the flight of a boomerang. The boomerang was supposed to be throw in an indoors studio (no wind) and have a range of 40 feet with a constant 6 feet altitude, wings parallel to the floor. The boomerang "crashes" against a big tooth. Have any of the readers seen this commercial?

FRANCE

Jacques Thomas is circumnavigating the Southern hemisphere in a sailing vessel to do honour to the French navigators La Perouse, D'Entrecasteaux and Nicolas Baudin who made the same trip in 1801. Jacques was able to throw and catch boomerangs at the Southern ends of three continents: Cape Horn, Cape of Good Hope and Cape Leeuwin. Jacques even made it to a tournament in Australia on 31 March where he presented awards for the "nearest the pin" event.

On 23/24 September 2000, there will be an international indoor boomerang tournament to celebrate the 20th Birthday of Laval boomerang club. Laval is between Le Mans and Rennes in the

west of France, 1h30 from Paris by train. Everyone is welcome to come and share in the celebration. For more information, email Luc at lcormier@club-internet.fr or write to:

Luc CORMIER
12 rue des Acacias
53260 ENTRAMMES
FRANCE

Thierry Brunner landed a job last year with an Anglo Australian coal mining company located on the equator in Borneo. The mine is a big open cut (15 million tons / year). He is the only Frenchie at the mine and he has been very welcomed both by the Australian expat community (35 families) and the 2600 Indonesian employees. Thierry is a general manager in charge of Human Resources, Community and Government Relations issues.

Amongst all the Aussies, Thierry is the only boomerang thrower/maker. The mine has a cricket field on the top of a hill, and during the week ends, Thierry gives boomerang lessons to the cricket players after the cricket game. If you want to find out more about boomeranging in Borneo, contact Thierry Brunner email: thierry.brunner@kpc.co.id

ISRAEL

Congratulations go to David Ben-Hador who has received U.S. Design Patent (# D0422321) for a Flattened Boomerang on 4 April 2000 (see drawing, above right). The design incorporates a hinged flap for adjusting the tune.

SLOVENIA

Zoran Jarnovic was featured in February on Slovenian National TV in a prime time Sport Quiz. First there was a boomerang com-

petition between three Olympic candidates to decide who gets to compete for Slovenia in Australia this year. They used Backyarders and did the filming inside of a gymnasium. The presentation lasted 11 minutes and was well received by the television audience.

It is time to start making your booms for the U.S. Open Design Contest. Boomerangs can be entered into a technology or artistic divisions. Other booms will be separated into one of four categories: natural elbow, strip-laminate, lapjoint, or sheet construction (made from a sheet of material, plywood, phenolics, plastics, etc.). If a boom has multiple parts of each, the maker shall chose which

category in which to enter it. From each of these four

groups, there will be two division winners chosen: an "aesthetics" winner and a "construction" winner.

WWW

Tony Brazelton has just launched a completely revamped USBA web site. The new site has much better navigation,

a redesigned format, and is generally more user-friendly. Check it out right now at www.usba.org. The goal is to make the website both a good introduction to boomerangs for prospective members and a useful reservoir of information for current members. Tony can't achieve this goal on his own, though. We need volunteers to work with Tony to make the USBA web site the ultimate source of boomerang information. Specifically, we need people who are willing to maintain specific

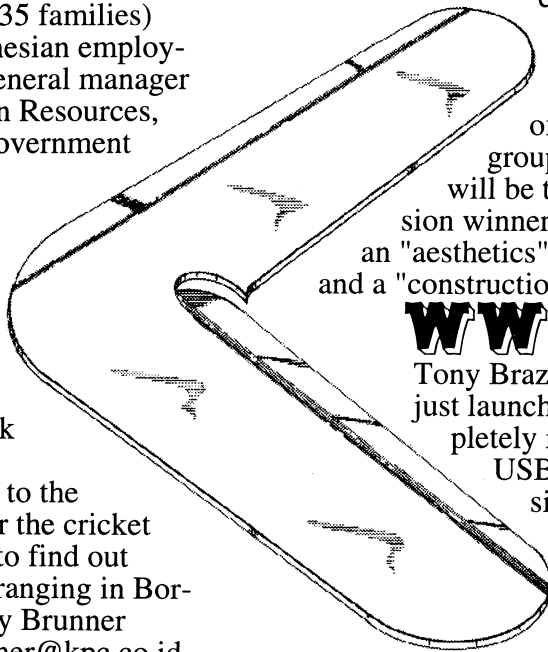

parts of the site (such as scores and rankings) or contribute articles and information on specific topics (such as history, science, and craftsmanship). If this sport is going to grow like we want it to, the USBA web site has to be top-notch. If you are interested in helping out in any way, contact Tony at brazelami@yahoo.com.

Check out the throwing field for the 2000 USBA Nationals at: <http://www.outasites.net/canton.htm>

The USBA has new bumper stickers for sale at \$1 each + postage. You can see what they look like at: <http://www.cox-internet.com/psteigman/bumper1.jpg> Please email Pat Steigman at psteigman@tyler.net if you are interested in purchasing one or more. Also, 3 1/2" round red USBA logo stickers are available for 50 cents each. You can order these with your bumper sticker.

Will and Betsylew Miale-Gix have a new email address: betwil@wa.freei.net

The Boomerang Association of Australia has initiated a forum for Australian boomerang throwers with internet access. This is a nice way of getting communication going within the BAA. You don't have to be a member of the BAA. You can sign up at the following URL: <http://www.users.bigpond.com/redgum1/egroupsubscribe.htm> or send a blank e-mail message to: aus-booms-subscribe@eGroups.com One of the highlights so far is an exclusive report by Russell Hansen about the recent Long Distance tournament in Brisbane.

There is a new boomerang organization called the Central Ohio Boomerang Renaissance Team. For more information, you can visit their web pages at: <http://www.geocities.com/pipeline/jump/8639/home.html> and at http://www.geocities.com/cobra_oh_2000

La Pérouse Boomerang Club de France has a new web page at: <http://perso.club-internet.fr/mmonnot>

Steve Sanders of the Sandia Boomerang Club is putting together a more or less comprehensive story on the history of the boomerang on his web page. He would love to have any historical photo images, showing people, events, etc. from the early days of development (Smithsonian, early tournaments, Aussie/USA Challenge, World Cups, Al Gerhards, Bunny Read, Janetzki's, Herb Smith, etc.) to post on his page and share with the world. If you can help, please email Steve Sanders at: ccc27@pop.nmia.com

Jeff & Karen Lammers have a great web site called Flying Toys that has a large selection of flying toys including boomerangs. Check out their other flying toys, especially the paper airplane products: <http://www.flyingtoys.com/>

Josh Garvin and Niell DuVal have posted a web page for their J&N Boomerang Products. They have put a real great web page together with boomerang history, instructions and of course their catalog products. Please visit: <http://jnboomerangs.com/>

The Boomerang Resort is located in Branson, Missouri: <http://www.boomerangresort.com/>

New Scientist has posted a web page with an explanation as to why a boomerang returns: <http://www.newscientist.com/lastword/answers/lwa519gadgets.html>

Steve Conaway received a glorious moment of fame when Staronline published an article about his boomerang experiences: <http://www.staronline.com/lifestyle/277205.shtml>

Peter Kovari of Hungary has changed his web page address to: <http://www.extra.hu/kovarip/boomerang/boom.html>

Steven Graham has a new boomerang web page at: <http://home.bartnet.net/~grang/grang/>
Matthew Longthorpe and Paul

Worcester of Eyewood Designs specialize in the design and construction of boomerangs and are one of the UK's leading boomerang specialists. You can find their website at <http://www.eyewooddesigns.f9.co.uk>

Hide and Mike Kobayashi of Japan have a new e-mail address: hide@rangsjapan.co.jp and web site: <http://www.rangsjapan.co.jp>

Geoff Hatcher has launched a new web site with hand carved, hand painted, Finnish Birch plywood booms at: <http://www.hatcherboomerangs.com/>

Mutsumi Tamada has posted a new boomerang page in Japanese at the following URL: <http://www.geocities.co.jp/Athlete-Athene/8537/>

Flyables is a simple AOL web page from San Diego with links to several pictures of different boomerang designs: <http://members.aol.com/flyables/>

About.com has an informant page about boomerangs at: <http://inventors.about.com/education/inventors/library/inventors/blboomerang.htm?rnk=r&terms=bboomerang>

That large beaded foam four bladed boomerang called the Zoomerang is back. You can find it for sale on Yahoo at: <http://search.shopping.yahoo.com/search?P=all&p=boomerangs&hc=0&hs=327&b=61>

An Aussie named Hugh Hunt has written a British web page titled "Unspinning the Boomerang" with a real neat scientific explanation for why a boomerang returns: <http://pass.maths.org/issue7/features/boomerangs/>

The artifacts depicted on the following web page were sold as replicas of Neolithic German throwsticks by the Detroit Museum of Art as they thinned out their storage rooms. Gerhard Bertling tracked the origin down as WW II vintage manufactured replicas of German neolithic stone axes: <http://www.flight-toys.com/boomerang/germans.htm>

Spring 2000 Boomerang Auction

Many of the readers are aware of the bi-annual auction of competition and collectable boomerangs that the editor runs in the Spring and Fall. In the Spring 2000 Auction, approximately a third of the boomerangs were donated to benefit the family of Jim Mayfield. Jim died last Fall as a result of injuries sustained in a motorcycle accident. The proceeds from the donated boomerangs raised a total of \$3000 for the Mayfield family. Not all of the boomerangs were donations. Among the offerings was a Janetzki boomerang, a couple of Herb Smiths, the last 9 Jonas Romblad MTAs and a few other juicy collectables. The top prices paid in the auction include the following:

Bid	Manufacturer	Item
\$500	Janetzki, L & A.	Pintubi
\$285	Romblad, Jonas	Jonas MTA
\$285	Romblad, Jonas	Jonas MTA
\$285	Romblad, Jonas	Jonas MTA
\$285	Romblad, Jonas	Jonas MTA
\$250	Romblad, Jonas	Jonas MTA
\$249	Romblad, Jonas	Jonas MTA
\$226	Romblad, Jonas	Jonas MTA
\$208	Romblad, Jonas	Jonas MTA
\$201	Romblad, Jonas	Jonas MTA
\$155	Schütz, Manuel	Quirl X-treme
\$151	Smith, Herb	Tigarang
\$150	Craig, Alan Scott	Kangaroo Motif
\$146	Flynn, John	NE Hook
\$137	Smith, Herb	Mogul
\$120	Malmberg, Fred	Lap Joint
\$110	Steigman, Pat	S/L Distance Hook
\$109	Cardiff, Pat	Sea Turtle
\$103	McMahon, John	Traditional
\$93	Timbery, Joe	Natural Elbow
\$90	Aborigine	Throwstick
\$80	Colorado Booms	Performance Group
\$75	Colorado Booms	Special JM Boom
\$70	Cardiff, Pat	Leopard Frog
\$70	Cardiff, Pat	Chinese Dragon
\$69	Smith, Herb	Original Essay
\$66	Cuartas, Oscar	Tucan 39
\$63	Cardiff, Pat	Jim Mayfield
\$61	Conaway, Steve	Un-Delicate Arch
\$60	Darnell, Eric	Box of triFlies
\$60	Foresi, Bob	Yanaki Natural

The next auction will take place in the Fall of 2000. Anyone who wishes to submit one or more items should contact Ted Bailey before 15 June to reserve space. You should call (734)-971-2970 or email: tbailey@ic.net at your earliest convenience.

Split and Bore Wood Didjeridu

by Jesse Gay

Introduction:

My father, his friend, and I just finished constructing a really nice didj out of a 4x4 of knotless douglas fir. I've never heard of anyone using the method we used, so I thought I'd share it with the MHR readers.

Materials and Tools Needed:

1. A 4x4 of the length you wish your didj to be, I used 6 feet.
2. A table saw.
3. Another long straight piece of wood.
4. Waterproof wood glue.
5. A lot of wood clamps.
6. An electric hand planer
7. Leather strips.

Construction Procedure:

We began by slicing the wood in half lengthwise on the table saw.

Notice that this is different than just buying two 2x4s, since it insures that you will get two absolutely flush edges. Then comes the new step. We clamped the long piece of straight wood onto the table saw, on the left side of the blade, at approximately 10 degrees to the left of center, using totally in line with the blade as 0 degrees. We then ran each half of the 4x4 through this jig several times, using several different blade heights in order to approximate a taper on the inside. We had the final blade height @ 3/4" @ the mouth piece end(keep in mind that since you are working with halves, the blade height will = half of the final diameter, so in this case I have a 1 1/2" diameter mouthpiece (wax excluded), and 1 1/2" at the other end. By running the wood through at an angle, you effectively use the blade as a router bit, which rips a semi-

circular canal through the wood. This is not quite how table saw blades were meant to be used, and as such this method created a lot of heat and potential for kickback, so it is important to take the blade height up in several steps. For example, we started off at 3/8" and used three 1/8" increases until arriving at the desired 3/4" semicircle.

Then we cut off the corners of our two halves, so as to make planing the outside into an approximate truncated cone that much easier. After the inside had the correct shape, the two pieces were glued together and clamped tightly.

You can save yourself trouble at this point by wiping off excess glue while it is still wet.

When the glue was dry, we used the hand planer to shape the outside. After that, we used a small router bit to round the inside of the mouthpiece end. If a router is not accessible, a rasp would work too, it would just be a bit of a hassle. I wrapped each end with leather strips in order to prevent splitting. Hose clamps work well too, but they do not look as nice. Finally, the instrument was finished on the inside and out with mineral oil, and a beeswax mouthpiece was added.

The didj sounds great and I highly recommend this method to anyone looking to have a nice wood didj that is more affordable than one from Australia, while sounding much better than one made of bamboo or ABS plastic. Possible areas for experimentation include: deliberately roughing out, or smoothing out the inside, using different woods, or carving and/or burning designs on the outside.

Happy playing,
Jesse Gay ph: (503) 230-0711
email: jgay@reed.edu

The 2000 World Cup

story by *STU-ee Jones*
photos by *Br. Brian Thomas*

After 16 hours in a plane from the U.S., it sure was great to see Günter Möller of Germany and some fellow boomerangers waiting inside for me at the terminal in Melbourne. Outside in the warm Aussie air was the BOOMERANG BUS, driven by Bruce Carter, Victorian Boom Champ, waiting to pick up any and everyone who arrived at the airport. A big hurry and thanks to Bruce for picking up, what seemed to be 50% of the competitors from all over the world, at one point, 28 people staying over for at least one night. His wife Kay and sons Craig and Trent were great Aussie friends who did everything to make their boom friends an Aussie experience to remember.

The big warmup to the WC on 1-30-00 was the 2000 Seamist, Victorian Boomerang Championships, about 100k from Melbourne. Upon arriving with a caravan of vehicles, KANGAROOS had to be removed from the boom



Trent Carter Shows Bruce How to Launch a MTA



Stuart Jones Getting Ready to Throw at Victorian Seamist Comp

site. Gary Broadbent came up to me and said "A bite from one will make you bleed for a month" in an Aussie accent. Gary was kidding but the roos were great, along with the Kookaburras, "laughing in an old gum tree". With 33 competitors from several countries (including 5 women) in windy conditions, the top throwers were: 1st Gary Broadbent, 2nd Gregg Snouffer and 3rd Stephane Marquerite. Hats off to Bruce Carter again for a fun/finely organized tourney.

With approx. 120 boomerangers from 10 countries converging on LaTrobe University for dorm living and boomeranging on 2-5-00, the excitement was really starting to peak. Each country had their own little area in the dorms, with sayings in every language, on most doors. By sheer coincidence, two of the throwers on one of the two Aussie teams had shoulder injuries, and they asked me to fill in. Of course I didn't refuse!!!! STU-ee was on an Aussie team, a dream come true!!! and happy too!!!

Sun. 6 Feb.--- Official opening in the morning with Aborigine Murrundindi tossing out the ceremonial boomerang and other Aborigines demonstrating Woomera spear throwing followed by Br.

Brian Thomas throwing the original King Billy Hook, loaned to him by Mr. Sinclair, the godfather of boomerang tournaments in Australia. The Aussies name a corresponding Australian animal for every team name, 15 team animal names. In alphabetical order they are: Australia Fever 1 (Emus); Fever 2 (Wombats); Canada Snow Birds (Cockatoos); France Pirate 1 (Kookaburras); France 2 (Dingoes); Germany Knochen (Koalas); No Mercy (Kangaroos); Young Guns (Penguins); International Womens (Possums); Japan Pokemon (Wallabies); Samurai (Galahs); Swiss Skandal (Platypus); U.S.A. Boom Bros. (Red backs); Turtle Tribe (Goannas); Wild Cards (TassieDevels); Old Crocs (Just Old) (the 16th team).

Comp for the day is Australian Round, Super Catch, Endurance,



The Original King Billy Hook!

Trick Catch/Doubling, Team Relay. Hot conditions with some wind were on the field for the day, like 7 inches from the mid-day sun, so to speak. The Young Guns came on like THE force they are and took the day with 73 points, narrowing out the Turtle Tribe who had 62, followed by Knochen 60 and Pirate 1 with 56.5.

Mon. 7 Feb. - Comp for the day is Endurance, Aussie Round, Super Catch, Accuracy, MTA, Team Relay. Still HOT and getting Windier. Some teams were really coming on strong, trying to catch the YGs, like the Turtle Tribes 68.5 that out did the Guns 66, on this day, but France fades back with a 35, as Knochen has 56.5, and the Samurais on everyones heels with 55. Then it was back to the dining hall for food, planning and rest.

Tues. 8 Feb. - Comp for the last team day is Super Catch, Endurance, MTA, Aussie Round, Trick Catch/Doubling, Team Relay. HOT again (40 on the Celsius, or 100+Fahrenheit) and the wind is up. The YGs now have a comfortable lead, holding the other teams back. Only the Wild Cards are catching up. But this is the last team day and catching the

Young Guns is impossible. The U.S. teams came over to win but no luck. For the 3rd consecutive World Cup, the German Young Guns are still the Number 1 Boomerang Team in the world. Behind them are, 2. Turtle Tribe, 3. Wild Cards, 4. Knochen, 5. Samurai, 6. Pirate, 7. Swiss, 8. Fever 1, 9. Boom Bros., 10. No Mercy, 11. Fever 2, 12. Pokemon, 13. France 2, 14. Snowbirds, 15. International Womens Team, 16. Old Cross (always last). The awards banquet was really a blast. From the food to trophies, everyone was smiling, yawning and having FUN.

Wed. 9 Feb. - Comp for the day is the World Indoor Championship and Long Distance. The indoor comp was in the gym on campus and the LD was at another field BIG enough to handle 200 meter rangs or maybe farther. Bruce Carter organized the indoor comp. with Fast Catch and Trick Catch, using all air dancers furnished by Eric, and a list of catches that only the most agile could hope to catch. Like Mark Weary or Adam Ruhf or Nobu even Craig and Trent Carter, did have a chance in a field of about 20. It came down to Mark and Adam in



Janetzki Boomerangs Were Everywhere to be Seen

trick catch with Mark just narrowing out Adam for the top spot. One minute Fast Catch/ Endurance was taken by Gary Broadbent with 13 and Frederic Declercq, with 11, who was just walking by to actually go swimming, when the pull of fellow rangers in that gym was just too much to resist.

On the Long Distance field it was HOT...but the winds were favorable. David Schummy set up this event with a field of, well,,,,,, the best in the world, himself, Manuel Schütz, Gary Broadbent, Roger Perry, Will Herlan and even Harald Toft from Denmark. Finally I made it to the site and had to talk my way into the lineup, but had to do my field duties first. So upon sitting down with my umbrella, too close to the center and had a wild return flight from someone, that was it for SITTING and HEADS UP STU-ee, Roger said. As we were out there at about 130m, we could hardly see the max. dis. point of the flight. Both Roger and myself were kinda spooked.



BAA Legends: Dennis Maxwell, Br. Brian Thomas, Bob Burwell, Morris Maxwell

We stayed and saw Manuel throw and return a 199m flight which won the event and was the longest flight I've ever seen personally. David Schummy came in 2nd & Gary Broadbent came in third.

Thurs. 10 Feb. - World Individual Championships; Comp for the day is Aussie Round, Trick/Catch, Doubling and Endurance. The forecast calls for HOT, like 40 C (110 F) and 40+MPH gusts. Still morning and good winds for Australian Round. Mike Gabriel (US) with 79 and Sascha Winkler (Ger) with 83, were no match for Adam Ruhf of the US with a 89 to show his inherited skill at boomeranging to take top place. Trick Catch was just that....without Doubling. By this time WIND was becoming a factor, and two rangs were just TWOOOO much, so tricky catching it was. 98 World Individual champ Fridolin Frost took the honors here with 162, followed by Harold Steck (Ger) and Manuel Schütz.(Swiss). By the time lunch was over, the winds were ridiculous, kinda like HURRICANE FORCE !!! Endurance starts and we suddenly realized 1 catch in 1 min. was not good. I painfully watched Axel Heckner, one of the best in Germany, catch about 5 in

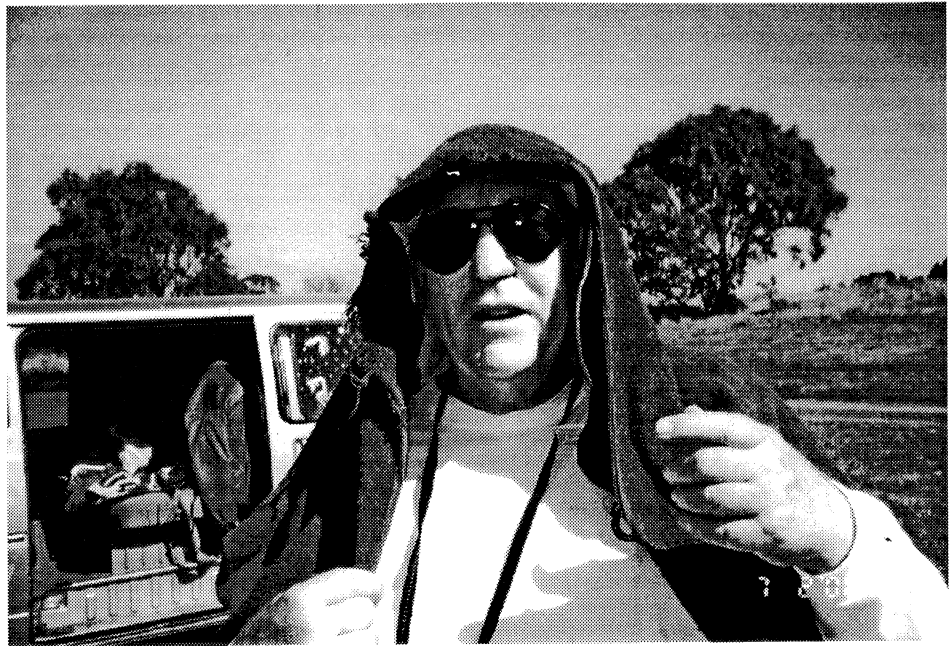

Brother Brian Thomas Protects Himself From the Brutal Sun

5 min. OUCH ! On another field, rangs were being BLOWN AWAY into a nearby lake with giant waterfowl. Only Mike Gabriel was able to catch 12 after the first round, way,, way low for world competition. The tournament was halted until a decision could be made. This took about 20 min. and the wind was still increasing !!!!!
 >> WIND DECISION 2000 <<
 After voting on field and taking

sides, Rob Croll announces that the comp was cancelled until a check of wind at 4:00 would be made to continue. Mother Nature had her own plans and the wind never stopped. Everyone dispersed to different places anyway. Back to the dorms for food and R&R.

Fri. 11 Feb. - The comp for the day is finishing Endurance from the day before, Fast Catch, Accuracy and MTA. Wide weather change from yesterday. It's misty, rainy, but the winds are down!! Now at about 40 degrees cooler at least with wetness we could deal with it. Scores were finally up in endurance and 64 from Adam and 61 from Manuel set the stage so no one could catch them. Fast Catch and Accuracy only added to their behalf. MTA was won by Harold Steck with 40.07, with ME right behind with less than 1 sec. difference (39.13), Togai Yasuhiro(39.02) but John Gorski's flight went flying away with Rob Croll in pursuit "on a bike". Rob was able to follow it and return it to John.

Manuel Schütz (Switzerland) is the new Individual Boomerang World Cup Champion. His throwing and sportsmanlike qualities



Adam Carroll Watches Manuel Schütz and Tibor Horvath Prepare to Throw

got him to the TOP. Not far behind him were: 2. Adam Ruhf (US); 3. Harald Steck (Ger); 4. Mike Gabriel (US); 5. Casey Larrance (US); 6. Fridolin Frost (Ger); 7. Oli Thienhaus (Ger); 8. Steve Kavanaugh (US); 9. Nobu (Japan); 10. Thomas Szartowicz (Ger)

Sat. 12 Feb. - The day begins with everyone rested and ready to board 2 huge buses for a tour of the HEALESVILLE SANCTUARY. The bus I was on had about 48 people aboard with Gregg Snouffer on a mic. along with Wayne the Aussie driver. Between Wayne's commentation and Gregg's comments, we were really having fun just on the ride there, about 100K away. There were beautiful vineyards and rolling hills all the way to Healesville. Upon our arrival, we went straight to the Birds of Prey area, except via the KOALAS, on the way

there. We were only 4 ft. away from these little Australian icons, as they ate eucalyptus leaves. We were then given a show of really cool birds. A Kite(like a hawk), Owl and a beautiful Wedge Tailed Eagle, were the stars of the show, flying only inches from our heads. Then everyone went off in different directions to explore the animals of Australia. From Alligators to Tasmanian Devils to the Duck Billed Platypus, it was Nature's best from DOWN UNDER. Next at the sanctuary was, YarraYarra Aboriginal Dancer" Murrundindi ". Inside we heard the sounds of Didgeridoo, and were given a history lesson on the brotherhood of the Aboriginal culture. At one point Murrundindi had all the team captains on stage for a try at aboriginal dancing, WOW was this a sight ! Also he presented Gary Broadbent Jr. with a sportsmanship necklace he

made and FEATHERS OF HOPE for Gary's younger brother and sister. Outside we had a throw in a tight area, but Murrundindi and the others that threw, gave everyone there a great show. As this show ended, I had to push away some large Emus, just to escape a quick downpour, on the way back to the buses. We leave for a tour of a RAIN FOREST. Murrundindi is our guide here, where TIME and NATURE combine into a story of Aboriginal history and the food they would eat. On a wooden walkway we would stop and listen to him explain why HUGE gum tree's were down from a century ago's logging, and what the aborigines of Australia should do now, to preserve their history. Then its back to the buses and back to LaTrobe U., just in time for a great barbecue. Later that evening was the individual awards. Where Manuel put all

photo by Betsylew Miale-Gix



Torsten, Aaron, Garrit, Steve K, Harald, Gregg, Günter, Betsylew, Oli, Chet, Frido and Adam

those trophies to go home with, I'd like to know!

Sun. 13 Feb. - The last day of this boomerang bash is FUN/GEL day. Stevie organized the day with inside funfly GLORP, then outside with Juggling, Whoa Nellie(Aussie Round & Trick Catching) and GLORP. Starting before breakfast, funfly GLORP with 20 throwers/catchers. From the beginning Stevie DOMINATED !! With a list that had Br. Brian, Mark W., Adam R., Manuel and even Chantal and Doug DuFresne, it came down to Mark & Stevie. Well....Stevie won and then proceeded to lead us to the boom site for some real Glorping. Outside in breezy conditions, Stevie still dominated Juggling with 15 to win this, by staying UP wind while everyone else had to run back back,back. Next it was ' WHOA NELLIE '. All I know about this event is when I saw Morris Maxwell and Br. Brian rolling on the turf in laughter, the CAM had to come out. Filming these guys and the others was enough to make me forfeit the rest myself, but taping was worth it. Believe it or not while WN was almost over, Leonie Metzakis, a circle judge, and myself helped a BLIND women (Merrisa) throw and attempt to catch an air dancer equipped with cellophane attached for sound. Zippy helped too, with the sound of his voice, If only she could have seen him. She kinda 'HEARD' the boom back, you know? Jokes aside this was AWESOME !! Time for GLORP. This was a favorite of mine, even though I glorped out early, the best were left. By halfway thru this, the beer, mostly (Victorian Bitter) was flowing, Gregg was on the mic again and the field of throwers was narrowed down to Mark W. and Casey L. When Mark was the last dominator he used my folding chair as a throwing and catching device. He caught his under the leg but few

others did. Still it looked like Casey won, as some fun shoving and more VB was being opened, even Oli came up to make a few comments, in German, to the camcorder. Then it was back to the dorms for dinner and later the campus pub for farewells, fun awards ,VB, song and dance, completing an INCREDIBLE BOOMERANG EXPERIENCE.

Last , the people who made this happen, deserve a big congratulations. From David Shummy and his computer, operated by Angie Perry & Paul Gajski, to Morris Maxwell, Brother Brian, Dennis, Rob Croll, Dianne & Doug DuFresne, Leonie Metzakis,Brian Kemp, Kevin Moran, Roger Perry, Bruce & Kay Carter, Shirley and Gary Broadbents , tent sales and auction help. Then there is the Aussie team shuttle drivers and the field helpers. Sorry if I missed someone but all I know is the field markers were brought over by me. THANK YOU AUSTRALIA & FELLOW BOOMERANGERS >>>come on back<<< Stuart Jones (STU-ee my international ID)

 Editor's Note - Stuart Jones

brought his video camera and taped almost everything he could see during the competition. Stuart is making these tapes available to the readers at a dynamite low price of \$3/tape. Each of the 3 tapes is packed with World Cup coverage. You get 14 hours of boomeranging fun for only \$9 + shipping.

Tape one: 6 hr's.-- Seamist Tourny ,12 Apostles, animals & sounds,opening ceremonies, awards banquet, King Billy Hook, wind decision, individual Aussie round, some auction, indoor championships.
 Tape two: 6hr's.-- cont. indoor championships, bus ride & the Healesville Sanctuary, rain forest, individual awards, sounds ,funfly GLORP, juggling.
 Tape three: 1hr. 45 min.-- cont. juggling, whoa nellie, blind Merrisa with rangs,GLORP, Bruce Carters home walk-a-bout, air-planes and finally home with Karen & Boomie.

The mailing cost of the 3 NTSC format condensed tapes in the US is \$3.25, Overseas \$16.50. You can call or Fax: 651-228-1393 or email circlestixstuk@webtv.net or write to:



Harald Steck Receiving His Award

Stuart N. Jones
195 E. 5th St. Apt. 605
St. Paul, MN 55101-1949

Kristopher Shrewsberry (Canton, OH) took 1,755 pictures at the World Cup with his digital camera. You can purchase a CD with all of the photos for only \$15.
 Email: RoadRnnr@NEO.RR.com

Web sites where you can find photos and coverage of the 2000 World Cup are listed below:

<http://www.boombastic.de.st/>

<http://www.fixaframe.com.au/worldcup/worldcup.htm>

<http://stud.fh-wedel.de/~mi3359/wc2000/>

Team Tournament Overall Results

Place	Team	Points
1	Young Guns (GER)	208.5
2	Turtle Tribe (USA)	203.5
3	Wild Cards (USA)	182
4	Knochen (GER)	165.5
5	Pirate 1 (FRA)	146.5
6	Samurai (JP)	138
7	Switzerland	125.5
8	Fever 1 (AUS)	123
9	No Mercy (GER)	108.5
10	Boom Brothers (USA)	94.5
11	Fever 2 (AUS)	85
12	Pokemon (JP)	65.5
13	France 2	61
14	Snowbirds (CAN)	57
15	International Women	36

Long Distance Tournament

Place	Thrower	Points
1	Manuel Schütz (SUI)	199 m
2	David Schummy (AUS)	131 m
3	Gary Broadbent (USA)	130 m
4	Renan Guillou (FRA)	111 m
5	David Hesse (SUI)	108 m
6	Luc Bordes (FRA)	75 m
7	Harald Toft (DAN)	56 m

Individual Tournament
(Top 30 Overall - 97 Throwers)

Rank	Thrower	Points
1	Manuel Schütz	46.5
2	Adam Ruhf	58.5
3	Harald Steck	70
4	Mike Gabriel	71.5
5	Casey Larrance	97
5	Fridolin Frost	97
7	Oli Thienhaus	104.5
8	Steven J. Kavanaugh	109.5
9	Nobu	111
10	Thomas Szartowicz	125.5
11	Chet Snouffer	132
12	Gregg Snouffer	142
13	Yves Caze	143
14	Maiya Junji	150.5
15	William G. Gix	156.5
16	Jason Smucker	162
17	Taketome Haruki	162.5
18	Christian Meyer	165
19	Alexander Opri	167
20	John Gorski	167.5
20	Ian Sproul	167.5
22	Mark Weary	173.5
23	Axel Heckner	177.5
24	Sascha Winkler	180.5
25	Sebastien Guiheux	182
26	Torsten Fredrich	183
27	Gary M. Broadbent	187
28	Guenter Moeller	197.5
29	Stuart Jones	198.5
30	Jean-Luc Villani	199

Fast Catch - Top 10 Throwers

Thrower	Time	Place
Manuel Schütz	37.58	1
Frederic Declercq	37.71	2
Murayama Yoshiyasu	40.72	3
Casey Larrance	43.89	4
Sebastien Guiheux	45.71	5
Christian Meyer	46.13	6
Stephane Marguerite	46.89	7
Steven J. Kavanaugh	48.18	8
Harald Steck	48.19	9
Adam Ruhf	53.26	10

Endurance - Top 10 Throwers

Thrower	Catches	Place
Adam Ruhf	64	1
Chet Snouffer	62	2
Manuel Schütz	61	3
Fridolin Frost	59	4
Eugene Cinal	56	5
Oli Thienhaus	55	6
Mike Gabriel	55	6
Nobu	54	8
Alexander Opri	54	8
Thomas Szartowicz	51	10
Maiya Junji	51	10
Gregg Snouffer	51	10
Sascha Winkler	51	10
Mark Weary	51	10

MTA100 - Top 10 Throwers

Thrower	Time	Place
Harald Steck	40.07	1
Stuart Jones	39.13	2
Togai Yasuhiro	39.02	3
Chet Snouffer	37.65	4
Oli Thienhaus	37.62	5
Torsten Fredrich	37.37	6
Nobu	36.18	7
Aaron McGuire	36	8
Adam Ruhf	34.84	9
Oliver Rau	34.82	10

Aussie Round - Top 10 Throwers

Thrower	Points	Place
Adam Ruhf	89	1
Sascha Winkler	83	2
Mike Gabriel	79	3
Casey Larrance	77	4
Gary M. Broadbent	76	5
Guenter Moeller	76	5
Oli Thienhaus	74	7
Alexander Opri	74	7
Mittelette	73	9
Harald Steck	72	10

Accuracy - Top 10 Throwers

Thrower	Points	Place
Mike Gabriel	41	1
Steven J. Kavanaugh	39	2
Murata Hiroyuki	39	2
Taketome Haruki	37	4
Stuart Jones	36	5
Mark Weary	35	6
Axel Heckner	34	7
Manuel Schütz	34	7
Robert Burwell	33	9
Christian Meyer	33	9

Trick Catch - Top 10 Throwers

Thrower	Points	Place
Fridolin Frost	162	1
Harald Steck	98	2
Manuel Schütz	90	3
Mike Gabriel	87	4
Gregg Snouffer	85	5
Maiya Junji	83	6
Adam Ruhf	81	7
Chet Snouffer	80	8
Oliver Rau	78	9
William G. Gix	77	10
Togai Yasuhiro	77	10

Prehistoric European Boomerangs

It is well known that boomerangs were used in Northern Europe as recently as 2,000 years ago. Lorin Hawes mentioned this in his famous boomerang book and numerous articles have appeared in back issues of MHR and Boomerang News. The oldest known throwstick was made in Poland out of Mammoth tusk 20,300 years ago. I have just received word that a 60,000 year old throwstick made out of hardwood has recently been recovered in Germany. Verification of this is currently underway. If this is indeed true, there will be some mighty unhappy Aborigines who claim to be the original inventors.

Heikki Niskanen recently sent in some rather interesting material. The Hunting Museum of Finland publishes "The Magic of Image" newsletter. In a recent issue there was an article concerning Scandinavian boomerangs.

The article spoke about Shamans and how they used "animal-head-sticks" in their rituals. These sticks were boomerang shaped devices and some resembled horse headed sticks. With these sticks, the shaman could fly to lower or unknown worlds.

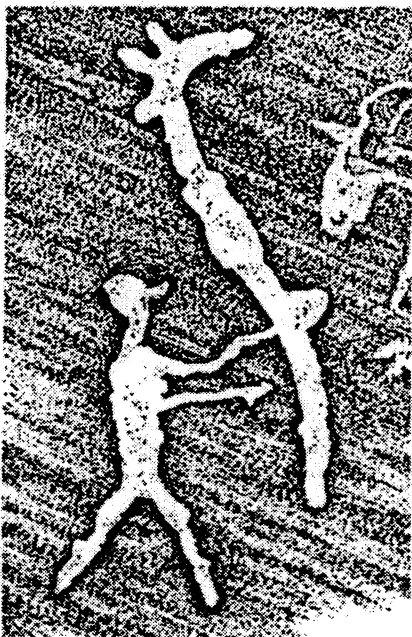

The shaman animal head sticks are drawn much larger (relative to the body of the shaman) than they were in real life. These sticks were often made of bone or antler and had a physical length of 28-35 cm.

The shamans would hold on to their sticks and their soul would leave their body and fly into the lower world to beg the lord of the animals (an enormous Elk) to replenish the game that the hunters killed for food. They did this while the tribe was engaged in ritual dancing. Magic sticks have been recovered from the graves of shamans where they were used as burial gifts. A valuable trove of these were found on the isle of Oleni Ostrow in Lake Onega.

The animal-head sticks were not returning boomerangs, but in Northern Sweden (Ångermanland), there are petroglyphs that date from 4,000 BC - 3,000 BC that show boomerang devices shaped like a sickle or scythe before farming was practiced in this region. The boomerangs are referred to as "returning cult-wood" objects and were considered to be enchanted objects that always returns when you throw them away. The Hunting Museum of Finland made replicas of 7 sticks, as depicted by the drawing below. All the sticks were hook shaped, except for a single triblader. All of the repli-

Boomerangs of Nämforsen

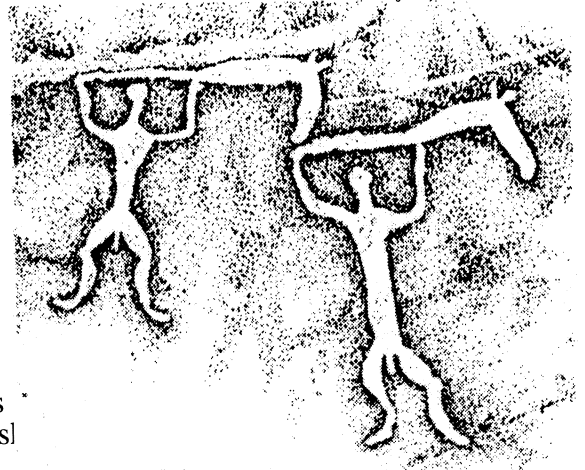
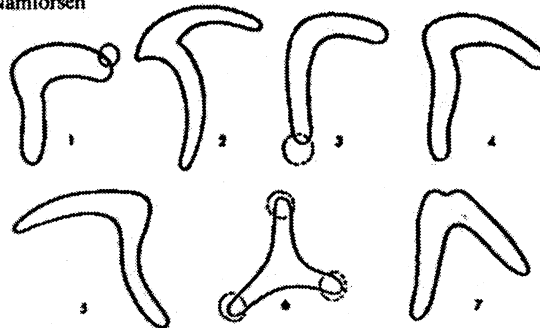

cas were capable of a return flight except for shape #1. The editor questions the airfoiling assumptions used in the construction of the replicas as this detail is not available in the petroglyphs. Have actual returning boomerangs been found in Scandinavia? Let the readers hear more about this if you have any additional information.

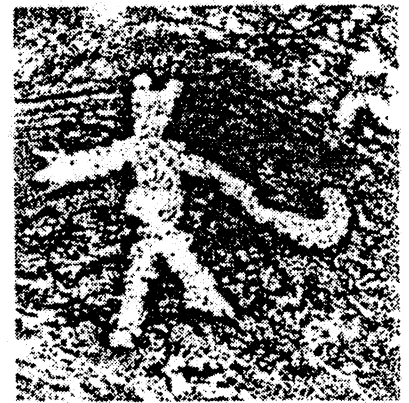

Electronic Boomerangs - Flashing LEDs

by Steve Smythe (United Kingdom)

email: smyths@liyorkrd.li.co.uk

An astable multivibrator circuit gives a simple and efficient means of flashing two LEDs. Surface-mount (SMT) components give a lightweight means of making the circuit and the lithium cell CR1220 weighs 0.9 Gram. The total weight of the components is less than three Grams and is feasible for MTA applications.

Find the centre of rotation of the boomerang and use Blu-Tac or similar to simulate the weight of the lithium cell and the SMT components before installation. The circuit and the lithium cell must be mounted on the boomerang so as not to change the position of the centre of rotation. A channel to take the wires from the circuit to the wing tips is cut into each arm of the boomerang. A twisted pair of 32 SWG or thinner enameled copper wire is suitable. Epoxy adhesive is used to hold the wires in each channel. Attach a strip of self adhesive aluminium tape (17mm x 25mm) and place the lithium cell on the tape with the +ve side down. Use epoxy adhesive to hold the lithium cell in place. Make sure the epoxy adhesive does not flow over the edge of the tape and onto the boomerang.

The strip of aluminium tape makes the +ve terminal for the circuit. An excess length of the tape is used to ease replacement of lithium cells. The tape with the spent lithium cell on it can be cut with a sharp knife and lifted off. Replaced cells are bonded to a new piece of aluminium tape that is linked to the remaining length of the original piece of the tape. See Fig. 3.

Low current miniature LEDs that have a 0.1 inch lead pitch are used. Drill a hole near each wing tip for the LED. The LEDs point downwards and epoxy adhesive is used to mount them.

The circuit diagram is given in Fig. 1. With the timing circuit resistor and capacitor values shown (R2-C1 & R3-C2), the LEDs will flash at 55Hz. approx. With the collector resistor values at 1k5 (R1 & R4) the current consumption of the circuit is 1mA approx. and the lithium cell will last for 35 hours. Lower resistor values could be used to make the LEDs brighter at the expense of battery life.

A possible layout is given in Fig. 2. Cyanoacrylate adhesive is used to hold the SMT components to the boomerang before soldering. When the components are connected, use a stiff brush dipped in acetone or a similar solvent to remove any flux residue. Coat the components with epoxy adhesive to fix them permanently.

Hints & Tips. Use a hair drier to warm the boomerang

and the epoxy adhesive before application to the SMT components. Heat will make the epoxy adhesive less viscous and result in a lower profile and a faster cure time. Do not warm the boomerang when you fix the enameled copper wire in each channel, the wire will expand and lift out of the channel. Use a very fine bit in a temperature-controlled soldering iron at 700 °F. Twenty-six SWG PTFE insulated silver-coated copper wire or 26 SWG enameled copper wire is suitable for connecting the SMT components together. With care, a pair of tweezers and a magnifying glass the circuit can be built on the area of half a postage stamp or less. All soldered connection should be thinly coated with epoxy adhesive.

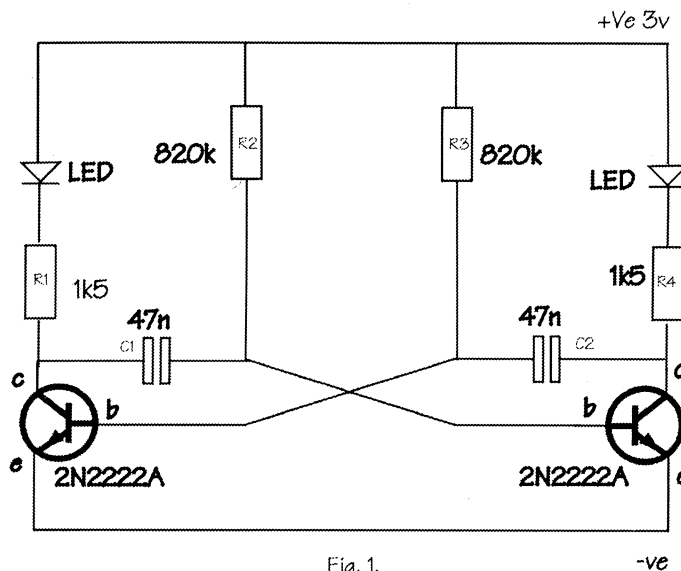

Fig. 1.
Astable multivibrator

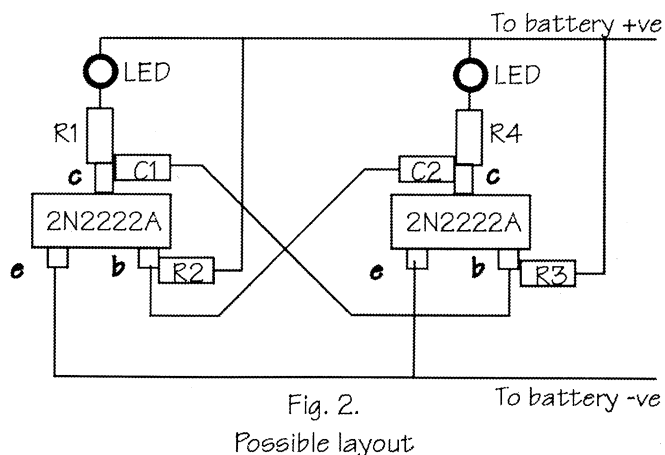

Fig. 2.
Possible layout

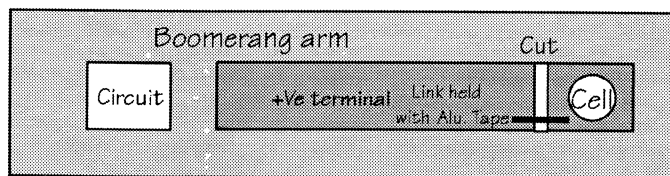

Fig. 3.



WBA Minutes 2000

A meeting was held on 2/10/00 at LaTrobe University in Melbourne, Australia with WBA Board members Chet Snouffer, Rob Croll, and Gunther Moeller present. Absent were Ted Bailey and Yoshi Sakimitsu. Yoshi sent information re: several proposals which were received. Also in attendance at this meeting were: Paul Gajski, Doug DuFresne, Dennis Maxwell, Morris Maxwell, Jason Smucker, Kevin Moran, Nobu Iitsuka, Kendall Davis. Many others came in towards the end of the meeting and were brought up to speed by Chet Snouffer.

1. Meeting was called to order by Chet Snouffer. It was agreed that there was a quorum present of 3 of the 5 board members assigned in 1996 to organize the WBA into a working entity.

2. A motion was made by Chet Snouffer that the WBA board of directors be comprised of the presidents of the recognized national boomerang organizations worldwide, with 1 per country. Günter Möller seconded.

Discussion followed. It was discussed that this board should then appoint it's own Chairmen from amongst it's members once it is convened. It was also discussed that in the case where more than one "national" club may petition to officially represent that country,

the WBA board would consider bids from all interested clubs and decide which best would represent the country and designate that body as the official WBA rep from that country. It was also discussed that the board member could be the President or his/her designee. These topics were all agreed upon. The motion was passed 3-0.

3. A brainstorming session was held in an open forum to discuss what the duties of this WBA board should be. Ideas included:

A. Review proposed bylaws and accept, modify or reject them. Formulate the bylaws which will be used to govern.

B. Sanction and schedule world and international competitions.

C. Recognize national organizations (as mentioned above in first motion)

D. Establish the rules of competition for international and world cup competition.

1. Include conditions for cancellation or re-scheduling of events due to weather, etc. This was a problem in Australia where winds gusted over 40 mph, leading to postponement of events, which were later completed the following day. It was noted that no specific standards were in the rulebook presently used. To remove this responsibility from TD's shoulders, these standards should be defined.

***These rules could be adopted by the national organizations as their official rules, but this would not be mandatory. To encourage continued development and originality in the events, the countries are free to consider various formats, and events, but all would know that the international rules will apply at all international and world cup events.

E. Establish guidelines to host a tournament. The board would contact TD's world wide and prepare checklists or guidelines for hosting in-

ternational tournaments. Subjects to be addressed would include Food, housing, transportation, toilets, T shirts, bags, patches and other amenities, organization of events, field requirements, rain dates, preparing and implementing budget, organizing workers, officials, TD, MEDIA GUIDE to promoting the sport. Formulate an officials handbook. This information would be available to member organizations and be used to upgrade the standards worldwide.

A motion was made by Chet Snouffer to approve these guidelines and present them to the new WBA board as a starting point for their expected responsibilities. Seconded by Günter Möller and approved 3-0.

After further discussion it was agreed that the national organizations and their presidents should be contacted and informed that they will now comprise the WBA board. Since Chet Snouffer is currently on the interim board of 5 and is USBA present for this term, placing him on the new board, he would take responsibility to organize this board initially and get them to the gate. The board can then elect a chairman or president and start with by-laws and duties.

postsript: It was discussed that the WBA's initial emphasis is to organize and oversee international competition. Recognizing that this is only one small aspect of boomerang activity (others including collecting, design, recreational throwing, history, promotion, preservation, etc.) the WBA will work to compile information on these aspects as well, but it needs to start with standardizing the sport itself for international recognition.

Respectfully submitted 2/28/00 by Chet Snouffer for the WBA

USBA Calendar of Events

regularly updated on the web at: <http://www.usba.org/calendar.html>

- May 20: Toss Across America at a field near you; Betsylew Miale Gix; betwil@wa.freei.net; 425-485-1672
- May 27-29: 13th Annual Gateway Classic, St. Louis, MO; Tom Fitzgerald; Fitzreturn@aol.com; 314-839-1604
- June 24-25: Twin Peaks Tournament, North Bend, WA; Will Herlan; blugar@gte.net; 425-883-3231
- July 1-3: 6th Annual Indiana Open, Indianapolis, IN; Tony Brazelton; brazelami@yahoo.com; 317-883-2334
- July 9: 13th West. Oregon Boom Roundup, Salem, OR; Dean Kelly; Dean.A.Kelly@state.or.us; 503-581-8050
- July 15: National Team Boom Fest, Amherst, MA, Larry Ruhf; ruhfhouse@the-spa.com; 413-323-4340
- July 29: Burlington, VT, Paul Gustafson; FatElvis@together.net; 802-859-3430
- Aug 5-6: Free Throwers, Delaware, OH, Chet Snouffer, Leadingedgechet@columbus.rr.com, 740-363-8332
- August 11-13: US Open, Canton, OH, Gary Broadbent, Broadboom@juno.com, 330-492-RANG
- 9/10 September: 4th Annual Outer Banks Comp; Amy Thompson; events@kittyhawk.com; 877-359-8447 x. 18
- mid September: central CT: Keith Mullinar, C_K_Mullinar@fleet.com ; 860-568-6008

USBA Board Email Contact Info

President Chet Snouffer - usba@usba.org
Vice-President Fred Malmberg - usba@usba.org
Treasurer Steve Cook - membership@usba.org
Secretary Betsylew Miale-Gix - betwil@wa.freei.net
Billy Brazelton - braz0026@tc.umn.edu
Eric Darnell - tpi@together.net
Keith Mullinar - C_K_Mullinar@fleet.com
Larry Ruhf - RUHFHOUSE@aol.com
Pat Steigman - psteigman@tyler.net

Other USBA Email Contact Info

MHR Editor: Ted Bailey - tbailey@ic.net
Web Page: Tony Brazelton - brazelami@yahoo.com

Don't forget to notify Tony and Ted about your boom event so the info can be added to the internet and newsletter calendar of events.

The Board has organized several committees in order to divide up the work load and set specific goals. Pat and Keith are heading up the promotional committee, which will run the USBA store and explore promotional strategies including the creation of a USBA educational/promotional video and possibly hiring a videographer to cover the Nationals on August 11-14. If you have skills, experience, or interest in these areas please contact Pat or Keith.

A Partnership Committee has been formed by Betsylew and Keith with the goal of establishing relationships with corporations, businesses, and organizations willing to sponsor USBA events or participate in mutual promotional endeavours. We are currently contacting Outback Steakhouses, the Boy and Girl Scouts, and Team Kanga. Any ideas or suggestions are always welcome.

A Grass Roots Membership Development Committee is being led by Larry and Pat. They will concentrate on advertising and encouraging participation in the sport on the local level and develop programs for this purpose. A boomerang educational package for classroom use is currently being developed. If you have any materials or are willing to help us out with this project, please contact us at the email addresses to the left.

The United States Boomerang Association

USBA INFORMATION

The USBA is a non-profit organization whose goal is to promote the art, craft and sport of boomerangs through events, competitions, and information distributed through the quarterly newsletter, Many Happy Returns. Your input is welcome. You can contact the USBA by writing to:

U.S. Boomerang Association
1868 Panhandle Road
Delaware, OH 43015

Phone or Fax: (740) 363-4414

E-mail:

Internet: <http://www.usba.org>

USBA BOARD OF DIRECTORS

President

Chet Snouffer (740) 363-8332

Vice-President

Fred Malmberg (717) 848-4601

Treasurer

Steven Cook (912) 644-7449

Secretary

Betsylew Miale-Gix (425) 485-1672

Directors

Billy Brazelton (651) 905-9550

Eric Darnell (802) 765-4336

Keith Mullinar (860) 568-6008

Larry Ruhf (413) 323-4340

Pat Steigman (903) 581-5556

Comments on newsletter content, and submissions for inclusion, including articles, photos, cartoons and designs should be submitted to the editor at the address below. The editor reserves the right to edit all material. Inclusion is not guaranteed. The deadline for newsletter submissions is March 1, June 1, September 1 and December 1 for the Spring, Summer, Fall and Winter issues respectively.

Ted Bailey
P. O. Box 6076
Ann Arbor, MI 48106

email: tbailey@ic.net
phone: (734)-971-2970

USBA MEMBERSHIP INFORMATION

All membership dues should be paid by check or money order in USD\$. Make checks payable to: USBA.

Domestic and Canadian annual membership dues are \$15 per year. A domestic lifetime membership is \$225. Annual overseas dues are \$20. A lifetime overseas membership is \$350.

Check your newsletter label for expiration issue. Membership status questions should be directed to **Steven Cook**

Many Happy Returns

Circulation: 300 Worldwide.

Published by the:

U. S. Boomerang Association
1868 Panhandle Road
Delaware, OH 43015

Mechanical Measurements:

Image area: 9.5" deep by 7.5" wide; 3 columns to a page;
width of a single column: 2.25"

Advertising Rates:

Full Page	\$100
2 Columns	\$ 75
1/2 Page	\$ 60
1 Column	\$ 50
Per Column inch	\$ 5

10% discount for 4 consecutive issues. All advertisements must be pre-paid in USD by check or M. O. to USBA. Camera-ready copy preferred. The editor reserves the right to refuse any advertisement or cancel a contract without reason. The deadline for all advertisements is March 1, June 1, September 1 and December 1 for the Spring, Summer, Fall and Winter issues respectively. All advertisements should be mailed to: **Ted Bailey; P. O. Box 6076; Ann Arbor, MI 48106**

Membership Application

Copy this page and carry extra copies of this sheet in your boomerang bag to hand out.

Check: New Renewal

name

address

address

city/state/zip or country

phone number (optional)

New Member or Renewal?

USBA member sponsor's name

New members and renewals: Send the completed coupon (or copy) and \$15 (\$20 overseas) check or M. O. to:

USBA Membership
Steven Cook, Treasurer
322 West Park Ave. Apt. B
Savannah, GA 31401-6423



www.usba.org

United State Boomerang Association
Membership Office
Steven Cook, Treasurer
322 West Park Ave. Apt. B
Savannah, GA 31401-6423

912 732 090 000612 09:18

POSTAL SERVICE

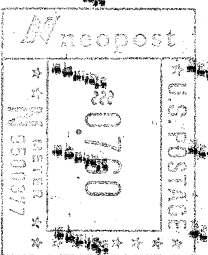
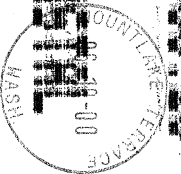

AIR MAIL

85
Andy A. Cross
50 Falshire Terrace NE
Calgary Alberta T3J 3B3 Canada

Renew Now
if the number by
your name is 78!