

# Many Happy Returns

Issue No. 57

An International Publication of the United States Boomerang Association

Winter 1994

## MARK WEARY SETS NEW AUSSIE ROUND

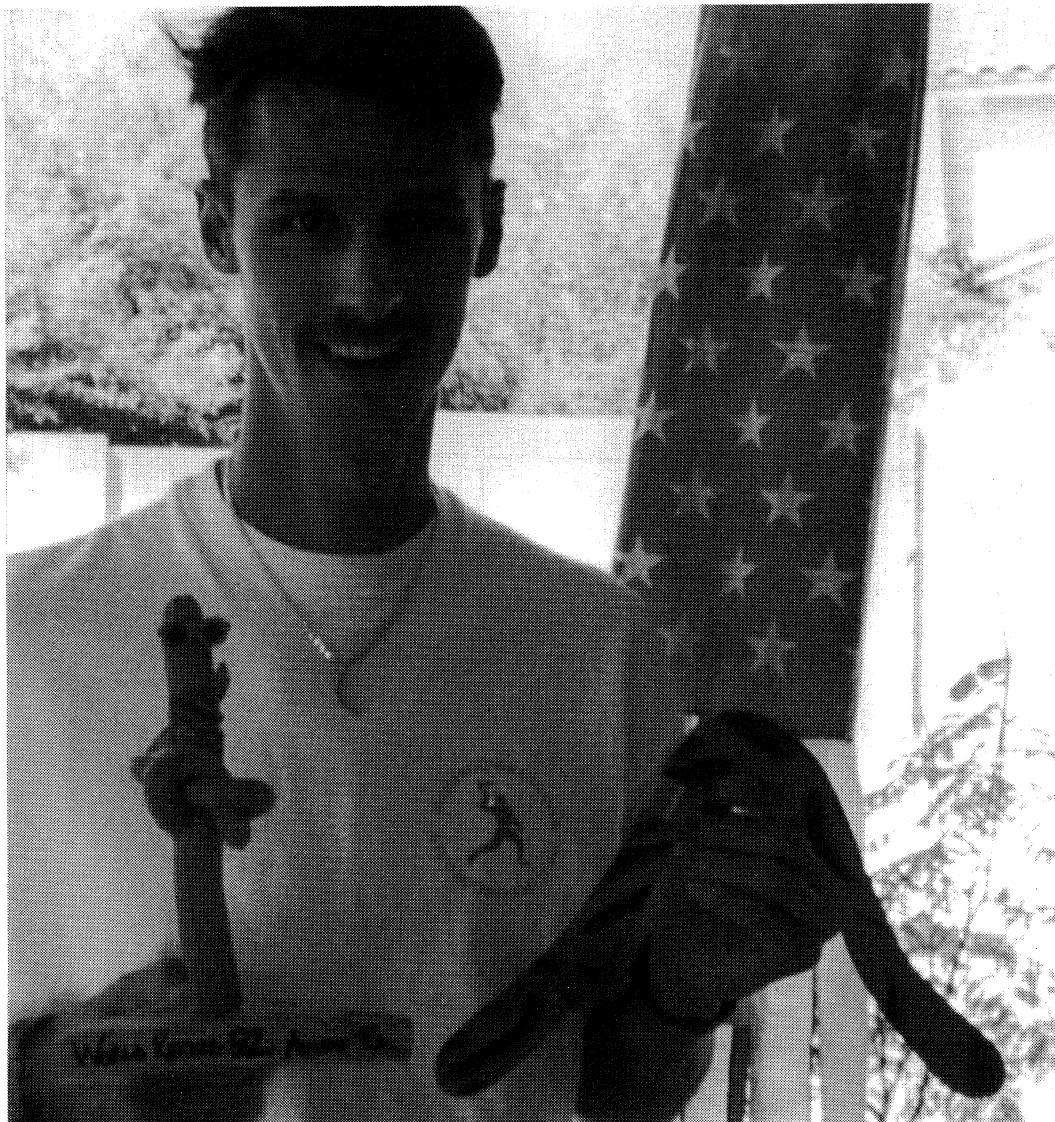

**WORLD RECORD WITH AN INCREDIBLE 92!**



## ★ President's Column ★

Not too long ago Will and I had the opportunity to throw in a thick fog at twilight at our favorite field. We tentatively warmed up using our shortest rangs which were barely discernible in the gloom. On impulse, I pulled out a weighted version of our windsong, a forty meter boom, and launched it boldly into the murk. A few meters out it disappeared as it climbed into the ever thickening fog. Turning confidently in the anticipated direction of its return I was rewarded with its sudden appearance several feet above me nearby. There was something so magical in throwing a boomerang, having it disappear into the fog, then after seconds of anxious waiting re-appear as if by magic above me, that I had to do several more times.

There was no great technical expertise involved. There was no score achieved. Yet it was one of the most intriguing and satisfying boomerang experiences I have had in a long time. The moral of the story is that we can get so caught up in all our art, technology, and competition that we forget the basic magic and pleasure of what we do.

I hope the holiday season has found you all healthy, thankful for what has been, and looking forward to what will be. Remember, it is not too late to give that special someone a gift membership in the United States Boomerang Association. Better yet, what a more novel gift could there be for your co-workers and friends. Who knows, some of them might get interested enough to obtain boomerangs, make boomerangs, and get involved! If you do not receive this until after christmas, no matter, there will always be another occasion.

The board is implementing a 900 telephone number which will provide info, enlightenment, and tournament schedules for a nominal fee per minute. More details will follow in the next issue.

I was disappointed in the response to the call for membership participation on the committees. Thank you Paul Sprague, who will be serving on the membership committee, and Will Gix, who will be serving on the team selection committee.

We are hoping to implement a balloting system which will allow for more candidates to run for the board and officer positions, as well as allow for mail balloting by the general membership. The next MHR will contain a brief description of what the positions do and information on how you can submit your name, the position for which you wish to run, and a brief statement of your qualifications or reasons by a certain date to be included on the ballot. This information will be forwarded to the membership so that anyone who wishes to vote can participate, and not just those who attend the nationals.

Preliminary word is that a bid being put together by Bud Pell for a Labor Day Nationals.

BETSY

### *What's In This Issue!*

Page	Contents
2	President's Column
3	USBA Store
3	Future New Features
4	1993 Comp. Ratings
8	Bits and Pieces
14	SuperCatch Honor Roll
15	World Records
16	Free Thrower's Comp
16	USBA Nationals
17	USBA Open
18	Phoenix Comps
19	USBA Information

### TRADE

or for sale



Boomerangs fully tuned, signed and stamped will trade for Books, Literature and will trade Boomerangs for Boomerangs – **TELL ME WHAT YOU HAVE!**

Contact: John Cryderman  
136 Thames Street, Chaham  
Ontario, Canada N7L 2Y5  
519-354-3984 Fax 519-351-8345

# The USBA Store

The USBA Store is open for business! Where else can you find a broad selection of boomerang books and paraphernalia.

I'm always looking for new items that will be of interest to our members. Send me your suggestions for what you'd like to see here. I've already received some suggestions and am looking into them now.

All proceeds from sales will go directly toward store operating expenses and the support of the USBA as a whole. This makes buying stuff from the store of double benefit to you! You not only get top quality merchandise at outstanding prices, but you also support the USBA!

All checks and money orders should be made out to **Dean A. Kelly**. Make sure to clearly state the items wanted for each order.

For a complete list of what is currently available in stock, send a SASE (USA) or \$1 (overseas) to:

**The USBA Store  
C/O Dean A. Kelly  
3350 Neef Ave. SE  
Salem, Or. 97302**

Questions? Call: (503)-581-8050

All prices are in \$USA\$ and include Shipping and Handling to the USA or Canada. Overseas orders must include \$2 extra for surface or \$4 extra for Air-mail per item. Back issue newsletters are \$1 additional for surface mail and \$2 extra for Airmail.

## USBA Store Stock Availability - Prices Each Item:

\$3.50	USBA Embroidered Patches
\$1.50	USBA Mylar Decals
\$6.00	"Boomerang": a book by Ben Ruhe
\$8.00	"The Big Book About Boomerangs": a book by H. L. Mayhew*
\$4.00	"The Boomerang": an early pamphlet by B. Ruhe/L. Hawes
\$20.00	Huerer Swiss Digital Stopwatch**
\$15.00	USBA T-shirts available in sizes: M, L, XL color: gray
\$12.00	USBA '93 Open T-shirts available in size L only color: gray
\$2.50	Back Issues of MHR: # 21-W85; #23-Sm86; #26-Sp86; #27-Sm86; #28-F86; #29-W87; #31-Sm87; #32-F87; #33-W88

\* First edition and signed by the author.

\*\* high quality Swiss made. A \$50 value. Only 4 in stock.

Orders of \$15 or more are eligible for a free issue of MHR. Please indicate your first and second choices.

## New features for the future by Chet Snouffer, Competition editor

Boom chuckers! Remember to send all tournament results and write-ups to me at the PO Box 182, Delaware, Ohio 43015 for inclusion in future MHR newsletters. Each MHR will have 4 pages set aside for competition items so my job will be to digest what you send and format it to get the most information out and about.

Mark Weary and I discussed a **Question and Answer Column** for future issues. This can include questions on throwing technique, design, history, competition, art, sport, science. Address it to me at the PO Box. I will send you query to the "expert" on that topic and include their response in a future issue. **Who** is the Boomerang Man? **How** do you get a diving boom to stay up? **Where** does Barnaby live this week? **What** should I throw for MTA in a 12 mph breeze from the SW?" All this and more can be yours by merely asking! Get on it!

Til next issue, full circles. - Chet

## NEW 1994 FULL COLOR CATALOG.

### 10th Anniversary of Gel Boomerangs.

**New designs.**

**Beginner to Expert boomerangs.**

**Beginner, Intermediate and Competition sets.**

**Six different throwers have set**

**Nine World Records with Gel Boomerangs.**

**Beautiful Finishes...Superior Performance**

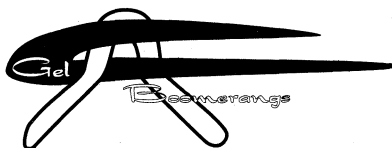

SEND FOR FREE FULL COLOR CATALOG

GEL BOOMERANGS

2124 KITTREDGE STREET #61  
BERKELEY, CALIFORNIA 94704 USA

(510) 658-2469

# 1993 United States Boomerang Association Overall Competition Rankings

NAME	TC	ACC	FC	AUS	MTA	DOUB	END	JUG	TOTAL
CHET SNOUFFER	20	20	20	20	19	19	20	20	158.00
MICHAEL GIRVIN	14	13	18	18	16	20	13	18.5	130.50
JOHN FLYNN	12	16	19	10.5	18	7		18.5	101.00
MARK WEARY	16	14	12.5	19	1.5	16		17	96.00
GREGG SNOUFFER	18	12	17	13		14	18	1	93.00
GARY BROADBENT	11	5	5	15.5		17	19	15.5	88.00
DOUG DuFRESNE	19	15	9	9	13	10.5	12		87.50
STEVE KAVANAUGH	13	4	14	17		12	14.5	10	84.50
CHICAGO BOB	17		12.5	6	10	13	11		69.50
BARNABY RUHE	3	19	1	3	11.5	9	7	15.5	69.00
MIKE DICKSON	9		10		6	15	17		57.00
STEPH. MARGUERITE	3		2	10.5		10.5	16	13	55.00
JOHN KOEHLER	15		11	2		3.5	8	13	52.50
CASEY LARRANCE	5	17		15.5		5		6	48.50
ADAM RUHF	6.5	18	7		3			11	45.50
MOLEMAN	8				8	8		7.5	31.50
ERIC DARNELL		2	16	4.5	9				31.50
JASON KRAUSE	10				20				30.00
ALLEN GRINDLE				12		1		13	26.00
SCOTT BARRETT		9	15						24.00
BYRON SEWARD					4.5	18			22.50
WILLIE DAVIS					15		5		20.00
JOHN GORSKI	3			1			14.5		18.50
WILL GIX		2		8		6		2	18.00
M. GIESENSCHLAG			8				10		18.00
KIM GALEAZZI					17				17.00
PETER RUHF		2			14				16.00
SEAN MARQUARDT	1			7	7		0.5		15.50
PAUL SPRAGUE	6.5	8							14.50
JAY EMERSON		10			4.5				14.50
ALAN WINTERROWD				14			0.5		14.50
BOB FORESI					11.5				11.50
JIM YOUNGBLOOD		6.5		4.5					11.00
CHARLIE KUNKEL		11							11.00
ED CARRIGG						3.5	6		9.50
T W SMITH								9	9.00
BRIAN JACKSON							9		9.00
BETSY MIALE-GIX			6			2			8.00
DAVE CHAVEZ								7.5	7.50
JONAS ROMBLAD							2	5	7.00
SCOTT CREECH		6.5							6.50
JAMES JORDAN							3	3.5	6.50
KEN FARR							4		4.00
PAUL DAVID								3.5	3.50
LARRY RUHF			3.5						3.50
DENNIS JOYCE			3.5						3.50
PETER GIBSON					1.5				1.50
									0.00
	210.00	210.00	210.00	210.00	210.00	210.00	210.00	210.00	1680.00

ROAD WARRIORS:	CHICAGO BOB	8 contests
	DOUG DuFRESNE	8
	JOHN GORSKI	8
	STEVE KAVANAUGH	8
	MARK WEARY	8
	KELLY ANDRETTI	6
	BETSYLEW MIALE-GIX	6

1993 U. S. B. A. RATING SYSTEM RESULTS COMPILED BY J. FLYNN AND A. WINTERROWD

FOR EACH OF THE 8 RATED U. S. B. A. EVENTS:

**BEST SCORE:** (1 tournament result required to qualify) – Throwers' BEST score in an event.

**MEDIAN SCORE:** (3 tournament results req'd to qualify) – If odd # scores, the MIDDLE score in the event.  
If even # scores, the AVERAGE of the two MIDDLE scores.

**PLACING AVERAGE:** (2 tournament scores req'd to qualify) – The SUM of all Placing Points earned in the event, divided by the NUMBER OF SCORES obtained in the event.

**TOTAL POINTS:** The SUM of all points earned in the 3 categories, with thrower earning highest number of points receiving 20 pts., 2nd highest – 19 pts., etc.... Ties split points.

**OVERALL RANKING:** The SUM of TOTAL POINTS for all 8 rated events.

**TRICK CATCHING**

BEST SCORE				MEDIAN SCORE				PLACING AVG				OVERALL			
PL	NAME	SCORE	PTS	PL	NAME	SCORE	PTS	PL	NAME	SCORE	PTS	PL	NAME	TOTAL PT	PTS
1	DuFRESNE	20	20.0	1	BOB	11.0	19.0	1	SNOUFFER	9.297	20.0	1	SNOUFFER	58.00	20.0
2	C SNOUFFER	19	19.0		G SNOUFFER	11.0	19.0	2	DuFRESNE	8.867	19.0	2	DuFRESNE	52.50	19.0
3	G SNOUFFER	18	17.5	3	C SNOUFFER	11.0	19.0	3	KOEHLER	8.667	18.0	3	G SNOUFFER	51.50	18.0
	C BOB	18	17.5	4	M WEARY	10.5	17.0	4	M GIRVIN	8.500	17.0	4	C BOB	49.50	17.0
5	M WEARY	17	16.0	5	J KOEHLER	10.0	13.5	5	M WEARY	8.467	16.0	5	M WEARY	49.00	16.0
6	J FLYNN	16	15.0		M DICKSON	10.0	13.5	6	G SNOUFFER	8.183	15.0	6	J KOEHLER	44.50	15.0
7	M GIRVIN	14	14.0		G BROADBENT	10.0	13.5	7	S KAVANAUGH	7.619	14.0	7	M GIRVIN	40.00	14.0
8	J KOEHLER	12	13.0		DuFRESNE	10.0	13.5	8	C BOB	7.311	13.0	8	S KAVANAUGH	34.50	13.0
9	R PARKINS	11	7.0		S KAVANAUGH	10.0	13.5	9	A RUHF	7.280	11.5	9	J FLYNN	34.00	12.0
	G BROADBENT	11	7.0		J KRAUSE	10.0	13.5		P SPRAGUE	7.280	11.5	10	G BROADBENT	29.50	11.0
	J GORSKI	11	7.0	11	M GIRVIN	9.5	9.0	11	J FLYNN	6.703	10.0	11	J KRAUSE	26.50	10.0
	M DICKSON	11	7.0		J FLYNN	9.5	9.0	12	G BROADBENT	6.668	9.0	12	M DICKSON	25.50	9.0
	E FIELDS	11	7.0		SMARQUARDT	9.5	9.0	13	K GALEAZZI	6.421	8.0	13	MOLEMAN	14.11	8.0
	A GRINDLE	11	7.0	14	MOLEMAN	9.0	3.1	14	C LARRANCE	6.407	7.0	14	P SPRAGUE	11.57	6.5
	J KRAUSE	11	7.0		C LARRANCE	9.0	3.1	15	J KRAUSE	6.005	6.0		A RUHF	11.57	6.5
	S MARGUERITE	11	7.0		S MARGUERITE	9.0	3.1	16	M DICKSON	5.920	5.0	16	C LARRANCE	10.18	5.0
	MOLEMAN	11	7.0		E CARRIGG	9.0	3.1	17	MOLEMAN	5.720	4.0	17	S MARGUERITE	10.11	3.0
	BRUHE	11	7.0		C KUNKEL	9.0	3.1	18	J JORDAN	5.390	3.0		J GORSKI	10.11	3.0
	S KAVANAUGH	11	7.0		D JOYCE	9.0	3.1	19	B SEWARD	5.370	2.0		BRUHE	10.11	3.0
20 (14 TIED WITH)		10	0.07		B GIX	9.0	3.1	20	S MARQUARDT	5.050	1.0	20	S MARQUARDT	10.07	1.0
					J GORSKI	9.0	3.1		M DeVITA	5.000		21	K GALEAZZI	8.07	
					BRUHE	9.0	3.1		J GORSKI	4.769		22	E FIELDS	7.00	
													R PARKINS	7.00	

**20 METER ACCURACY**

BEST SCORE				MEDIAN SCORE				PLACING AVG				OVERALL			
PL	NAME	SCORE	PTS	PL	NAME	SCORE	PTS	PL	NAME	SCORE	PTS	PL	NAME	TOTAL PT	PTS
1	DuFRESNE	44	20.0	1	BRUHE	37.5	20.0	1	C SNOUFFER	9.198	20.0	1	C SNOUFFER	57.00	20.0
2	C SNOUFFER	43	19.0		A RUHF	36.0	19.0	2	BRUHE	7.868	19.0	2	BRUHE	54.00	19.0
3	G SNOUFFER	42	17.5	3	C SNOUFFER	35.0	18.0	3	A RUHF	7.827	18.0	3	A RUHF	49.00	18.0
	J EMERSON	42	17.5	4	C LARRANCE	33.0	16.5	4	J FLYNN	6.650	17.0	4	C LARRANCE	47.50	17.0
5	BRUHE	41	15.0		J FLYNN	33.0	16.5	5	C LARRANCE	6.430	16.0	5	J FLYNN	36.00	16.0
	C LARRANCE	41	15.0	6	M WEARY	32.0	15.0	6	S CREECH	6.045	15.0	6	DuFRESNE	29.00	15.0
	J YOUNGBLOOD	41	15.0	7	M GIRVIN	31.0	14.0	7	M GIRVIN	6.000	14.0	7	M WEARY	28.50	14.0
8	A RUHF	40	12.0		C KUNKEL	30.5	13.0	8	S KAVANAUGH	5.959	13.0	8	M GIRVIN	28.00	13.0
	S BARRETT	40	12.0	9	E DARNELL	30.0	12.0	9	W GIX	5.833	12.0	9	G SNOUFFER	22.00	12.0
	P RUHF	40	12.0	10	MOLEMAN	29.5	11.0	10	M WEARY	5.721	11.0	10	C KUNKEL	21.00	11.0
11	S MARGUERITE	38	7.0		M DICKSON	29.0	8.5	11	T W SMITH	5.667	10.0	11	J EMERSON	19.50	10.0
	B OWEN	38	7.0		P DAVID	29.0	8.5	12	DuFRESNE	5.500	9.0	12	S BARRETT	16.50	9.0
	A GRINDLE	38	7.0		P SPRAGUE	29.0	8.5	13	C KUNKEL	5.483	8.0	13	P SPRAGUE	15.50	8.0
	P SPRAGUE	38	7.0		G BROADBENT	29.0	8.5	14	J JORDAN	5.390	7.0	14	S CREECH	15.00	6.5
	J GORSKI	38	7.0	15	K KENNY	28.0	4.5	15	C BOB	5.118	6.0		J YOUNGBLOOD	15.00	6.5
	B SEWARD	38	7.0		J GORSKI	28.0	4.5	16	G BROADBENT	4.973	5.0	16	G BROADBENT	13.50	5.0
	K GALEAZZI	38	7.0		S BARRETT	28.0	4.5	17	P GIBSON	4.833	4.0	17	S KAVANAUGH	13.00	4.0
18	J FLYNN	37	2.5		G SNOUFFER	28.0	4.5	18	W DAVIS	4.737	3.0	18	W GIX	12.00	2.0
	M WEARY	37	2.5	19	B JACKSON	27.5	2.0	19	J EMERSON	4.675	2.0		P RUHF	12.00	2.0
20	K FARR	36	0.3		W DAVIS	27.0	1.0	20	K GALEAZZI	4.643	1.0		E DARNELL	12.00	2.0
	N KERN	36	0.3	21	REV JIM	25.5		21	S BARRETT	4.608		21	J GORSKI	11.50	
	B JACKSON	36	0.3	22	D JOYCE	25.0		22	P RUHF	4.580		22	MOLEMAN	11.00	
					K FARR	25.0									
					N KERN	25.0									
					S MARGUERITE	25.0									

## FAST CATCH

BEST SCORE			MEDIAN SCORE			PLACING AVG			OVERALL						
PL	NAME	SCORE	PTS	PL	NAME	SCORE	PTS	PL	NAME	SCORE	PTS	PL	NAME	TOTAL PT	PTS
1	J FLYNN	18.95	20.0	1	C SNOUFFER	21.14	20.0	1	C SNOUFFER	9.560	20.0	1	C SNOUFFER	58.00	20.0
2	B GIX	19.14	19.0	2	E DARNELL	22.01	19.0	2	M GIRVIN	9.200	19.0	2	J FLYNN	50.00	19.0
3	C SNOUFFER	19.28	18.0	3	J FLYNN	22.69	18.0	3	M GIESENSCHLAG	9.000	18.0	3	M GIRVIN	44.00	18.0
4	J KOEHLER	19.60	17.0	4	M DICKSON	24.57	17.0	4	S BARRETT	8.837	17.0	4	G SNOUFFER	43.00	17.0
5	DuFRESNE	19.85	15.5	5	S BARRETT	25.12	16.0	5	S KAVANAUGH	8.344	16.0	5	E DARNELL	39.00	16.0
6	M WEARY	19.96	15.5	6	C BOB	26.28	15.0	6	G SNOUFFER	7.896	15.0	6	S BARRETT	33.00	15.0
7	G SNOUFFER	20.19	14.0	7	G SNOUFFER	27.59	14.0	7	J KOEHLER	7.785	14.0	7	S KAVANAUGH	32.00	14.0
8	M GIRVIN	20.98	13.0	8	S MARGUERITE	27.77	13.0	8	E DARNELL	7.717	13.0	8	M WEARY	31.50	12.5
9	S KAVANAUGH	21.34	12.0	9	M GIRVIN	28.75	12.0	9	J FLYNN	7.645	12.0		C BOB	31.50	12.5
10	B RUHE	21.50	11.0	10	L RUHF	29.53	11.0	10	M WEARY	7.604	11.0	10	J KOEHLER	31.00	11.0
11	A RUHF	21.56	9.5	11	MOLEMAN	29.62	10.0	11	G BROADBENT	7.305	10.0	11	M DICKSON	28.00	10.0
	C BOB	21.56	9.5	12	A RUHF	29.65	9.0	12	D DuFRESNE	7.168	9.0	12	D DuFRESNE	24.50	9.0
13	J YOUNGBLOOD	21.77	8.0	13	G BROADBENT	29.76	8.0	13	M DICKSON	6.628	8.0	13	M GIESENSCHLAG	23.00	8.0
14	E DARNELL	21.86	7.0	14	E CARRIGG	29.88	7.0	14	C BOB	6.230	7.0	14	A RUHF	19.50	7.0
15	D JOYCE	22.16	6.0	15	D JOYCE	30.54	6.0	15	L RUHF	5.907	6.0	15	B GIX	19.00	6.0
16	M GIESENSCHLAG	22.42	5.0	16	M WEARY	30.68	5.0	16	D JOYCE	5.887	5.0	16	G BROADBENT	18.00	5.0
17	C LARRANCE	22.55	4.0	17	S KAVANAUGH	31.85	4.0	17	P GIBSON	5.833	4.0	17	D JOYCE	17.00	3.5
18	M DICKSON	22.65	3.0	18	J GORSKI	32.22	3.0	18	C LARRANCE	5.813	3.0	18	L RUHF	17.00	3.5
19	W GIX	22.72	2.0	19	J ROMBLAD	32.78	2.0	19	A GRINDLE	5.760	2.0	19	S MARGUERITE	13.00	2.0
20	P RUHF	22.93	1.0	20	B SEWARD	32.84	1.0	20	A RUHF	5.190	1.0	20	B RUHE	11.00	1.0
21	G BROADBENT	22.99		21	D DuFRESNE	33.09		21	S MARGUERITE	4.985		21	MOLEMAN	10.00	
22	A GRINDLE	23.01		22	B RUHE	33.66			B SEWARD	4.985		22	J YOUNGBLOOD	8.00	
23	MOLEMAN	23.07													

## AUSTRALIAN ROUND

BEST SCORE			MEDIAN SCORE			PLACING AVG			OVERALL						
PL	NAME	SCORE	PTS	PL	NAME	SCORE	PTS	PL	NAME	SCORE	PTS	PL	NAME	TOTAL PT	PTS
1	M WEARY	92	20.0	1	G SNOUFFER	65.0	20.0	1	M GIRVIN	8.500	20.0	1	C SNOUFFER	54.00	20.0
2	W GIX	91	19.0	2	C SNOUFFER	64.0	19.0	2	C SNOUFFER	8.110	19.0	2	M WEARY	47.50	19.0
3	J FLYNN	83	17.5	3	A WINTERROWD	62.0	18.0	3	C LARRANCE	8.050	18.0	3	M GIRVIN	44.50	18.0
	C BOB	83	17.5	4	G BROADBENT	60.5	17.0	4	A GRINDLE	7.975	17.0	4	S KAVANAUGH	37.50	17.0
5	C SNOUFFER	80	16.0	5	C LARRANCE	59.0	16.0	5	D DuFRESNE	7.760	16.0	5	C LARRANCE	34.00	15.5
6	M GIRVIN	79	15.0	6	S KAVANAUGH	58.5	15.0	6	M WEARY	7.644	15.0		G BROADBENT	34.00	15.5
7	J YOUNGBLOOD	77	14.0	7	S MARGUERITE	58.0	14.0	7	A WINTERROWD	7.595	14.0	7	A WINTERROWD	32.00	14.0
8	A GRINDLE	74	12.5	8	B RUHE	57.0	12.5	8	G BROADBENT	7.587	13.0	8	G SNOUFFER	31.00	13.0
	S MARGUERITE	74	12.5		M WEARY	57.0	12.5		S KAVANAUGH	7.536	12.0	9	A GRINDLE	29.50	12.0
10	S KAVANAUGH	72	10.5	10	S MARQUARDT	56.0	11.0	10	B RUHE	6.633	11.0	10	J FLYNN	27.50	10.5
	J GORSKI	72	10.5	11	M GIRVIN	55.0	9.5	11	D JOYCE	6.288	10.0		S MARGUERITE	27.50	10.5
12	S JONES	71	9.0		M DICKSON	55.0	9.5	12	S MARQUARDT	6.135	9.0	12	D DuFRESNE	26.50	9.0
13	P MERCADO	70	8.0	13	J KOEHLER	54.0	8.0	13	J FLYNN	6.086	8.0	13	W GIX	25.50	8.0
14	E DARNELL	69	7.0	14	D DuFRESNE	52.0	6.5	14	G SNOUFFER	6.075	7.0	14	S MARQUARDT	20.25	7.0
15	G SNOUFFER	68	4.0		W GIX	52.0	6.5	15	J ROBERTSON	6.000	6.0	15	C BOB	17.50	6.0
	D DuFRESNE	68	4.0	16	E DARNELL	50.0	5.0	16	M GIESENSCHLAG	5.943	5.0	16	J YOUNGBLOOD	14.00	4.5
	B FORESI	68	4.0	17	B SEWARD	49.5	4.0	17	J KOEHLER	5.713	4.0		E DARNELL	14.00	4.5
	S CREECH	68	4.0	18	J FLYNN	48.0	2.0	18	L RUHF	5.657	3.0	18	B RUHE	13.50	3.0
	G BROADBENT	68	4.0		A RUHF	48.0	2.0	19	E DARNELL	5.567	2.0	19	J KOEHLER	12.00	2.0
20	S MARQUARDT	66	0.3		K GALEAZZI	48.0	2.0	20	S MARGUERITE	5.503	1.0	20	J GORSKI	10.50	1.0
	L RUHF	66	0.3	21	T W SMITH	47.0		21	D CHAVEZ	5.500		21	M DICKSON	9.50	
	P SPRAGUE	66	0.3									22	S JONES	9.00	
	B GIX	66	0.3												

## MAXIMUM TIME ALOFT - 100

BEST SCORE			MEDIAN SCORE			PLACING AVG			OVERALL						
PL	NAME	SCORE	PTS	PL	NAME	SCORE	PTS	PL	NAME	SCORE	PTS	PL	NAME	TOTAL PT	PTS
1	J KRAUSE	45.63	20.0	1	C SNOUFFER	36.59	20.0	1	C SNOUFFER	10.516	20.0	1	J KRAUSE	55.00	20.0
2	K GALEAZZI	41.97	19.0	2	E DARNELL	33.09	19.0	2	M GIRVIN	9.800	19.0	2	C SNOUFFER	54.00	19.0
3	D DuFRESNE	40.54	18.0	3	MOLEMAN	31.70	18.0	3	J KRAUSE	8.680	18.0	3	J FLYNN	46.00	18.0
4	S MARQUARDT	40.09	17.0	4	J KRAUSE	31.23	17.0	4	P RUHF	8.500	17.0	4	K GALEAZZI	42.00	17.0
5	B RUHE	39.37	16.0	5	J FLYNN	30.84	16.0	5	B FORESI	8.445	16.0	5	M GIRVIN	40.00	16.0
6	J FLYNN	39.32	15.0	6	M GIRVIN	30.78	15.0	6	J FLYNN	7.908	15.0	6	W DAVIS	33.00	15.0
7	C SNOUFFER	39.26	14.0	7	A RUHF	30.41	14.0	7	K GALEAZZI	7.230	14.0	7	P RUHF	27.00	14.0
8	B SEWARD	38.95	13.0	8	J EMERSON	30.30	13.0	8	P GIBSON	6.667	13.0	8	D DuFRESNE	26.00	13.0
9	B MIALE-GIX	38.76	12.0	9	W DAVIS	29.89	12.0	9	J ROBERTSON	6.500	11.5	9	B FORESI	23.00	11.5
10	W DAVIS	37.59	11.0	10	M DICKSON	29.80	11.0		D CHAVEZ	6.500	11.5		B RUHE	23.00	11.5
11	P RUHF	37.22	10.0	11	J ROMBLAD	29.72	10.0	11	W DAVIS	6.446	10.0	11	C BOB	20.00	10.0
12	G BROADBENT	35.57	9.0	12	K GALEAZZI	29.00	9.0	12	M WEARY	6.253	9.0	12	E DARNELL	19.00	9.0
13	L RUHF	35.40	8.0	13	C BOB	28.60	8.0	13	D DuFRESNE	5.834	8.0	13	MOLEMAN	18.00	8.0
14	B FORESI	35.32	7.0	14	B RUHE	28.22	7.0	14	C BOB	5.779	7.0	14	S MARQUARDT	17.00	7.0
15	M GIRVIN	35.14	6.0	15	J JORDAN	27.94	6.0	15	K ROBSON	5.745	6.0	15	M DICKSON	16.00	6.0
16	C BOB	34.97	5.0	16	D JOYCE	27.48	5.0	16	M DICKSON	5.733	5.0	16	B SEWARD	15.00	4.5
17	A McGUIRE	34.59	4.0	17	S BARRETT	26.51	4.0	17	D JOYCE	5.728	4.0	17	J EMERSON	15.00	4.5
18	M WEARY	34.50	3.0	18	J GORSKI	26.19	3.0	18	D KELLY	5.588	3.0	18	A RUHF	14.00	3.0
19	J EMERSON	34.47	2.0	19	D KELLY	26.17	2.0	19	B SEWARD	5.515	2.0	19	P GIBSON	13.00	1.5
20	REV JIM	34.17	1.0	20	M WEARY	26.15	1.0	20	C OZOLINS	5.500	1.0		M WEARY	13.00	1.5
21	E DARNELL	33.48		21	S MARQUARDT	26.13		21	J JORDAN	5.443		21	B MIALE-GIX	12.00	
22	MOLEMAN	33.31		22	B JACKSON	26.10		22	J ROMBLAD	5.397		22	D CHAVEZ	11.50	
23	W GIX	33.06		23	B SEWARD	25.49							J ROBERTSON	11.50	

## DOUBLING

BEST SCORE				MEDIAN SCORE				PLACING AVG				OVERALL			
PL	NAME	SCORE	PTS	PL	NAME	SCORE	PTS	PL	NAME	SCORE	PTS	PL	NAME	TOTAL PT	PTS
1	M GIRVIN	17	20.0	1	C SNOUFFER	11.0	19.5	1	C SNOUFFER	10.377	20.0	1	M GIRVIN	58.50	20.0
2	B SEWARD	15	18.5	2	M GIRVIN	11.0	19.5	2	M GIRVIN	9.417	19.0	2	C SNOUFFER	56.00	19.0
	G BROADBENT	15	18.5	3	B SEWARD	10.0	16.5	3	B SEWARD	8.130	18.0	3	B SEWARD	53.00	18.0
4	C SNOUFFER	12	16.5	4	M DICKSON	10.0	16.5	4	M WEARY	8.006	17.0	4	G BROADBENT	51.00	17.0
	BRUHE	12	16.5	5	M WEARY	10.0	16.5	5	G BROADBENT	7.900	16.0	5	M WEARY	44.00	16.0
6	M WEARY	11	10.5	6	G BROADBENT	10.0	16.5	6	M DICKSON	7.876	15.0	6	M DICKSON	41.50	15.0
	D DuFRESNE	11	10.5	7	G SNOUFFER	9.5	14.0	7	G SNOUFFER	7.638	14.0	7	G SNOUFFER	38.50	14.0
	W GIX	11	10.5	8	S MARGUERITE	9.0	11.0	8	D DuFRESNE	7.539	13.0	8	C BOB	27.50	13.0
	G SNOUFFER	11	10.5	9	C BOB	9.0	11.0	9	C LARRANCE	7.333	12.0	9	S KAVANAUGH	26.00	12.0
	C BOB	11	10.5	10	MOLEMAN	9.0	11.0	10	S KAVANAUGH	7.098	11.0	10	S MARGUERITE	23.50	10.5
	M DICKSON	11	10.5	11	E CARRIOG	9.0	11.0	11	MOLEMAN	6.938	10.0		D DuFRESNE	23.50	10.5
	S KAVANAUGH	11	10.5	12	J KOEHLER	9.0	11.0	12	S MARGUERITE	6.863	9.0	12	B RUHE	21.50	9.0
	J FLYNN	11	10.5	13	D DuFRESNE	8.5	7.5	13	J FLYNN	6.682	8.0	13	MOLEMAN	21.00	8.0
14	J YOUNGBLOOD	10	3.5		W GIX	8.5	7.5	14	A GRINDLE	6.445	7.0	14	J FLYNN	18.50	7.0
	R PARKINS	10	3.5	15	C LARRANCE	8.0	4.0	15	C BOB	6.303	6.0	15	W GIX	18.00	6.0
	B MIALE-GIX	10	3.5		B MIALE-GIX	8.0	4.0	16	B RUHE	5.902	4.5	16	C LARRANCE	16.00	5.0
	M GIESENSCHLAG	10	3.5		S KAVANAUGH	8.0	4.0	17	P DAVID	5.740	4.5	17	J KOEHLER	14.50	3.5
	E CARRIOG	10	3.5		E DARNELL	8.0	4.0	18	K GALEAZZI	5.663	3.0		E CARRIOG	14.50	3.5
	S MARGUERITE	10	3.5		REV JIM	8.0	4.0	19	L RUHF	5.333	2.0	19	B MIALE-GIX	7.50	2.0
	J KOEHLER	10	3.5	20	J JORDAN	7.5	0.5	20	D CHAVEZ	5.250	1.0	20	A GRINDLE	7.00	1.0
	MOLEMAN	10	3.5		D JOYCE	7.5	0.5	21	J KOEHLER	5.193		21	P DAVID	5.00	
								22	P RUHF	5.110		22	E DARNELL	4.50	

## ENDURANCE

BEST SCORE				MEDIAN SCORE				PLACING AVG				OVERALL			
PL	NAME	SCORE	PTS	PL	NAME	SCORE	PTS	PL	NAME	SCORE	PTS	PL	NAME	TOTAL PT	PTS
1	C SNOUFFER	70	20.0	1	C SNOUFFER	60.5	20.0	1	C SNOUFFER	10.710	20.0	1	C SNOUFFER	60.00	20.0
2	G BROADBENT	66	19.0	2	G SNOUFFER	55.0	19.0	2	J KOEHLER	9.655	19.0	2	G BROADBENT	52.00	19.0
3	G SNOUFFER	64	18.0	3	G BROADBENT	53.5	18.0	3	M GIRVIN	9.167	18.0	3	G SNOUFFER	50.00	18.0
4	C BOB	63	17.0	4	S MARGUERITE	53.0	17.0	4	D DuFRESNE	7.980	17.0	4	M DICKSON	40.00	17.0
5	M DICKSON	60	16.0	5	J GORSKI	44.0	16.0	5	S KAVANAUGH	7.619	16.0	5	S MARGUERITE	39.50	16.0
6	J GORSKI	55	13.5	6	E CARRIOG	42.0	15.0	6	G BROADBENT	7.613	15.0	6	J GORSKI	36.50	14.5
	W DAVIS	55	13.5	7	M DICKSON	40.0	14.0	7	M GIESENSCHLAG	7.500	14.0		S KAVANAUGH	36.50	14.5
	S KAVANAUGH	55	13.5	8	K FARR	39.5	13.0	8	G SNOUFFER	7.198	13.0	8	M GIRVIN	34.50	13.0
	M GIRVIN	55	13.5	9	B JACKSON	38.5	12.0	9	S MARGUERITE	6.912	12.0	9	D DuFRESNE	29.50	12.0
10	D DuFRESNE	54	10.5	10	A WINTERROWD	36.0	9.5	10	J JORDAN	6.875	11.0	10	C BOB	22.50	11.0
	S MARGUERITE	54	10.5		BRUHE	36.0	9.5	11	M DICKSON	6.504	10.0	11	M GIESENSCHLAG	22.00	10.0
12	B JACKSON	52	9.0		J ROMBLAD	36.0	9.5	12	K GALEAZZI	6.244	9.0	12	B JACKSON	21.00	9.0
13	M GIESENSCHLAG	50	8.0		S MARQUARDT	36.0	9.5	13	B SEWARD	6.297	8.0	13	J KOEHLER	19.20	8.0
14	J FLYNN	48	6.0	14	S KAVANAUGH	34.5	7.0	14	J GORSKI	6.236	7.0	14	B RUHE	17.50	7.0
	BRUHE	48	6.0	15	C BOB	34.0	5.5	15	C LARRANCE	6.000	6.0	15	E CARRIOG	15.20	6.0
	B PELL	48	6.0		N KERN	34.0	5.5	16	D CHAVEZ	5.500	4.5	16	W DAVIS	13.50	5.0
17	M WEARY	46	4.0	17	J EMERSON	33.0	4.0		M DEVITA	5.500	4.5	17	K FARR	13.00	4.0
18	B MIALE-GIX	45	3.0	18	M GIRVIN	32.5	3.0	18	P GIBSON	5.333	3.0	18	J JORDAN	11.00	3.0
19	S BARRETT	44	2.0	19	D DuFRESNE	32.0	2.0	19	B RUHE	5.253	2.0	19	J ROMBLAD	10.70	2.0
20	E CARRIOG	43	0.2	20	B SEWARD	31.0	1.0	20	C OZOLINS	5.000	1.0	20	A WINTERROWD	9.50	0.5
	J KOEHLER	43	0.2	21	M WEARY	29.0		21	J ROMBLAD	4.955			S MARQUARDT	9.50	0.5
	J ROMBLAD	43	0.2					22	C BOB	4.891		22	B SEWARD	9.20	
	REV JIM	43	0.2												
	B SEWARD	43	0.2												

## JUGGLING

BEST SCORE				MEDIAN SCORE				PLACING AVG				OVERALL			
PL	NAME	SCORE	PTS	PL	NAME	SCORE	PTS	PL	NAME	SCORE	PTS	PL	NAME	TOTAL PT	PTS
1	M WEARY	232	20.0	1	BRUHE	49.5	20.0	1	C SNOUFFER	10.205	20.0	1	C SNOUFFER	56.00	20.0
2	A GRINDLE	207	19.0	2	J FLYNN	43.0	19.0	2	M GIRVIN	10.200	19.0	2	M GIRVIN	51.00	18.5
3	C SNOUFFER	152	18.0	3	C SNOUFFER	37.5	18.0	3	G BROADBENT	8.948	18.0	3	J FLYNN	51.00	18.5
4	J FLYNN	113	17.0	4	M WEARY	26.0	17.0	4	D CHAVEZ	8.250	17.0	4	M WEARY	50.00	17.0
5	M GIRVIN	106	16.0	5	M GIRVIN	18.0	16.0	5	J KOEHLER	8.070	16.0	5	B RUHE	45.00	15.5
6	BRUHE	77	15.0	6	G BROADBENT	17.5	15.0	6	J FLYNN	7.847	15.0	6	G BROADBENT	45.00	15.5
7	P DAVID	64	14.0	7	J ROMBLAD	17.0	14.0	7	J JORDAN	7.515	14.0	7	A GRINDLE	27.00	13.0
8	A RUHF	59	13.0	8	MOLEMAN	13.0	13.0	8	M WEARY	7.469	13.0	8	S MARGUERITE	27.00	13.0
9	G BROADBENT	53	12.0	9	S MARGUERITE	9.0	12.0	9	S MARGUERITE	7.270	12.0	9	J KOEHLER	27.00	13.0
10	J KOEHLER	40	11.0	10	C LARRANCE	6.0	10.5	10	A RUHF	7.260	11.0	10	A RUHF	24.00	11.0
11	P RUHF	33	10.0		G SNOUFFER	6.0	10.5	11	B RUHE	6.785	10.0	11	S KAVANAUGH	23.00	10.0
12	S BARRETT	30	9.0	12	S KAVANAUGH	5.5	9.0	12	T W SMITH	6.667	9.0	12	T W SMITH	20.50	9.0
13	S KAVANAUGH	28	8.0	13	M DICKSON	5.0	6.5	13	A GRINDLE	6.000	8.0	13	MOLEMAN	17.00	7.5
14	L RUHF	26	6.5		C BOB	5.0	6.5	14	D DuFRESNE	5.861	7.0		D CHAVEZ	17.00	7.5
	W GIX	26	6.5		W GIX	5.0	6.5	15	S KAVANAUGH	5.809	6.0	15	C LARRANCE	15.50	6.0
16	T W SMITH	23	5.0		T W SMITH	5.0	6.5	16	C LARRANCE	5.667	5.0	16	J ROMBLAD	14.50	5.0
17	S MARGUERITE	22	3.0	17	S MARQUARDT	4.5	3.5	17	K GALEAZZI	5.576	4.0	17	P DAVID	14.00	3.5
	MOLEMAN	22	3.0		W DAVIS	4.5	3.5	18	M GIESENSCHLAG	5.250	3.0		J JORDAN	14.00	3.5
	K KENNY	22	3.0	19	E CARRIOG	4.0	1.0	19	J ROBERTSON	5.000	2.0	19	W GIX	13.00	2.0
20	J ROMBLAD	20	0.5		D DuFRESNE	4.0	1.0	20	MOLEMAN	4.997	1.0	20	G SNOUFFER	10.50	1.0
	M DICKSON	20	0.5		B PELL	4.0	1.0	21	W GIX	4.932		21	P RUHF	10.00	
								22	G SNOUFFER	4.914		22	S BARRETT	9.00	



## BITS & PIECES

### News From The USA

**Mark Weary** is the latest newcomer to the *Super Catch Hall of Fame*. Using his Romblad Composite MTA and Weary "Ice Runner" tri-blader, Mark was able to complete 7 F/C catches under his MTA, despite two drops. If Mark had completed a perfect round, this would have been a new World Record with 9 catches.

Three World Records were set at the first Arizona tournament, held in Phoenix, on October 16. First, **Michael Girvin** started the sequence by setting a World Record in Doubling (new USBA rules) with 17 catches. Then, **Will Gix**, with a score of 91, broke the long standing World Record score of 90 points in Australian Round, previously set by **Brother Brian Thomas** nearly 10 years ago. Will's World Record was short lived though. Only a few minutes later, tournament host **Mark Weary** scored an incredible 92 points to take first place in the event and the current World Record mark. Both Will and Mark were using the Aussie Round boomerang: *Phenolic Sunshine* made by **Michael Girvin**. You can get your own *Phenolic Sunshine* by writing to **Michael Girvin** at the address that follows. Ask for a catalog of his other fine competition products.

**Michael "Gel" Girvin**  
2124 Kittredge St. #61  
Berkeley, CA 94704



### Bud Pell, Juggling In Jackson

**Gregg Snouffer** mailed in a copy of the August 3, 1993 edition of the *Seattle Post-Intelligence* with terrific coverage of the 1993 USBA Nationals. The article had action photos of both **Chet Snouffer** and **Steve Kavanaugh**. Gregg also mailed in a copy of the 4 August 1993 edition of *USA Today* which featured an excellent article about boomerangs with a photo of reigning World Champion: **John Koehler**. The newspaper also offered a candid admission that boomerangs did not necessarily originate in Australia. The essay, with a nationwide distribution, included a plug for the USBA.

**Bud Pell** has been busy trying to obtain a commitment by the city of Jackson, Michigan to host the 1994 USBA Nationals. The front page of the 20 October edition of "The Jackson Citizen Patriot"

newspaper carried an article on the negotiations which included the caricature (pictured left) of Bud juggling two boomerangs.

The November 1993 issue of "Games" magazines featured a *high/low quiz* which provided the reader with statements about different trivial events. One of the statements was about the MTA boomerang. The quiz said "a boomerang has flown 86 seconds before being caught by the thrower". The answer section in the back of the magazine correctly mentioned that the statement was low. It listed **Dennis Joyce's** competition throw and catch of nearly 3 minutes in 1988 as the current record in that event.

The 28 October issue of the *Santa Paula/Filmore Star-Free Press* carried an article, written by **Michael Goldowitz**, about local artist and boomerang manufacturer: **Alan Scott Craig**. Most of the readers already are aware of Alan's work through the movie: *The Baghdad Cafe*. Alan was the boomerang throwing drifter who played a major role in the popular German film. Alan is still making boomerangs after all these years. In fact, he makes his living producing some of the most spectacular art boomerangs ever created. His boomerangs usually integrate animal art. Often, he makes sets that depict animals in motion. Some of these sets have 20 or more boomerangs and sell for \$10,000. These are selling prices, not asking prices and Alan is continuously back-ordered! Every boomerang he makes is a terrific flyer as well. Single boomerangs start at about \$65. This is affordable enough for the majority of the readers. Collectors can inquire about Alan's fine art products by writing to the following address:

**Alan Scott Craig**  
358 Bard  
Fillmore, CA 93015



### THE BOOMERANG MAN

"Giving fast, personal service since 1975!"

RICH HARRISON'S FREE CATALOG #18-A

Offering You a Broad Selection: Wood; Plastic;  
Graphite; Paxolin; Perinex; Foam; Paper & GFK Booms

1806 No. 3rd St., RM → Monroe, LA 71201; (318) 325-8157



**BC by Johnny Hart**



David Hetrick was browsing through some old *National Geographic* magazines when he stumbled on a great picture of a dozen Australian Aborigines standing around a mound with all their weapons in a pile. The Aborigines were from Sunday Island and the magazine was dated January 1927. Look for this one in an old book store in your neighborhood.

*Children's Television Network* is the producer of the famous *Sesame Street* television show for children. They also produce publications for children of various age groups. The "3-2-1 Contact" magazine is geared for children aged 8 to 12. In the September issue, one of the articles covered items from the 1992 NASA Spin-off publication that would be of interest to children. Color illustrations included a boomerang flight path taken at night with lights, as well as a Paxolin MTA by **Günter Möller**. The article encouraged young children to look for boomerangs in toy stores.

The *NASA Regional Technology Transfer Center*, based in Los Angeles, has procured a strip laminated Midi-MTA made by **Ted Bailey** (S/L blank made by **John Cryderman**) to display at the Technology 2003 Trade Show in Anaheim on 7-9 December. **Steve Conaway** and **Alan Scott Craig** plan on participating in the show by demonstrating indoor booms and answering questions to inter-

ested passer-bys. This is a great way to get technical people interested in the science of boomerangs.

Many thanx to **Rich Surace** of *Flite Stix* who sent in the BC cartoon (see above) by Johnny Hart. Keep sending in these goodies for the readers to appreciate.

**Gregg Snouffer, Charlie Kunkel** and **Scott Ayers** gave a boomerang demonstration at *Australia Night* which was held in Dayton, Ohio on 13 November. The event, which focused on Australian cultural activities, was small, but there are plans to make the gathering an annual event.

**Ted Bailey** gave a presentation on the history and science of the boomerang to the *University of Michigan* student chapter of the *American Society of Mechanical Engineers* (ASME) on 16 November, assisted by PhD candidate and fellow boomerang thrower: **Jim Sprague**. Handouts were passed out with information on the USBA and local throwing activities.

The December 1993 issue of the ASME publication "Mechanical Engineering" carried a 3 page article on boomerang technology. You can order your own copy using M/C or VISA. Call 212-705-7722 for information.

*SYMIX* is a supplier of fully integrated manufacturing and management software systems that promises to provide a return on your investment in 12 months or

less. In the 6 September issue of *Industry Week*, a full page advertisement appeared featuring a boomerang that suggested a *Rapid Return* message for their service.

A new retail business has formed in Timonium Crossing, Maryland called "Boomerang Words & Gifts". This business markets just about everything from olives to kites and wind-socks. With a name that includes the word "boomerang", maybe it would be possible for one of the readers to interest the owner in adding boomerang products to their stock. No phone number was available, but the owner's name is **Stacey Fortson**.

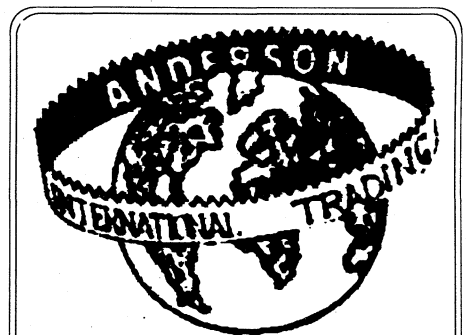

For the very best quality Finnish Birch Plywood with a 5% USBA discount:

**Anderson Int'l Trading**  
**1011 West Barkley Ave.**  
**Orange, Ca. 92668**

(800)-454-6270  
 (714)-771-6270

"El Pollo Loco" is a new brand of cereal that is being distributed in the American South West (CA, NV, TX), targeting kids of Mexican decent. The box has a small plastic boomerang as a promotional gift (Don't tell Eric!).

Sanyo has come out with a new microwave oven with a dish circulating system that returns the dish to the front of the oven at the end of the cooking cycle. The cycling is done by a device called the "boomerang turntable".

A new technology for vehicle to vehicle communication has been proposed by three Japanese researchers using "spread spectrum technology". The system will be marketed under the trade name: "Boomerang Transmission System".

**Burt Rutan**, the builder of many new and innovative aircraft, has done it again. This time the flying machine is called "The Boomerang; Model #202-11". The aircraft (pictured right) is for his personal use only and it has twin booms and a gross weight of only a ton.

*Energy Alert* magazine recently mentioned that the South American country of Bolivia is about to increase its oil production by pumping oil out of the "Boomerang Hills" region of that country. Do any of the readers know why this geographic region has such a name?

**Steve Conaway** sent in a copy of an article from the 12 July issue of *Autoweek* magazine that describes a new vehicle made by *Masserati* called "Boomerang". Obviously, few of the readers can afford to buy one.

Design patent (#D0340480) was recently awarded to **Rodney Cummings** on 19 October for an ornamental indoor boomerang. No diagram of the new toy was available in the report. Can any of the readers shed more light on this new product?

The Australian Catalogue Company has issued their new 93-94 catalog full of things made in Australia. Of special interest to boomerang throwers are boomerang pins and earrings, Aboriginal music tapes, and miscellaneous wooden artifacts like the didjeradu and bull-roarer. You can obtain a catalog by calling Pam Wood at (919)-878-8266 or by writing to:

**The Australian Catalogue Co**  
7412 Wingfoot Dr.  
Raleigh, NC 27615

Gemz has come out with a new catalog of boomerang products. Several new items include a closed form plastic tri-blader, MTA, and a reverse hook called "Bun-Yip". This extra large layout catalog can be obtained by calling **Tony Gembeck** at (503)-230-8955 or by writing to:

**GEMZ**  
P. O. Box 5241  
Portland, OR 97208

**Gregg Snouffer and Rick Tilford** of *Roundtrip Boomerangs* have been successfully marketing a small indoor tri-blader called the "Tantrum" (middle right). This boomerang is made out of crimped poly-styrene and it is one of the easiest boomerangs to demonstrate in closed quarters. Gregg writes to notify MHR readers that there is now a new improved and larger version of the Tantrum (bottom right) for outdoor throwing. This tri-blader is also very easy to throw. It has a

hole in the center for catching it on your finger. Another new outdoor boomerang is a lightweight two blader (left), called the "Ticket Junior" which is made out of *Celtex* material. All three of these boomerangs are lightweight and recommended for retail sales or for introducing new throwers to the sport. The mini-Tantrum retails for about \$2. The outdoor Tantrum and Celtex Ticket Junior retail at about \$5 each. Wholesale prices (50%) are also available to interested parties. You can purchase both small and large quantities directly from *Roundtrip Boomerangs* by calling Gregg at (614)-363-4414 or by writing to:

**Gregg Snouffer**  
340 Troy Rd.  
Delaware, OH 43015

### News From Australia

The annual Albury comps were held on October 2. Participants were treated to the companionship of 89 year old **Arthur Janetzki** who went all out in: Accuracy, Australian Round, and Fast Catch. **Jeff Lewry** rode his horse 30 km just to meet with the competitors. The second day of competition was plagued by the heaviest rains in history that washed out the roads leading out of town. **Bruce Carter** won the day with **Rob Croll** and Aborigine **Andrew Travis** following close behind.

The 1994 BAA National Comps will be held in Sydney on March 19/20. If any of the readers are in the area, please be sure to drop in for a throw.

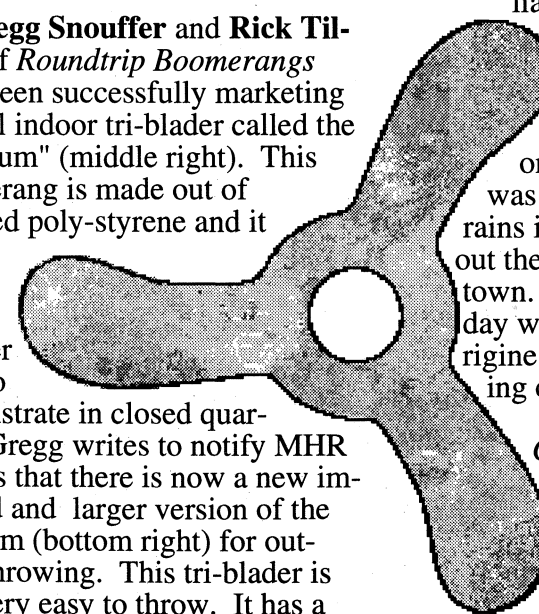
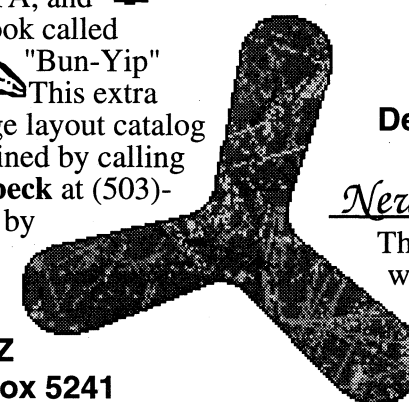
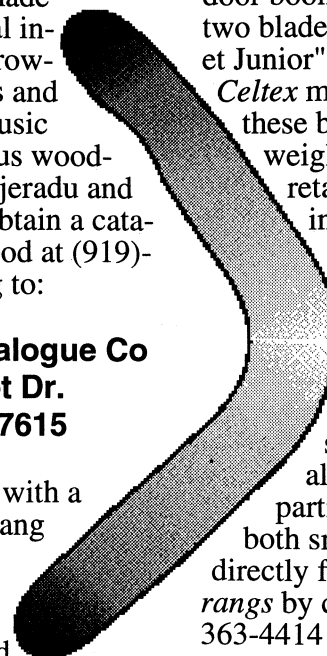
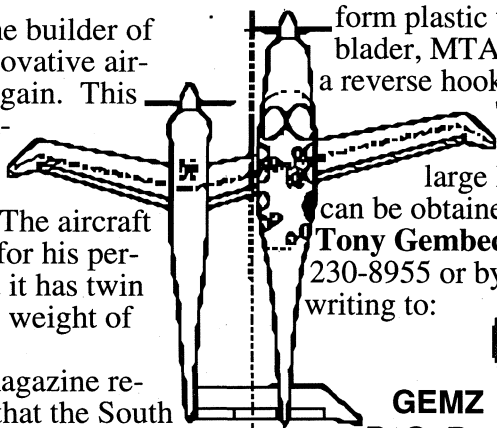



**EMU (Beak) Boomerang**

**Dave Hetrick** has identified a new domestic source for Australian Aboriginal throw sticks. These artifacts are available at really attractive prices. **Paul Tiger** of *Tara Imports* has begun importing quality hunting sticks in both plain and highly decorative finishes for both the thrower and collector. These are the same Australian Aboriginal artifacts that are on display in Australian embassies around the world. Plain throw sticks cost only \$30. Decorated throwsticks cost between \$100 and \$200 depending on the size and mounting. Emu (beak) and Snake throw sticks are available at only \$25 apiece.



**Snake Boomerang**

There is a \$10 shipping charge for each throw stick to USA addresses. Interested parties from other countries should write for more details. These items are well worth the price. Call Paul at (707)-643-5914 or write to the following address for more information:

**Tara Imports**  
**636 Valle Vista Ave.**  
**Vallejo, CA 94590**



**Plain Hunting Boomerang**

**Brother Brian M. Thomas** and the *Boomerang Throwing Association of NSW* has put together a marvelous videotape, compiling most of Brian's personal Super 8 movies into a video sequence of more than 2 hours in length. The tape is filled with informative commentary by Brian and his boomerang throwing pal: **Tony Butz**. Professionally animated captions, with background music, were added to the tape by **Ross Linton**. All in all, this is a very well put together production. The video has clips depicting 2 year old **Baby Ben Loveland's** historic winning throw at the BAA Championships, in which he beat other competitors aged up to 16 years. See the **Janetzki** brothers in full throwing form. There is extensive coverage of the first Australia/USA Challenge Match in 1981. See a young **Chet Snouffer, Al Gerhards, Barnaby Ruhe**, and other American throwers compete against Aussie greats in the three match series. See **Rob Croll** with a full head of hair. See all the great Aussie throwers in competitive action: **Bluey Roberts, Bunny Read, Morris & Dennis Maxwell, Jack Byham, Jeff Lewry, Billy Knight, Tony Butz, Rod Jones, Lorin Hawes**, and of course **Brother Brian Thomas** himself. The tape also includes 10 minutes of television clips featuring Brian in *Wonder World* and **Jeff Lewry** on *Getaway*. The cost for this marvelous video collection is only \$45 (Australian). This cost includes both air-mail postage and translation into NTIC (video format that is used in the USA). You can send a bank draft made out to an Australian bank or an international money order directly to Brian at the following address:

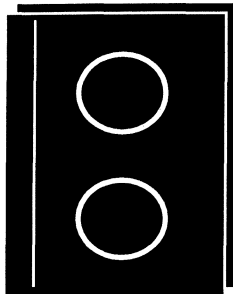

**Brother Brian M. Thomas**  
**Waverly College**  
**131 Birrell St.**  
**Waverly, NSW 2024**  
**Australia**

Readers from the USA and Canada can send a check or M.O. for \$40 (USD) directly to Ted Bailey at the address below before February 15, 1994. A group order will be sent to Brian at that time. A group order will help to defray the cost of obtaining a bank draft in Australian funds by several individual customers.

**Ted Bailey**  
**P. O. Box 6076**  
**Ann Arbor, MI 48106**

**Ed Russell**, who wrote an excellent article on "The Whistler Boomerang" in MHR #55, has identified a newly published book on boomerangs; written by **Monte Huebsch**. Monte immigrated to Australia from the USA as a Space Scientist in 1988. He currently resides in Brisbane with his wife and child. The book, depicted below, is profusely illustrated by **Randy**

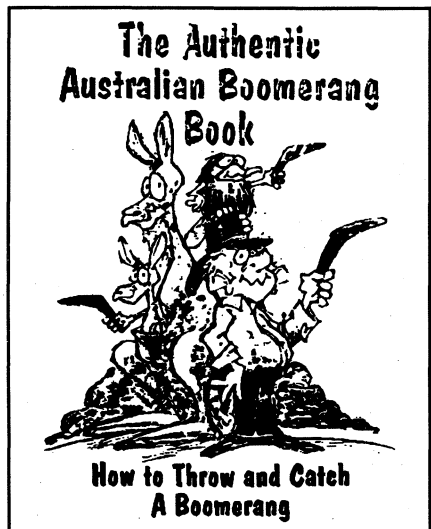

**Rumpf**. The book is offered with and without a boomerang crafted by Aborigine **Dennis Bobongie**. Interested parties can call Dennis at 07-285-5331 or write to:

**Dennis Bobongie Artefacts**  
**P. O. Box 361**  
**Kallangur 4503**  
**Brisbane**  
**Australia**

**John Gibney** is a fan of the cartoon series "Beetlejuice". Recently, John watched an episode titled: "Oh Brother!" which contained a lot of reference to Australia, including a scene with boomerangs.

*News From Bulgaria*  
**Georgi Dimantchev** is an extremely prolific designer of new boomerang models. He has recently come up with a new model called "Focus", depicted left, that has incredible resistance to wind. The boomerang spans only 22 cm. and weighs 26 gm. It is made out of a thin & dense glass-fibre and metal composite material. For more information on this new product, contact Georgi at:

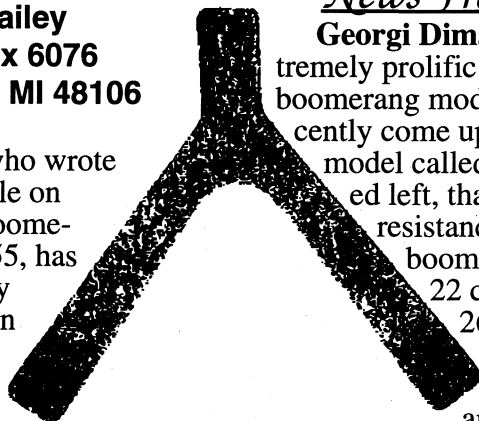

**Georgi Dimantchev**  
**Bulgarian Boomerang Club**  
**Hipodruma 139A-A-23**  
**1612 Sofia**  
**Bulgaria**

*News From France*  
**Michel DuFayard** writes to let the readers know the results of the *Second French Long Distance Cup*. that was held in Sedan on 25/26 September. On the first of three rounds of four throws, **Udo Wenning** set a new German Record with a throw of 122.20 metres. This broke the previous German record of 117.20 metres.

On day 2, **Renaud Breton** of France made a throw of 143.10 metres. He also made a throw of 118 metres, with a catch. **Eugène Cinal** made a throw of 122 metres on his first ever long distance competition. There were 18 French, 6 German and 1 English throwers. Nine throwers broke the 100 metre mark. The event received outstanding coverage by the local Sedan newspaper. Congratulations to all!

**Uwe Niederstraßer** wrote to inform the readers about the *Double World Record* that was set in Abondance on 21 August. Both **Uwe Niederstraßer** (Germany) and **Jurg Schedler** (Switzerland) tied the existing Accuracy world record of 49 points that was originally set by **Phillippe Picgirard** (France) in Evry in 1990. Can a perfect score of 50 be far away?

**Olivier Vouktchevitch** announces that he will step down as editor of the popular *France Boomerang Association* newsletter. It is with sadness that we announce his departure from this position. Olivier's regular mailing was informative, impartial, and a wonderful source of information for the *Bits & Pieces* column. **Fabrice Pucetti** will replace Olivier as editor of the FBA newsletter.

**Didier Bonin** is well known throughout the boomerang world as a gifted craftsman of those animal/cartoon shape boomerangs, like the Toucan, Road Runner, and Coyote. Didier has recently become involved in the construction of beautiful inlay and marquetry boomerangs, using beautiful tropical hardwoods such as rosewood and ebony. Because Didier is also a collector, he would be willing to swap some of these works of art for other attractive collectable boomerangs to supplement his collection. Photograph of some of his boomerangs are depicted on this page. For more information on trading with Didier, contact him directly at the address that follows:



**Didier Bonin**  
**Boomerang Club Dijon**  
 15, rue Vannerie  
 21000 Dijon  
 France

### News From Germany

**Uli Konzelmann** writes to mention that he is pleased that the 1000 second barrier has been broken with the incredible throw and catch by **John Gorski** last August. Uli mentions that there is an older gentleman in Germany that likes to throw his MTA from the top of a hill. Flights have perhaps exceeded 17 minutes, but there is no catch and there is an additional vertical drop before the boomerang hits the ground.

**Hartmut Steeb** built a small Balsawood boomerang and passed it on to an Astronaut friend who took the boomerang for a ride on the Space Shuttle "Discovery". Several throws were made, but there is no report of how the boomerang flew compared to its flight back on Earth.





## News From Russia

**Vladimir Alekseev** writes to inform MHR readers on the history of the recently organized Russian club. The *Russian Boomerang Association* was formed in July 1992 after a newspaper article was published in Moscow about the proposed 1993 World Cup, which was scheduled to be held in Canada. Vladimir, who currently serves as club President, has made contact with clubs from the USA and Europe. Because the club is both new and small, the primary focus is on increasing the membership and promoting boomerang throwing throughout the states of the former USSR. There is a strong focus on bringing children/teenagers into the sport.

The members are involved in experimentation with new shapes (such as those depicted on page 25 of MHR #55). The most enthusiastic designer in the club is Vice-President **Arkany Nemoy**. The beautiful art work on some of the boomerangs is a result of the club promoting an interest in local artist groups, such as *The Artist's Union of the Russian Federation* and *The International Federation of Artists* from UNESCO. The boomerangs are made as part of an exhibition that includes both the artist's boomerang and canvas paintings.

The new club is enthusiastic about developing the competitive aspects of the sport. Assistance is solicited from the various world clubs to help the Russian club develop rules as well

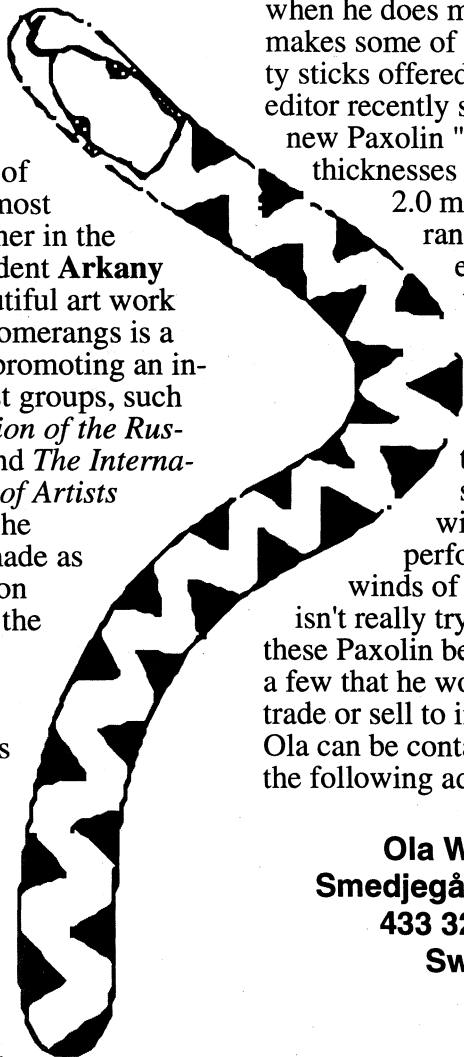

as anything else associated with competition throwing. The Russians are hopeful that they will host an invitational competition in the future after they are more seasoned throwers. If you can help them with their development efforts, please write directly to Vladimir at the following address:

**Vladimir Alekseev**  
**Russian Boomerang Assoc.**  
**129343 Moscow**  
**Nansen St. 2/2, 22**  
**Russia**

## News From Sweden

**Ola Wahlberg** has had limited time to make boomerangs because of his obligations to family and his job as a physician. However, when he does make 'rangs, he makes some of the very best quality sticks offered in Europe. The editor recently sampled two of his new Paxolin "Snake" MTAs in thicknesses of 1.75 mm and 2.0 mm. These boomerangs were relatively easy to throw and were decorated with wonderful art (depicted left) in bright day-glo colors. Although the MTA is designed for light winds, the samples perform quite well in winds of 10-15 mph. Ola isn't really trying to market these Paxolin beauties, but he has a few that he would be willing to trade or sell to inquiring readers. Ola can be contacted by writing to the following address:

**Ola Wahlberg**  
**Smedjegårdsvägen 3B**  
**433 32 Partille**  
**Sweden**

## SUPER CATCH HONOR ROLL

**Ted Bailey (6)**  
**Volker Behrens**  
**Gerhard Bertling**  
**Didier Bonin**  
**Rob Croll (7)**  
**Eric Darnell**  
**Doug DuFresne**  
**John Flynn**  
**Torsten Fredrich**  
**Fridolin Frost (8)**  
**Mike Forrester**  
**Kim Galeazzi**  
**Matthias Giesenschlag**  
**Michael Girvin**  
**Rob Greer**  
**Thomas Hartmann**  
**Axel Heckner**  
**Dennis Joyce**  
**John Koehler**  
**Uli Konzelmann (8)**  
**Jason Krouse**  
**Charlie Kunkel**  
**Jeff LaCount**  
**Mike LaPrade**  
**Ray Laurent**  
**Gerrit Lemkau**  
**Alain Mangin**  
**Mole Man (6)**  
**Gunter Moller**  
**Rob Parkins (8)**  
**Roger Perry (6)**  
**Philippe Picgirard**  
**Jonas Romblad**  
**Barnaby Ruhe**  
**Larry Ruhf**  
**Tim Schallberger (8)**  
**Chet Snouffer (7)**  
**Gregg Snouffer (7)**  
**Olivier Vouktchevitch**  
**Ola Wahlberg (6)**  
**Mark Weary (7)**  
**Matthieu Weber (8)**

(#): No. of fast catches if more than 5  
*For those who are unfamiliar with the term: Super Catch; the thrower must launch a MTA from the center circle, then complete a round of Fast Catch from the same circle. The thrower must then catch his MTA. The thrower has the option to throw & catch more than 5 times within the F/C sequence.*

## New Boomerang Publication

by Ted Bailey

Over the past seven years, I have had the great pleasure of editing both "Many Happy Returns" and the independent "Boomerang Journal". Both of these ventures served as an excellent vehicle for me to sharpen my writing and desktop publishing skills.

Because of reasons too complicated to discuss in this column, I have decided to leave the MHR production staff and initiate yet another independent boomerang publication. I will retain a consulting position with MHR and plan on writing an occasional article for MHR. I have recently spent several thousand dollars on new computer equipment and software to improve the quality of page layout and photographic halftones. This equipment will also be used to assist in the production of MHR.

This new venture will contain material much like what you have read in the "Bits and Pieces" column of the past several issues. An eight page newsletter will be distributed six times a year. There will be no paid advertisements, but information will be provided

on new products of interest to all. There will be no political statements or long-winded tournament write-ups. Instead, each issue will include information on new records, tidbits on boomerang trivia, and an accurate calendar of events to keep the reader abreast of updated tournament info.

This production offers no allegiance to any organization. Instead, it is intended to strengthen the bond between international organizations through more effective communications. As with MHR and "Boomerang Journal", I will continue my correspondence and newsletter exchange program with clubs from around the world.

As time allows, I will produce and market additional documents that focus on single historical or technical subjects in much the same way as technical papers are made available through various professional societies.

Up-to-date information services (hard copy and DOS/Macintosh databases) will also be made available, but only to paid subscribers.

There are many good reasons for subscribing to this publication. My reputation for producing a punctual and informative publication is well known and appreciated by the international boomerang community. If you enjoyed

"Boomerang Journal" and the "Bits and Pieces" column in MHR, then this newsletter is for you.

Subscriptions are being accepted immediately. The subscription rate is only \$8 in the USA/Canada and \$15 overseas. Interested overseas parties can send payment by Traveler's Check, bank draft, or International Money Order (in US funds). Please make out all payments to: "Ted Bailey" and mail to:

**Ted E. Bailey**  
**P. O. Box 6076**  
**Ann Arbor, MI 48106**

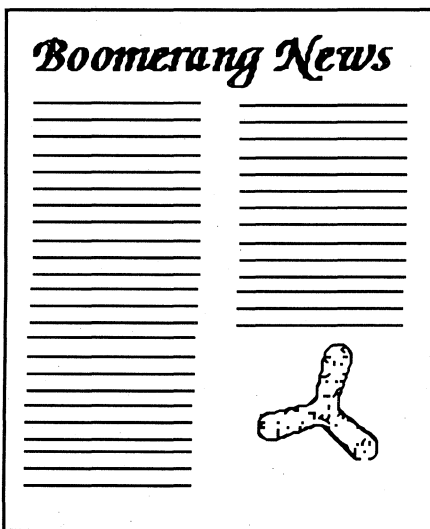

# COMPETITION RECORD SUMMARY

Compiled by Didier Bonin - October 1993

Event	Australia	USA	Europe
Australian Round Accuracy	90 (Br. Brian Thomas) 48 (Dennis Maxwell)	92 (Mark Weary) 48 (Dennis Joyce)	86 (Axel Heckner; Germany) 49 (Uwe Niederstraßer; Germany) 49 (Philippe Picgirard; France) 49 (Jurg Scedler; Switzerland)
Consecutive Catch	765 (Rob Croll)	620 (Dennis Joyce)	801 (Stephane Marguerite; France)
Distance (metres)	113 (Bob Burwell)	134.20 (Jim Youngblood)	149.12 (Michel DuFayard; France)
Endurance	58 (Rob Croll)	75 (Rob Parkins)	73 (Mathieu Weber; Switzerland)
Fast Catch	20.35 (Rob Croll)	16.74 (Rob Parkins)	15.03 (Gregory Bisiaux; France)
Juggling	69 (Bob Burwell)	502 (Chet Snouffer)	353 (Fridolin Frostl Germany)
MTA <sub>100</sub>	64.50 (John Gibney)	71.15 (Paul David)	84.67 (Fridolin Frost; Germany)
MTA <sub>unl</sub>	153.18 (Rob Croll)	179.94 (Dennis Joyce)	Philippe Picgirard; France)



---

## The 14<sup>th</sup> Annual Free Thrower's Fling

---

The 14<sup>th</sup> Annual Free Thrower's Fling in Delaware, Ohio came off splendidly on August 7 and 8. Thirty-four veteran throwers and 4 novice tossed in the sunshine. The presence of international stars like Sweden's Jonas "Thermal-Out" Romblad, USBA co-founder and living legend Rusty Harding, and World Champion Team Coach Barnaby Ruhe made it an especially magical weekend. Flynny and Barnaby road-tripped it in and out for the Saturday tourney, while Rusty Harding came up from Tennessee and amazed all with his presents and presence. His booms still possess that Harding mystique and they fly like dream sequences.

Columbus TV Channel 4 sent up Steve Saunders to do a Steve's Sportsworld Segment. His segments feature terrific special effects, with strobe action, stop-action, and killer soundtracks to boot. He captured Gary Broadbent's soliloquy of madness wherein he describes boomerang throwing as the number one sport in the world... "bobbing, weaving, shaking, baking, stopping on a dime, leaving nine cents behind, low to the ground, hard to bring down, bodacious, vivacious"...heck no one can get it all!! Cool action sequences of Chet and Gary hot dogging and going, "Yeow" make ya wanna go out and throw some right now! Of course, the main highlight was John Gorski's INCREDIBLE 17 minute flight on Sunday that hovered out and back and descended on the field for the catch. It was phenomenal. Jonas was there to see the feat with one of his MTA creations. We were absolutely freaking out and everyone immediately packed their booms and left the field with nary another

boom tossed after the religious experience. It just didn't seem right to toss any more that day.

In tourney action, I played poor host by winning the overall title, but outside of a 19 in trick catch and a 19 in Fast Catch (both brought about by Chicago Bob who's superb throwing pushed me to it), I left the best throwing of the day to others. Stephane Marguerite came in from Montreal to rip a 74 in some very tricky light and variable Aussie Round winds. Delaware's Jason Krouse came up to me after three throws in MTA and said, "Chet, ya gotta help me. I need a score bad." Wanting to be a nice guy, and feeling pretty secure with a 36 on the board, I loaned him a Jonas that I could never get to fly right! "Here, try this." (Hey, what are friends for?) He pops it up for a 45 second flight that just hung there! Served me right. Ben Owen post-throw controlled his Accuracy Boom in for a 38.

Afterwards, we retired to the Tall Pines Restaurant and wolfed on some chow and passed out awards and listened to Rusty tell stories of the days before tri-bladers and easy scores!

On Sunday, we had a Free Throw which approximated a Beach Blanket movie. With tunes cranking from the van, Alan Winterrowd and anyone who wanted to tossed some disc, and we played games. If we didn't think the right team won the game, we played again. It was a fun, relaxing day where everyone could simply do what they wanted. Ben Owen's team was humbly named "Hot butter on toast" and consisted of every babe on the field including Carmen, Steph, Tara, plus some short, wild-haired stud whom we all hated at the time, but let his team take rethrows for the slightest interference, because, as Alan put it, "They just looked so good trying." Hope to see you there next year!

## Nationals and US Open in the Great Pacific Northwest

Thirty-seven throwers ascended to the Pacific Northwest and Seattle for the 1993 US Open and National Championships. The setting was an incredible Soccer complex near Redmond, with 16 fields side by side. With hot air balloons hovering nearly every evening and radio controlled gliders soaring in the adjacent field, it was flight heaven. The winds were gracious and allowed some superb scoring throughout the weekend, with just enough slice and dice thrown in to make it interesting.

Chet Snouffer got in the zen groove early and never left, taking five-firsts (Trick Catch and Doubling, 12; Accuracy, 42; Aussie Round, 78; Endurance 48) and a second (MTA 36.59) and never lower than 6th to rack up 80 points and the Open title for the second year running. Steve Kavanaugh carried out the Barnaby Ruhe consistency strategy beautifully, with 2nd in Aussie (72 points), 3rd in Doubling (10), and 4th in Juggling (6) to go along with a handfull of 5th-7th finishes for second overall at the Open. Third went to Moleman with 2nd in Count-up (11) and Juggling (9), fourth Overall to Mike Dickson of Canton, OH, and 5th to John Koehler with 2nds in Fast Catch (19.6) and Juggling (9). Rounding out the top twelve who advanced to the National Championship on Monday were: 6th: Gary Broadbent, 7th: Doug DuFresne, 8th: Gregg Snouffer, 9th: Casey Larrance, 10th: Mark Weary, 11th: Byron Seward, and 12th: John Gorski.

Other first place event winners at the Open were Casey Larrance in Juggling with 17, Betsy Miale-Gix in Fast Catch with a ripping 19.14 seconds, and Barnaby Ruhe with 39.37 seconds in MTA. At the Nationals, the scoring was much tighter, with Chet and Mark

Weary two-stepping around the lead early, then Mark grabbing it and looking to say, "Adios", before Chet rallied and took it back for keeps...but not by much! Four throwers tied for first in Trick Catch with 11. Stevie K., John Koehler, Mark and Chet just edged Mike Dickson, Doug DuFresne, Gregg Snouffer, Byron Seward and John Gorski at 10, but with all the ties, the point spread was 4.75 in favor of the 4 after one event.

Chet went into a total zone and scored 4 bulls and an 8 to tie the US Record in Accuracy with 48, while Gary Broadbent (39), John Gorski (38) and Gregg Snouffer (37, tie with Mark Weary) made it a Buckeye State sweep in the event.

Fast Catch went to Weary who smoothly stroked five around in 20.89 seconds. Gorski took second with 21.59 and Gregg was 3rd with 22 flat.

In Australian Round, Moleman drilled a 79 to edge Moleman with 78. Mike Dickson and Chet sat on 68, while Koehler scored 66.

Great throwing all around with several 20 point bullseyes tossed in the variable winds.

In MTA, Moleman popped a 34.75 second flight. Casey tossed

booms out of the park in warm-up as if he had some inside connection with Jonas, but then failed to score...we think he ran out of sticks! Mark Weary surged to score a 33.45 for second place and nearly ring the death knell on Chet's title hopes until "the Jet" averted disaster on his final throw for a 31.33 for 3rd.

In Doubling, Koehler and Snouffer made it to 12 and then got to 13 and 15 respectively ahead of Broadbent, Casey and DuFresne all at 11.

In Juggling, the wind was up and people were drifting downwind at a rapid pace. Mike Dickson scrambled for an impressive 19 catches to finish 3rd. Gregg Snouffer gut-

ted out 27 for 2nd, and Gary Broadbent stood and delivered in a slight and short-lived window for 35 catches and first place.

By Endurance, Gregg was now awake and won it with 54 catches in a wind that was steady but pushing pretty hard. The strong finish vaulted him to 3rd place overall. Chet racked up 53 to clinch second place and his 8th National Championship; the seventh in a row. DuFresne was 3rd with 51, moving him up to 4th overall. While Mark Weary had trouble in the tricky winds and snagged 42 for 8th place, he'd already done his homework and had built a substantial lead so that he secured second place overall.

#### 1993 US Open

1. Chet Snouffer 80.12
2. Steve Kavanaugh 46.36
3. Moleman 43.69
4. Mike Dickson 43.97
5. John Koehler 43.28
6. Gary Broadbent 42.85
7. Doug DuFresne 42.67
8. Gregg Snouffer 38.19
9. Casey Larrance 34.1
10. Mark Weary 32.35
11. Byron Seward 30.74
12. John Gorski 29.96

#### 1993 National Championships

1. Chet Snouffer 63.25
2. Mark Weary 51.25
3. Gregg Snouffer 48
4. Doug DuFresne 42
5. Gary Broadbent 38
6. Casey Larrance 36
7. Steve Kavanaugh 33.58
8. Moleman 33.5
9. Mike Dickson 31.5
10. John Koehler 31.25
11. John Gorski 28.33
12. Byron Seward 11.33



---

# World Records Fall in Phoenix

---

by Gregg Snouffer

It was an exceptional southern Arizona weekend of October 15/16 when Mark Weary's first-ever Phoenix tournament was held. It was a weekend of rainfall in the desert, with cloudy skies in marked contrast to the sunny 85 degree heat that characterized the rest of the week. But it was more than just rain that fell on a small field attended by only 13 veteran throwers, yet observed by nearly as many local Mexican youths. It was a weekend for world records to fall.

The weather, which at first appearance seemed dismal, turned out to be the great aiding factor, as the cool overcast provided for steady 3-5 mph winds, in contrast to the fickle warm winds which are the norm. It was the last chance of the season to increase ratings for those who were thinking of Japan '94, and the throwers who made the journey were richly rewarded as the conditions yielded several best scores of the season for the ratings.

The order of events also contributed to setting two of the three world records for the day.

Leading off with trick catch and doubling, it was Michael Gel Girvin who asserted his dominance in this aspect of the sport by racking up 14 in Trick Catch and a world record 17 in Doubling (under the new rules established in 1992). He was challenged only by Chicago Bob in Trick Catch with 13, while Gregg Snouffer and Mark Weary dropped a foot catch and ended up with 11. In doubling, it was Steve Kavanaugh who joined Chi-Town and Gregg with 11 catches in second.

When Endurance came up, so did the winds, as the third event was won by Gregg, with 57, closely followed by Steve at 55 and Gel at 53. Kim Galeazzi finished fourth with 42. Fast Catch followed in the trickiest winds of the day, as just 6/100 of a second

divided the top three finishers. It was Chicago Bob on top with 26.28, with 26.31 for the Wearymeister and 26.34 for Gel in third.

The winds were still up, but fairly constant when Gregg won Accuracy with 42, throwing an old Chet Aussie Secret that flopped out of the air for 2 bullseyes. Kim Galeazzi was second with 38 and Weary followed at 36.

By the time MTA was finished, so were the winds. But it was phenolic that won the day as Gel pumped a towering 33.81 with his own Icharus model, followed by Galeazzi's 31.38 with an MTA of his own design. It was a flapped Bailey thrown by Betsy Miale Gix that took third at 26.7 seconds. Many excellent throws left the 100 meter circle during the round.

By now the winds had settled in from the north at a steady 3 mph but Gel's 106 juggles was not enough to catch "Wildman Weary's" 232, using a pair of Chet Pterodactyls. When asked later how he felt about going for the master's own record of 502, Mark replied, "I don't think my legs would have held up that long." Interestingly, number 233 was a flat out drop that was in the hands, so one wonders, how long could he have gone?

But with darkness coming, the group had to hustle to get in Aussie round and as it turns out, it may have been GOOD LUCK that forced Mark's drop. The winds now out of the NE at 4, the stage was set for extraordinary scores.

Stevie K, with what would normally be an outstanding 70 points, ended up in 5th. Michael Girvin finished 4th with 79, throwing a Gel Sunshine that truly went 60 meters. Chi-town threw a 40 meter Sunshine (1/2 meter off of 50...OK, so Bob' weak) but managed 2 bulls, 2-8's and a 7 for 83 points...and third place! The round of the day was the 4th when Mark Weary and Will Gix took the field. Both threw phenolic Sunshine's going 50 meters.

Will's first throw netted an 8 for 18 points, followed by Mark's only 40 meter throw of

the round, a sadly under thrown 5 point accuracy catch for 13 total. Will repeated the 18 on the second throw while Mark made the mental adjustments and popped a 50 meter bull. It was Will's turn to flub on the third throw, landing a 5 accuracy catch, while Mark stayed hot, hitting a 19.

By now the potential for records was fading away. To beat Betsy's 1991 world record 89, her husband could give up only one more point, while Mark had 2 to burn and still hit 90. Later accounts showed that neither was aware of this fact, which was perhaps just as well, as both threw perfect 20's on the fourth throw. When Will caught his final throw in the bull, the circle judge, Girvin shouted out, "91! A new world record!" But by the time the spotters and spectators realized the feat, Mark had already let fly and calmly reigned in his own clutch bullseye to shatter Will's still shimmering new record with a 92!

In a stunning display that Reverend Jim summed up from Saint Louis as, "Well, they got the window", the most highly revered event and oldest world record had fallen twice, on two consecutive throws.

As the light quickly faded away, there was the sudden realization that 3 world records had fallen in one day...a new world record for number of records to fall on the same day. Then, as Kim Galeazzi pointed out, that made four world records in one day...a new world record...that was five. Bob interrupted this train of thought to observe that it was the most Mexicans on the field to ever witness the setting of so many world records, so there were six records all in one day. By the end of the next day and the team events, the team called, "I wish we had Stevie K." made up of Stephanie, Bob, Gregg, and Glen Boris, had dominated the competition, setting a new world record in Team Hackey in the process, running the total world records for the weekend to seven...a new record for number of records in a weekend, pushing the official total to eight. the moral? Be there next year!

# USBA INFORMATION PAGE

## Many Happy Returns

Circulation: 400 Worldwide.

Published by the:

**U. S. Boomerang Association**  
**P.O. Box 182**  
**Delaware, OH 43015**

### Mechanical Measurements:

Image area: 9.5" deep by 7.5" wide; 3 columns to a page; width of a single column: 2.25"

### Advertising Rates:

Full Page	\$200
2 Columns	\$150
1/2 Page	\$115
1 Column	\$80
Per Column inch	\$10

10% discount for 4 consecutive issues. All advertisements must be pre-paid in USD by check or M. O. to USBA. Camera-ready copy preferred. The editor reserves the right to refuse any advertisement or cancel a contract without reason. The deadline for all advertisements is March 1, June 1, September 1 and December 1 for the Spring, Summer, Fall and Winter issues respectively. All advertisements should be mailed to:

**Jay Emerson**  
**374 A Roe**  
**Plymouth, MI 48170**

Questions regarding *newsletter delivery status* should be directed to the editor: **Jay Emerson** by calling (313)-416-0966 or by writing to:

**Jay Emerson**  
**374 A Roe**

All newsletter submittals, with the exception of competition; science & technology and Bits & Pieces column materials should be directed to the editor: **Jay Emerson** by calling (313)-416-0966 or by writing to:

**Jay Emerson**  
**374 A Roe**

## USBA INFORMATION

The USBA provides information listings to members at a nominal charge. A listing of boomerang manufacturers; a listing of wood sources; and a listing of boomerang clubs can be obtained by sending a SASE. Allow one ounce postage per listing. A sampling of vendor catalogs or a USBA rule book costs \$2 and a self addressed envelope (no stamps). Send all inquiries to:

**USBA**  
**P.O. Box 182**  
**Delaware, OH 43015**

Chet Snouffer will respond quickly to special inquiries that are mailed to: Chet Snouffer; 51 Troy Rd.; Delaware, Oh 43015. In the event of an emergency, you can contact Chet at (614)-363-8332 (9 -12 AM EST).

## USBA BOARD OF DIRECTORS

### President

Betsylew Miale-Gix: (206)-485-1672

### Vice-President

Chet Snouffer: (614)-363-8332

### Treasurer

John Flynn: (802)-296-2158

### Secretary

Gregg Snouffer: (614)-363-4414

### Directors

Kelly Croman Andretti: (206)-866-6519  
Michael Girvin: (510)-658-2469  
Dean A. Kelly: (503)-581-8050  
Norm Kern: (313)-645-9308  
Mark Weary: (602)-759-3973

All materials related to competition notices & results should be sent to the Competition Editor: **Chet Snouffer**:

**Chet Snouffer**  
**51 Troy Rd.**  
**Delaware, OH 43015**

All newsletter submittals related to Science & Technology and the "Bits & Pieces" column should be sent to the Science and Correspondence Editor: **Ted Bailey** at the address below:

**Ted E. Bailey**  
**P. O. Box 6076**  
**Ann Arbor, MI 48106-6076**

## USBA MEMBERSHIP INFORMATION

All membership dues should be paid by check or money order in USD\$. Make checks payable to: USBA. Domestic and Canadian annual membership dues are \$10 per year. A domestic lifetime membership is \$150. Annual overseas dues are \$20. A lifetime overseas membership is \$250. Check your newsletter label for expiration issue. Mail all checks or money orders to the address below:

**U. S. Boomerang Association**  
**P.O. Box 182**  
**Delaware, OH 43015**

*Membership status* questions should be directed to **Gregg Snouffer** by calling (614)-363-4414 or by writing to the above USBA address.

## New Member Application

Instructions: USBA member should copy this page and fill in his/her name as sponsor. Carry extra copies of this sheet in your boomerang bag and hand them out to potential new members.

name

address

address

city/state/zip or country

phone number (optional)

USBA member sponsor's name

New member: Please read USBA Membership Information above. Send the completed coupon and (\$10) check or M. O. to:

**USBA**  
**P. O. Box 182**  
**Delaware, OH 43015**



## **PRINTED MATTER**

**UNITED STATES BOOMERANG ASSOCIATION  
P.O. Box 182  
Delaware, Ohio 43015  
U.S.A.**