

Many Happy Returns

Issue No. 83

An International Publication of the United States Boomerang Association

Fall 2001

BOOMERANG EXPO 2001



see story on page 10

photo submitted by Brian R. Braye



What's In This Issue!

Page	Contents
2	Nationals Expo 2002: Make plans now for the big event of 2002 in Seattle, Washington
3	Recent USBA News Help the USBA with a membership drive. Find out about Team Trials.
4	Bits & Pieces All kinds of useful information about boomeranging from all around the planet.
8	USBA Election Ballot It is time to vote for the USBA Board for 2002. Volunteers also are needed.
10	Nationals EXPO 2001 Find out who won at the big event of 2001.
13	Allentown Comp Results Barnaby hosts two tournaments and Stevie Kavanaugh sets a world record in Trick Catch.
13	I Beat Pete Dave Hendricks whips a Comcast sports caster.
14	2001 Western Oregon 15 throwers battle it out in the cold Pacific Northwest.
15	Santa Barbara LD Comp There is an underground group of throwers competing one of the most understood events in the Sport. Find out more.
16	FireFlies Gregg Snouffer relates his nighttime experiences at the Outer Banks.
17	Results of Annual Outer Banks Competition John Flynn beats the pack at the Outer Banks 2001 competition.

NATIONALS EXPOSITION 2002

The USBA and Tournament Director Betsylew Miale-Gix is pleased to announce that The 2002 USBA National Exposition will take place in the Seattle, Washington area from June 6 - 9, 2002.

The kickoff event on June 6, 2002 will take place at Marymoor Park in Redmond, Washington and will feature skill building and boomerang construction, design and decoration workshops. Local and National boomerang throwers and craftsman will be on hand.

The main events will take place on June 7 - 9 at Mountain Meadows Farm in North Bend, Washington. This beautiful site features a manicured grass polo field large enough for distance, located in a picturesque small town at the base of Mount Si.

Further details about accommodations, camping and transportation will be provided.

Tentative Schedule of Events:

June 7, 2002 - USBA Individual Core Event Championships. Open to all throwers. Throwers will be given the option to compete in either the Novice, Open or Sport categories. Events will begin at 9:30 AM.

USBA annual meeting will take place at 8:00 PM. Room location to be announced.

June 8, 2002 - USBA Team Events Session 1. 9 AM - 12 PM. This event will offer everyone an opportunity to participate in team

events regardless of skill level. Teams will be put together blending throwers with different levels of experience to compete in 3 events. Events will include Position, Team Hackey Catch, modified Team Endurance Relay and possibly more as time permits.

USBA Team Events Session 2. 1 PM - 6 PM. This event is geared to those who are intermediate level and above. The USBA boomerang teams will compete as units. Other throwers can either put together 4-6 person teams in advance or form pickup teams on site. A minimum of four WBC team events will be contesting including Endurance Relay, Supercatch, Relay, Australian Round.

Alcohol free Sangria party and special boomerang throw to follow.

USBA Auction and Boomerang Craftsmanship Awards. 8pm. Room location to be announced.

June 9, 2002 - H2H Championship 9 AM - 12 PM. Features the top 8 overall and top 8 in each event from the Sport division of the Core Championship tournament on Friday.

USBA Nationals Distance Tourney. 12:30 PM - 7:30 PM (or dark whichever the throwers decide) For the first time since the mid 1980s, a distance event will be part of the USBA Nationals events - for both those already hooked and folks who have always wanted to try distance.

This will be a terrific event in a beautiful local. Make your travel plans now while the airlines need the passengers!

Recent USBA News

The USBA is updating the listings of boomerang manufacturers and clubs. This is your chance to get free publicity for your club or boom business. This service is free to all USBA members.

Please provide the following information:

- 1 Contact's Name
- 2 Manufacturer or club's name
- 3 Address
- 4 Phone
- 5 email
- 6 web page
- 7 products/services offered
- 8 If a club, when you meet and what kinds of meetings, throws, activities you have... what you do.

This information should be sent to Billy Brazelton via email at: braz0026@tc.umn.edu or by post-al mail to:

Billy Brazelton
2082 Como Ave, Apt. 3
St. Paul, MN 55108-2027

The USBA Board is initiating a membership drive, and we need help to succeed. We are asking all boomerang crafter to donate boomerangs to the USBA. The Board will use them in a raffle for new members. As new members sign up, their names, along with the sponsor's name, are entered into a drawing for the boomerangs.

Several crafters have already promised boomerangs – Fred Malmberg, Michael "Gel" Girvin, John Flynn, Eric Darnell, Dan Neelands, Gary Villard, and more.

We need more help. Each boomerang will be featured in MHR as a part of the raffle. Don't let your boomerang be left out

with these fine makers!

Please send in your boomerangs. So, get into your shops, or look around in your bag for fine boomerangs that will promote boomerang art, sport, and science. We will list the donations with a full-featured spread including photographs in a future issue of MHR. The USBA thanks you for all your help with this drive. Please contact Steven "Cookie" Cook with your donation.

Steven Cook aka Cookie
USBA Membership Director
630 Coral Glen Loop
Apartment 303
Altamonte Springs, FL 32714

phone: (407) 445-3267
email: scook1975@hotmail.com

U.S. Boomerang Team Trials

The USBA will be holding the U.S. Boomerang Team Trials in April, 2002, in Kitty Hawk, North Carolina. The purpose of the Team Trials is to select squad members for the U.S. Boomerang Team, which will travel to Kiel, Germany next July to compete in the 2002 World Boomerang Championship.

Tentative U.S. Trials dates are April 12-14, 2002, Thursday through Sunday. The event will be sponsored by Kitty Hawk Kites, who will provide housing and other assistance. The coaching staff includes head coach Eric Darnell and assistant coaches John Koehler and Barnaby Ruhe.

Eligibility to the U.S. Team Trials is open to any U.S. throwers who are current U.S.B.A. members, and who are committed in time and money to competition in Germany at the 2002 World Boomerang Championship.

If you are eligible and interested in attending the U.S. Team Trials, and to get more information about the Trials, please contact John Koehler:

John Koehler
Koehler Studios, Inc.
210 60th Street
Va. Beach, VA 23451

Phone: 757-437-1185
Fax: 757-437-1285
email: john@koehlerstudios.com

New Editor Needed for MHR

The USBA is in need of identifying one or more individuals with an interest in editing this publication. This is a volunteer position, but it has lots of perks. As editor, you will receive numerous newsletters from clubs around the world. You will receive free boomerangs over time to test throw and discuss in your editorials. Be the first to know what is going on in the boomerang world and get to know almost every thrower on a first name basis.

The successful applicant should have a computer system with software that allows you to do desktop publishing. This includes page layout (Adobe PageMaker or MS Word) and graphics processing (Adobe Photoshop or equivalent) software. It really helps to have email and internet access at home.

The USBA will pay for all of your editing expenses and in the past, the USBA has even paid a stipend for each issue (negotiable). The current editor (who really needs a break) will help you get started and other board members will help with the mailing labels, printing and mailing. If interested, please contact Ted Bailey by email at: tbailey@ic.net or call (734)-971-2970.

Bits & Pieces

News From The: USA

Following the tragic events of 11 September, the editor received numerous messages of condolences and offers of support from boomerang clubs and throwers from every corner of the world. The editor, in behalf of all USBA members, thanks all of our overseas friends for their sympathetic messages and for their friendship.

With all the fighting in the Middle East, Barnaby Ruhe's nephew, Alex Ruhe, is walking around the world to aid animal rights and will be contacting boomerangers in Spain, France, Italy, Slovenia, Bulgaria, Turkey, Iraq, Jordan, Iran and India. Let's hope Alex keeps out of Afghanistan.

There are dozens of boomerang clubs around the USA. Some are well organized. Others are just a group of throwers getting together to have fun. If you live in the Indianapolis region, mini-tournaments are held every Saturday at 3 PM with fun throwing, clinics and the day usually ends with a game or two. Contact Tony Brazelton of the Indianapolis Boomerang Club <http://www.usba.org/chapters/indyboomclub> or call 317-883-2334 or email: brazelami@yahoo.com

Congratulations to Tony and Tara Brazelton on the birth of son Joey in mid-September. Joey is pictured below at 36 hours and center

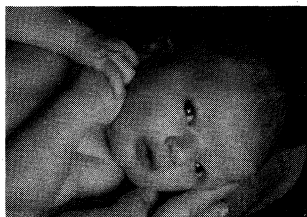

right with his pals Max and Sully.

While test throwing his booms in Ann Arbor, Bill Glover stumbled upon a local Girl Scout Troup quite by accident as they were gearing up for a hike through the nearby woods. Bill only had two RH booms in his bag, one a Aboriginal Steve Tri-blader, the other a Colorado Boomerang's Condor Comp. The Tri-blader worked out fine, but the Condor proved a bit too heavy for them. Bill also had the good fortune to find one natural lefty amongst the girls, and he gave her special attention. She was soon putting the spin to Bill's LMI plastic quad-blader and was getting full returns once she applied a bit of layover; She was a natural and Bill wanted to file adoption papers right then and there! The meeting concluded with Bill accompanying the Girl Scouts on their hike and everyone promising to do it all over again real soon.

Announcing the Rain Festival Indoor Boomerang Tournament on January 6th, 2002, from 2:00 PM to 4:00 PM at the Old Redmond Schoolhouse Community Center in Redmond WA. The tournament will consist of instruction, tuning and warm-up followed by Fast Catch - pole (minimum distance, have to throw from behind a line and around a pole, Trick Catch and other events, time permitting. Due to the small size of the gym and requirements of the city, we are limited to FOAM boomerangs only for this competition - no balsa, no paint sticks, etc. Call Will Herlan at 425-883-3231 or email Will at: blugar@gte.net

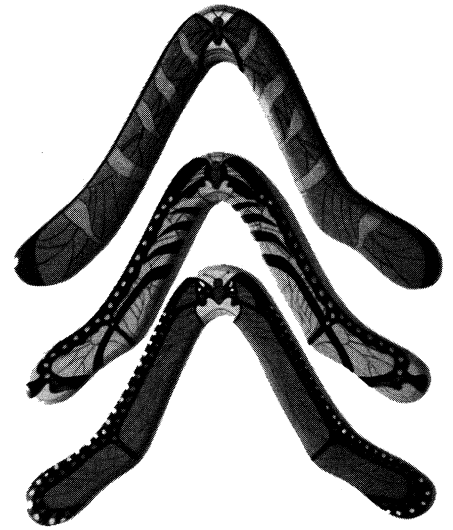

Visit Bill Glover's WWW page and see his butterfly art boomerangs in full color: <http://communities.msn.com/boomerangsbyWJ>

Harald Steck, one of Germany's top throwers is working at MIT in Boston for a year. Harald is looking to meet other boomerang throwers in the Boston area. How about showing him some hospitality and invite him out for a throw. Harald's temporary address is:

**Harald Steck
c/o Patsavos
148 Hancock Street
Cambridge, MA 02139**

Tel. (Home): +1 (617) 547 9669
Tel. (Office): +1 (617) 253 5339

eMail (1.): harald@ai.mit.edu
eMail (2.): steck@mit.edu
eMail (3.): harald@youngguns.de
eMail (4.): haraldsteck@yahoo.de

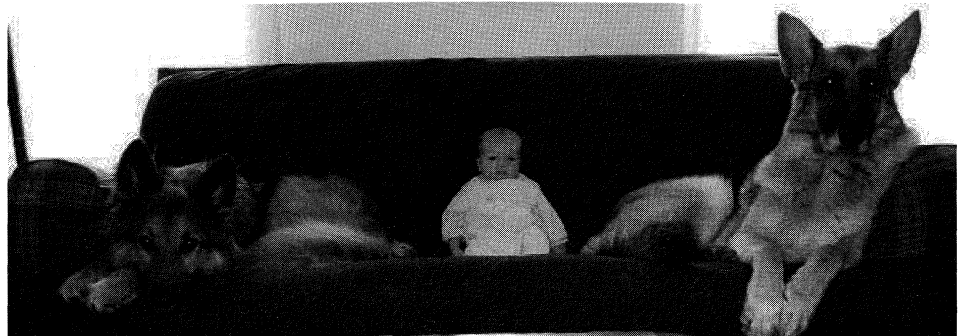

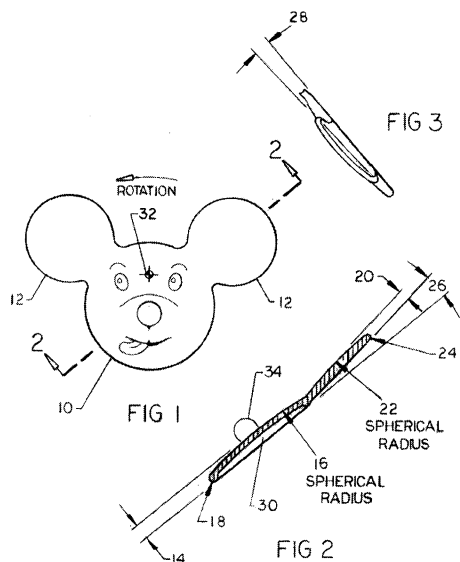

U.S. Patent # 06293879

Congratulations go to Charles D. Moore for being awarded U.S. Patent # 06293879 on 25 September 2001 for a patent depicting a Multi-disk boomerang (looks like a mouse, see drawing above). The abstract for this invention reads: A flying toy of the boomerang type utilizing circular airfoils in the form of disks comprising a main disk with a plurality of control disks affixed to its perimeter at their perimeters, sufficient to provide rigidity and lying in a generally common plane forming a homogeneous one-piece unit. When thrown overhead so as to rotate through the air the combination of disks creates lift throughout 360° of boomerang rotation. The result is a safer, more balanced and stable boomerang that is easy to throw and catch. You can contact the inventor at:

Charles D. Moore
67 Willowood
Aliso Viejo, CA 92656

AUSTRALIA

Roger Perry has made quite a few changes to the combined Spinback/Rangs boomerang factory that he runs. Roger has a new 3 blader designed for adults that

can be tuned for Fast Catch or Trick Catch. It is made of 4 mm plastic so will be just a little thicker than the triFly. For more info, email Roger at: rangs@inet.net.au

ENGLAND

Congratulations go to Bernhard Schmuck for being awarded European patent #0790068 on 17 October 2001 for a competition boomerang, pictured above right. Where have we seen this boomerang before (Georgi D.)? You can write the inventor at:

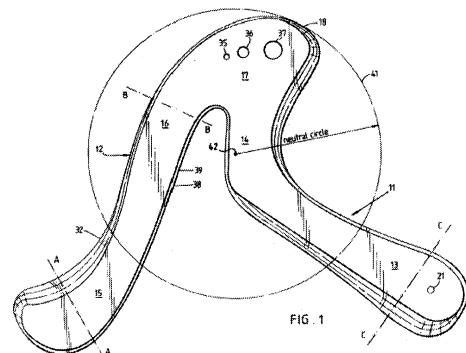

European Patent # 0790068

Bernhard Schmuck
15 Banyan House
Lithos Road
London NW3 6ES
United Kingdom

2001 NSW BOOMERANG CHAMPIONSHIPS

held at Blacktown Showgrounds
on 23rd September, 2001.

Sponsors: Peter and Leonie Adams, Yackandandah.

Results

Competitors	Accuracy	2 min Endur.	MTA 100	Aussie Rd.	Over-all	Veterans O-All
Br. Brian Thomas	20 / 4th	10 / 5th	26.10 / 1st*	32+39=71/4th	14 / 2nd	8 / 1st*
Kevin Moran	22 / 3rd	7 / 9th	16.70 / 3rd	19+33=52/9th	24 / 6th	11 / e3rd
Wayne Patterson	18 / e5th	5 / e10th	12.40 / 8th	22+22=44/10th	34.5 / 9th	
Terry Patterson	26 / 1st*	12 / 4th	13.65 / 6th	43+58=101/1st*	12 / 1st*	
Margaret Patterson	8 / 12th	5 / e10th	10.40 / e9th	21+37=58/7th	39 / 10th	
Gunter Wandtke	15 / 9th	13 / 3rd	18.31 / 2nd	38+36=74/3rd	17 / 3rd	
Doug Boyling	9 / 11th	14 / 2nd	15.60 / 4th	12+25=37/11th	28 / 7th	
Tony Butz	10 / 10th	14 / 1st*	10.40 / e9th	47+35=82/2nd	22.5 / 4th	10 / 2nd
Br.Rod Shoebridge	22 / 2nd	8 / 8th	14.60 / 5th	36+18=54/8th	23 / 5th	11 / e3rd
Paul Croft AJ	18 / e5th	9 / e6th	12.60 / 7th	12+17=29/12th	31.5 / 8th	
Ken Arthur 80	6 / 13th	dnc	dnc	8+4=12/13th	52 / 11th	15 / 5th
Mark Patterson Jn	16 / 8th	4 / 12th	dnc	30+37=67/5th		
Peter Lendrum Jn	18 / e5th	9 / e6th	dnc	30+30=60/6th		

Nearest the Pin: Peter Lendrum 1500mm

Ladies' Champion: Margaret Patterson

Junior Aussie Round Champion: Mark Patterson.

Dave Martin Perpetual Trophy : Terry Patterson.

Thanks to the Blacktown Council for the Showgrounds & Peter & Leonie Adams of Yackandandah.

Welcome back to 80 year old Ken Arthur in his first comp this year. Ken has a bad shoulder injury.

Conditions: Fluctuating breezes and wind. Sunny and hot.

BR. THOMAS VETERAN'S TROPHY: Br. Brian Thomas

This trophy was donated by Tony Butz.

2001 Central Coast Boomerang Championships

held at St. Edward's College, East Gosford, on 14th October 2001

Results

Competitors	Accuracy	Aussie Round	MTA Unlimited
Ken Arthur 80	17 / 3rd	18+12=30 / 4th	22.86 / 1st*
Peter Lewry	12 / e4th	47+20=67 / 1st*	21.09 / 2nd
Kevin Moran 72	20 / 1st*	23+0=23 / 5th	8.86 / 5th
Br. Brian Thomas 63	12 / e4th	30+20=50 / e2nd	14.70 / 4th
Gunter Wandtke	18 / 2nd	24+26=50 / e2nd	15.83 / 3rd

Arthur Janetzki Perpetual Trophy (Aussie Round): Peter Lewry

Nearest the Pin: Br. Brian Thomas 146 cm

Arthur Janetzki Perfect 10 Medal: Br. Brian Thomas

Conditions: Horrible! A downpour the night before flooded the ground. We were true followers of Jesus. Like the good Lord, we had to walk on water! Strong gusty winds blew all day.

Memorable efforts: With a bad shoulder, Ken Arthur's efforts were heroic. Kevin Moran had an MTA flight of over 44 secs, but the catch was just missed.

Thanks to St. Edward's for the use of their ovals and facilities.

Congratulations to all who braved the weather to turn up: the Faithful Five!

FRANCE

Serge d'Ignazio has authored a book in braille to explain how a boomerang works to the blind. The book is in French and is titled "effet boomerang" which means "Boomerang Effect". The book has stereoscopic images illustrating the general anatomy of a boomerang, the profile of a blade with its various components and the trajectory of a boomerang in flight. This book was produced with the technical assistance of the Braille section of the Antony Library. To borrow this book to contact:

**Bibliothèque d'Antony
Section Braille
20 rue Maurice Labrousse
92160 Antony
France**

Tél. 01 40 96 17 17
Fax. 01 42 37 61 20
<http://www.bm.ville-antony.fr>

Congratulations to Antoine Hernandez for setting a new Long Distance Record in France with a throw of 166 metres on 20 October at Mühlacker, Germany. The previous French record was 149 metres, set by Michel Dufayard in 1992.

The top 10 French throwers for the 2001 throwing season are Fred Bureot, Didier Bonin, Yves Caze, Arnauld Tribillon, Eugène Cinal, Jérôme Royo, Julien Kerjan, Yann Giraul, Seb Guiheux & Steph Gignon.

INDIA

Biswajit Mohanty (email:- biswajit_mohanty2001@rediffmail.com) has announced the formation of the Boomerang Association of India. For more information, please contact:

**Biswajit Mohanty
General Secretary**

**Boomerang Association of India
135, Acharya Vihar,
Bhubaneswar
Orissa- 751 013
India**

SWITZERLAND

On Saturday, 18th August 2001 at the 3rd Lausanne tournament, Thomas Stehrenberger set a new world record in Accuracy. He made a perfect round of 50 points. Then he made one more 10 and finally an 8. His final score was 68 points.

As the previous years, the conditions were very good. There was sun with a very low and regular wind. The best scores in the first 4 events were: Accuracy - Thomas Stehrenberger (Switzerland) - 68 pts ; Endurance - Yves Caze (France) - 59 catches ; MTA100 - Fred Declercq (Switzerland) - 49"95 ; Trick-catch/doubling - Oli Thienhaus (Germany) - 170 pts ; Fast-catch - Yves Cazé (France) 18"05 ; Aussie-round - Stephan



Gerry and the PaceMakers show off their boomerangs in a photo on a music scoresheet from the 60s.

Spirgi (Switzerland) - 82 pts (*reported by Frederic Declercq*)

Manuel Schütz is now making composite MTAs. He says it's a lot of work but they are flying great. Manuel lost one after a 5min flight!! They aren't as stiff as the Romblad MTAs but they survive even hard crashes. For more info, email Manuel at: manu.rangs@bluewin.ch

©2001RickLondon/JohannWessels

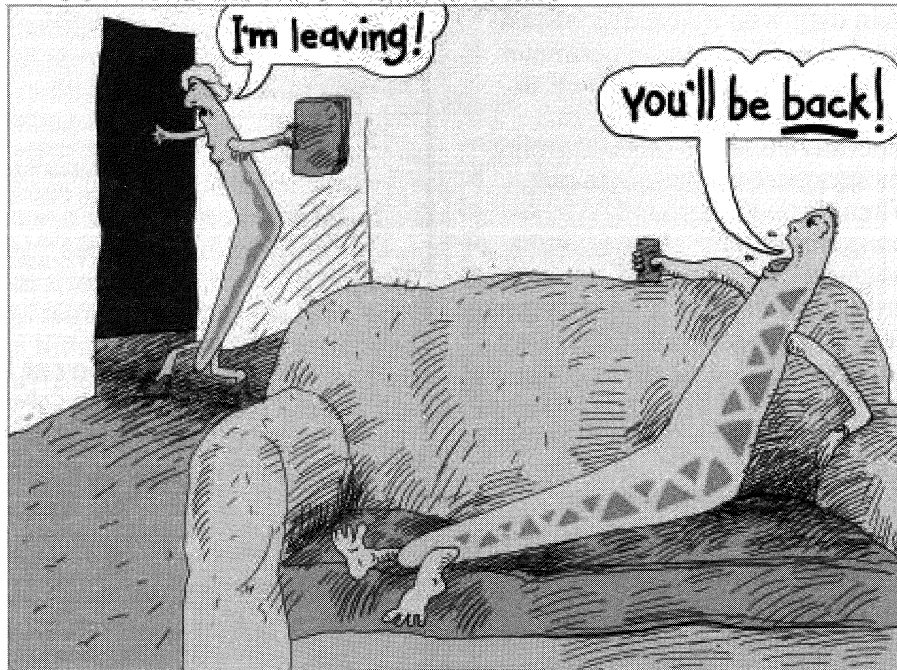

Johann Wessels is an artist who draws cartoons for Rick London's "London's Times Cartoons" web site: <http://www.londonstimes.com> Rick submitted Johann's boomerang cartoon to share with the readers of MHR. Please stop by the London's Times Cartoons web site and sign their guest book! Also, check out: <http://www3.sk.sympatico.ca/wessan>

WWW

Paul Gustafson has a new email address: gustaf@sover.net

A new web master is needed for the Boomerang Web Ring. This is an ingenious system for a visitor to jump from one boom page to another without landing on those extraneous sites that have boomerangs in their title but have nothing to do with boomerangs. If interested, please contact Pat Steigman by email at: pssteigman@tyler.net

Check out the neat article about Stevie Kavanaugh and his boomerang adventures at: [http://](http://seattlep-i.nwsourc.com/lifestyle/44192_boomerang26.shtml)

seattlep-i.nwsourc.com/lifestyle/44192_boomerang26.shtml

Bill Glover found a neat banner gif with a boomerang at: <http://www.ineedhits.com/images/banners6/121055.gif>

Damien Germani of France has posted the Haakon's Web Page at: <http://www.haakon.fr.st/>

Volker Behrens has moved his boomerang web page to: <http://www.sports-boomerangs.com/>

All4hobby is a Dutch outdoor-warehouse in both Dutch and English with a boomerang department: <http://www.all4hobby.com/>

Dwaine Morris has moved all of the Desert Enterprises boome-

rang web sites to: <http://www.azrang.homestead.com/index.html>

Andy Cross found a neat commercial for a device to fight auto-theft called "BoomTrac" at: <http://www.boomtrac.com>

Olivier DUFFEZ has changed the name of his boomerang web site to "Boomerang Passion". The URL is: <http://www.boomerang-passion.com>

Please visit the French L'Ami boom web site with lots of information about boomerang history, plans, throwing sticks and more: <http://www.lamiboom.com/>

Stéphane Marguerite (info@wallabyboomerangs.com) has a new Wallaby Boomerangs web page posted at: <http://www.wallabyboomerangs.com>

You can buy a "More Balls Tahn Most" Boomerang kit for \$25 + shipping at: <http://hotmarketplace.com/top.phtml>

For didjeridoo lovers, check out this new Italian web page: <http://www.didgeridoo.it/>

Check out the Wig-wam Boomerang web site in France: <http://perso.wanadoo.fr/wigwam-boomerang/wigwam-boomerang/>

For a list of terrific boom web pages, check out the Yahoo Boomerang Web Ring: <http://nav.webring.yahoo.com/hub?ring=boomerang&id=31&err=3&list>

Check out a listing of articles about boomerangs written by National Geographic: <http://riptide.nationalgeographic.com/query.html?rq=0&qc=++&qm=0&st=1&nh=10&lk=1&rf=0&qt=Boomerang&x=13&y=10>

The Smithsonian Institution has the Ben Ruhe boomerang archives listed on WWW at: http://www.nasm.edu/nasm/arch/ARCH_REPOS/GUIDE.PT7.html

If you are a competitor, check out the Boomerang USA web site: <http://www.boomerangusa.org/>

MTA's secret reproduction

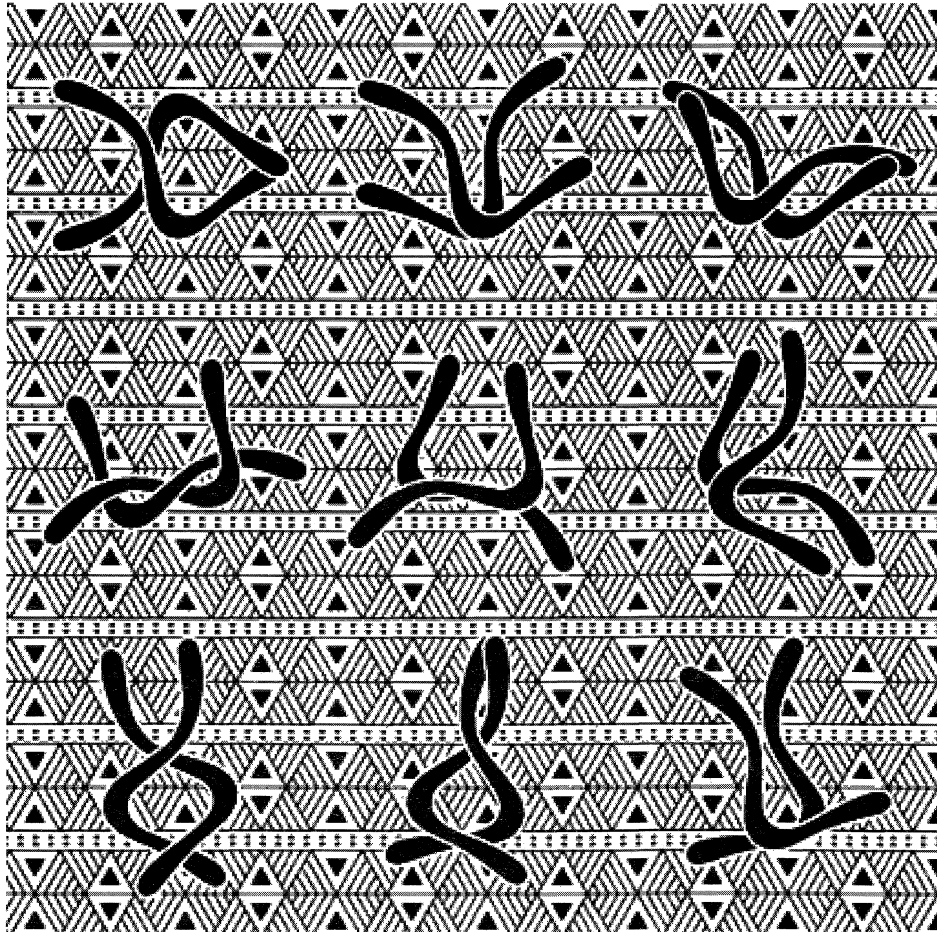

Drawing submitted by Renan GUILLOU of France
email: rguillou@club-internet.fr



USBA ELECTION BALLOT

All Ballots Must Be SIGNED AND POSTMARKED ON OR BEFORE January 5, 2002. SIGNED FAXES WILL ALSO BE ACCEPTED.

Mail to : Betsylew Miale-Gix, USBA Secretary, 3351 236th Street SW, Brier, WA, 98036. FAX 425-485-1672

President

Gregg Snouffer _____

Vice- President

Fred Malmburg _____

Secretary

Betsylew Miale-Gix _____

Treasurer - No candidate. * Pursuant to the USBA Bylaws the new Board will appoint an individual to fill the open position. Those interested in being considered should contact the USBA.*

Board of Directors At Large
Vote one time each for no more than five (5) of the following candidates

Bob Hogan _____

Aron McGuire _____

Mark Legg _____

Adam Ruhf _____

Chet Snouffer _____

Date _____

Member _____

Candidate Statements 2001

President - Gregg Snouffer

My name is Gregg Snouffer and I am running for USBA President. I have been throwing boomerangs since I was 6 years old. I started throwing competitively with the organization that would become the USBA in 1978, when I attended my first Smithsonian Fling in Washington DC on the Polo Fields. Since then I have been involved with the USBA in various ways. Very briefly, I believe we should focus on three very simple avenues that will bring about the growth of our sport, craft and hobby:

1) Re-engage the U.S. boomerang crafters by giving them a product that will entice them to stay involved with the USBA. This involves 2 things. First, an annual national boomerang expo that showcases their work, new ideas in shop layout, boomerang design, technology,... a chance for those with this unique interest to meet up, swap stories and ideas, and to focus attention on their work by providing awards and recognition for their efforts. Secondly, to provide an MHR with a renewed dedication to crafters, with articles and features of interest to them, and which showcase craftsmanship and design stories from the U.S. and around the world. We need to identify an editor who is willing to aggressively pursue photos and articles pertaining to these interests.

2) We need to continue to re-invigorate the sport for those with an interest in competition (as well as those newbies who get exposed to it) by making competitions action packed, fast-paced, challenging, exciting and fun. We should focus our efforts on making competitions friendly to spectators who may come, as well as continue to make it accessible to a tele-

vision market and to aggressively go after sponsorship and media in an effort to bring our product to the national media in some format (ESPN2 or others).

3) To promote our sport, hobby, craft and organization (the USBA) to those out there who haven't been exposed to it yet. This means aggressively and selflessly pursuing sponsorship, television appearances, magazine articles and exciting venues for the sport, art and craft of boomerangs, without jealousy or resentment toward the promotion of any throwers other than ourselves, nor toward the promotion of any aspect of the sport, craft or hobby other than areas in which we are individually interested. Those who run for and hold office in the USBA need to think as promoters for the USBA and for boomerangs over ourselves and the areas in which we hold a particular interest. We need to aggressively pursue promotion in all media for all aspects of our hobby. Let's boot this thing into orbit!

Vice President - Fred Malmburg

Most of you know who I am; "Dr. Fred" has been around a long time, both as a competitor and as a crafter and a theorist. I enjoy these various aspects of boomerangs, and it gives me an unusual over-view of the diversity that is boomerangs. I have been vice president a few years now, and the other Board members and I have some interesting new concepts ready to be introduced in the next year. With your help, I value the opportunity to implement these changes, to keep the US at the forefront of boomerang evolution in all its aspects. If you need to reach the Board on any issue, I am always reachable, and I actively initiate and participate in Board discussions and issues.

Secretary - Betsylew Miale-Gix

This must be the year we finally focus on significant organization building. If elected I will head a Diversified Growth Committee that will involve USBA members both on and off the Board. Our purpose will be to:

1. Re-engage the boomerang crafter hobbyists the USBA has lost touch with over the last few years;
2. Spread knowledge of and information about boomerangs in the general public and encourage participation in our sport at the local level through schools, libraries, scouting groups and others;
3. Encourage development of local boomerang clubs including preparing how to materials and other USBA support. This committee will brainstorm on ideas, develop action plans, budgets and implementation time-lines with project coordinators. I will also continue to coordinate Toss Across America, USBA insurance and perform the other duties of USBA Secretary.

Board Member at Large

Chet Snouffer

In running for the board and not president this year, I think it would be good for the sport to have some fresh perspective up top. It would be nice after the election to perhaps establish some form of succession from Sec to VP to Prexy and set limits of term...maybe 2 years in each position, but not limiting how long a person can serve in different capacities on the board in general. Meanwhile, here are my suggestions for the new year.

1. Moratorium on rules and team selection formats for 2 years. We leave it where it is and spend no

more energy on it. I think the rules need help, but that is the least of our worries. The team selection process I feel very confident of. And again, it's the least of our worries.

2. Promote the heck out of membership through the fliers we did up (FANTASTIC!) and on-line promotions and at demos. We build in some incentives so guys like Gary and I have reason to PROMOTE USBA MEMBERSHIP and not just ourselves when we travel. Some way that there is some benefit to getting others involved.

3. DEVELOP a line of USBA merchandise. A USBA Polo shirt, the USBA T, the USBA travel Bag, patch, window sticker. Sell it on-line by finding a reputable, motivated volunteer to do the store and to stay with it. Their duties would be to stock, sell and to develop further lines of merchandise. This could be a paid position and they could be paid a % of sales. The harder they work, the more they make. It's not a "real job" so don't quit yours, but let's make incentives everywhere for people to produce.

4. Work with companies to market boomerangs and their products. Coordinate with TV, news media, etc...become the official source for boomerang information worldwide. If you are an editor, a director, an attorney in a lawsuit.

5. Grass roots activities. The Toss across is a great Springboard. How about the Vernal Equinox Toss? The Mid-Winter Fest? If we had 3 or 4 annual events that are NOT COMPETITION, but chances to throw and learn and they are coordinated just like TAA?

Adam Ruhf

My experience in this sport should speak for itself, I have been here

as long as anyone. In addition to that, however, I have also a background in top level higher education, experience in grassroots organizing of various social and political contexts, and a unique sense of the world that could contribute to a team of thinkers.

I am ready to implement changes. After years of a semi-stasis, our humble sport is slowly suffocating here in the US, never having even gotten its head above water long enough to take a full breath. Our potential to re-succeed as a country in international competition, and our potential as a marketable, recognizable, and dare I say Lucrative sport lay poised for plucking, and it is my agenda as a board member to begin renovations toward these points.

We are going to need more throwers. Lots. We are going to need the media, big time. I would like to see more effort and recourses put toward these areas, into USBA outreach programs. We need a mass introduction of new throwers. This could be achieved e.g. by tapping into after-school or youth programs; or 'weekly tosses with a pro' a-la Mike Gel; or mass media events with boomerangs woven into a political or social cause; etc. Nike should be clued in. We need to tell them- again and again. Anything that anyone can think of that would promote, recruit, and/or raise funds is exactly what I am talking about. And we will need the help of everyone.

This is my platform. Bigger, Better, Faster, More. I'm looking to, with the help of other like minded enthusiasts, begin the Boomerang Revolution, where by in the evening light of our crusade, we can all lay pool-side, sipping and reminiscing about 9 hour tournaments and paying our own way.

Aron T. McGuire aka Zippy

Somewhere in the United States a young child picks up a boomerang, looks at it with interest, winds up and throws it like a frisbee. As it soars through the sky like a bird taking flight, wind whistling across its sleek airfoils, the child watches it in wonder. The boomerang, gaining altitude, slowing stops, changes direction and abruptly lands on the neighbor's roof. The child, assuming boomerangs don't really work, never throws a boomerang again, ever. Unfortunately this tragic story happens too often across our nation.

I, Aron McGuire (Zippy), am running for USBA Board. I have been an active member of the USBA for over ten years and have been a part of multiple USBA committees. I believe that the future of boomerangs lies in the promotion of the sport and the involvement of its current members. The promotion of the sport will provide a means to bring in new members and expand to new levels. The involvement of its current members can be inspired by creating a fun and exciting environment to get together and do what we love to do, throw boomerangs, talk boomerangs and share boomerangs. As a board member I feel it would be my job to listen and address ideas brought up by the general membership as well as present my own thoughts on the current and future state of boomerangs in the US. Who knows maybe someday we will live in a country where every child knows you don't throw a boomerang like a frisbee.

Bob Hogan

My name is Bob Hogan. I have been tossing boomerangs recreationally and in competition for several years. I was the organizer of the 2001 Spring Break Buggy Blast Boomerang competition where we taught close to 50 people to throw boomerangs and had nearly two dozen of them participate in a "fun" competition. This was the first time that organized boomerang activities had occurred at SBBB.

My main focus in our sport is education and awareness. We have plenty of competitive boomerangers in our organization. The "pros" of the USBA are doing fine. It's the bottom end of the USBA I'm concerned about. With the exception of the Toss Across America that we have once a year, I don't see the USBA actively doing anything on the national level to bring new blood into our sport. I want this to change and will work for its change when elected.

I have been active in the sport of kite flying for a dozen years and am currently the president of the Kites Over New England kite club. We have 150 people in our New England based club. We have workshops, Learn To Fly Programs, Demonstrations and Competitions. I was the co-developer of the American Kitefliers Associations nationally recognized Flight Training program where we introduced sport kiting to the lay public in a non-threatening way. In New England alone, we've produced close to four dozen new sport kite fliers in the last year alone.

In closing, my goal is to work to expand our organization by building the bottom end. If we don't bring new blood into our sport it shall surely die. I love this sport too much and will work my hardest to see that doesn't happen.

USBA National EXPO 2001

by Betsylew Miale-Gix

This year the USBA unveiled a new and expanded Nationals format that had something to offer for almost anyone excited about boomerangs! The three days of throwing featured Individual, Team and Head to Head competitions. There was the design competition, the Junior Individual National Competition, as well as an opportunity to throw rare collectible boomerangs.

The individual competition day was a typical Midwestern day with tricky conditions. Over 50 throwers competed in the individual championship, with 35 competing in the Open division. There was a good mix of established and newer competitors in a well run event which finished in reasonable time. There were some excellent performances as set out below, with no competitor mistake free and running away from the rest of the field.

On Saturday morning the less experienced throwers took center stage, selecting team members for a three event team event which featured Team Position, Fast Catch/Throw, and Relay. The sharing, coaching and fun were contagious as the "pros" and less experienced throwers alike enjoyed the events.

Saturday afternoon saw more serious competitive teams duking it out in a series of three additional events.

Teams included the home town COBRA team, various pickup teams as well as the B-town boys - ringers brought by Adam and Larry Ruhf. Suicide Trick Catch, Australian Round and MTA were contested.

When the dust settled on the team play, it was time to socialize and unwind with collector boomerangs, food and beverages at the Sangria party on the field. Throwers had the opportunity to admire and throw several unusual and rare boomerangs.

Boomerangs by Janetski and Herb Smith were among those available to test drive. This was fun!

Sunday brought the H2H championship featuring the top 8 overall finishers and the top 8 throwers from each event. There were some nota-

ble performances in the somewhat blustery conditions - with John Flynn beating out Adam Ruhf in the Fast Catch final, John Gorski prevailing over Betsylew Miale-Gix in MTA, Steve Cook outdueling Chet Snouffer in Trick Catch, Mark Legg overcame John Flynn in Accuracy.

During the H2H competition, a new event designed to highlight our younger throwers was held called the Junior Nationals. Several aspiring stars of the future competed and Logan Broadbent emerged the champion. Of note, Logan had also qualified for the H2H Australian Round event, so put his youthful energy to good use crossing the field to compete in that event as well.

This was a truly remarkable weekend and the format will in large part be followed again in the Expo 2002 in Seattle in early June 2002.

Individual Championships

Order of Finish 1 - 10

Nobu Iizuka
Chet Snouffer
Adam Ruhf
John Flynn
Betsylew Miale-Gix
Steve Kavanaugh
Casey Larrance
Gregg Snouffer
Steve Cook
Mark Legg

Event Winners

Accuracy
Betsylew Miale-Gix 47

Australian Round
John Gorski 91

Fast Catch
Tony Brazelton 21.36

MTA
Nobu Iizuka 122.50

Endurance
Steve Kavanaugh 54

TC/D
John Gorski 97

<u>RAW</u>	<u>SCORES</u>	<u>ACC</u>	<u>FC</u>	<u>AR</u>	<u>MTA</u>	<u>END</u>	<u>TC</u>
Steve	Kavanaugh	40	28.69	65	82.56	54	78
Chicago	Bob	36	29.61	71	78.46	31	72
Fred	Malmberg	40	54	31	0	21	0
Casey	Lawrence	26	28.13	88	101.96	51	54
John	Gorski	38	45.79	91	87	28	97
Chet	Snouffer	40	21.44	76	92.16	34	76
Tony	Brazelton	18	21.36	55	107.25	45	65
Steve	Cook	36	35.63	62	91.25	40	88
Dennis	Joyce	29	25.06	43	58.11	42	58
Mark	Weary	31	26.58	78	77.85	32	79
Wilson	Lawrence	24	85	20	30	22	44
Adam	Ruhf	36	22.29	57	96.22	50	85
Larry	Ruhf	33	37.33	72	82.35	44	56
Barnaby	Ruhe	34	38.17	40	72.26	44	72
Nic	Yeager	26	27.18	54	71.06	45	72
Gregg	Snouffer	39	28.52	68	85.82	38	84

<u>RAW</u>	<u>SCORES</u>	<u>ACC</u>	<u>FC</u>	<u>AR</u>	<u>MTA</u>	<u>END</u>	<u>TC</u>
Nobu	Iizuka	40	28.21	70	122.5	44	72
Mike	Dickson	26	26.18	61	53.88	38	91
Stuart	Jones	33	31.18	74	99.25	45	41
Gary	Broadbent	34	24.16	61	85.36	33	76
Matt	Golenor	35	47.13	38	85.56	37	53
Eric	Darnell	34	33.59	51	106.64	39	45
Billy	Brazelton	40	36.04	74	59.41	31	56
John	Koehler	30	28.32	65	78.54	39	53
Mark	Legg	44	41.39	61	91.98	42	72
Betsylew	Miale-Gix	47	23.57	70	90.88	45	54
Will	Gix	36	41.5	64	79.02	36	60
Aron	McGuire	25	34.05	74	78.26	34	59
John	Flynn	33	22.49	62	102.66	51	78
Rev	Jim	31	48.22	32	89.77	30	24
Danny	Beauchamp	22	85	70	74.79	33	30
Justin	Brown	43	60.28	40	79.69	37	71
Tom	O'Keefe	32	37.08	57	76.09	24	26
Jason	Smucker	26	32.96	67	87.17	42	64
Carl	Morris	28	31.2	60	65.3	35	39

<u>EVENT</u>	<u>PLACINGS</u>	<u>ACC</u>	<u>FC</u>	<u>AR</u>	<u>MTA</u>	<u>END</u>	<u>TC</u>
Steve	Kavanaugh	4	15	15	18	1	7
Chicago	Bob	11	16	9	23	29	11
Fred	Malmberg	4	32	34	35	35	35
Casey	Lawrence	28	11	2	5	2	24
John	Gorski	10	29	1	14	32	1
Chet	Snouffer	4	2	4	8	24	9
Tony	Brazelton	35	1	26	2	5	17
Steve	Cook	11	22	18	10	15	3
Dennis	Joyce	26	7	29	32	12	21
Mark	Weary	23	9	3	25	28	6
Wilson	Lawrence	33	34	35	34	34	29
Adam	Ruhf	11	3	24	7	4	4
Larry	Ruhf	19	25	8	19	9	22
Barnaby	Ruhe	16	26	30	28	9	11
Nic	Yeager	28	10	27	29	5	11
Gregg	Snouffer	9	14	13	15	18	5
Nobu	Iizuka	4	12	10	1	9	11
Mike	Dickson	28	8	20	33	18	2
Stuart	Jones	19	17	5	6	5	30
Gary	Broadbent	16	6	20	17	26	9
Matt	Golenor	15	30	32	16	20	26
Eric	Darnell	16	20	28	3	16	28
Billy	Brazelton	4	23	5	31	29	22
John	Koehler	25	13	15	22	16	26
Mark	Legg	2	27	20	9	12	11
Betsylew	Miale-Gix	1	5	10	11	5	24
Will	Gix	11	28	17	21	22	19
Aron	McGuire	32	21	5	24	24	20
John	Flynn	19	4	18	4	2	7
Rev	Jim	23	31	33	12	31	34
Danny	Beauchamp	34	34	10	27	26	32
Justin	Brown	3	33	30	20	20	16
Tom	O'Keefe	22	24	24	26	33	33
Jason	Smucker	28	19	14	13	12	18
Carl	Morris	27	18	23	30	23	31

Allentown Fall 2001 Competitions & New Trick Catch World Record

Barnaby Ruhe hosted two tournaments on the same weekend of 29-30 September. It was quite a weekend for Stevie K. In addition to winning the PA boom tourney, he set a new world record in trick catch - 279. After doing a perfect round, none of us could remember the obscure continuation in the USBA rules, so we just voted that he should just repeat the round again. Well, he did another perfect round. So, he went into another round of TC! He made it all the way to the 1HBB and 1HUL in the doubling portion. He made the 1HUL, but could not get to the 1HBB. Adam Ruhf and Cookie tied for second. Peter Ruhf was 4th, Scott Barrett and Barnaby Ruhe tied for fifth.

Tim Maultsby won the Fast catch event at Barnaby's tournament with 24 seconds using an Adam Carroll Fast Catch tri-blader. Barnaby had a 25 second time and then later that night in the second tournament Adam had a 16 second Fast Catch and 73 in Endurance.

Official Press Release from the USBA

American Sets Boomerang World Record

New Trick-Catch Record Replaces German Champion's Mark

Steve Kavanaugh set a new world record in Trick Catch this past weekend at a boomerang tournament in Emmaus, PA. Mr. Kavanaugh, of Seattle, Washington, scored 279 points in the internationally recognized Trick Catch event to edge Fridolin Frost's old record of 262 by 17 points. Mr. Frost is a three time World Champion boomerang thrower from Germany.

In the Trick Catch event, competitors must throw a boomerang out 20 meters before making a series of increasingly difficult catches - first 10 catches are made with one boomerang thrown, the last ten with two boomerangs thrown simultaneously. Catches range from one handed to under the leg, behind the back, and with the feet.

Steve Kavanaugh is a Seattle native who graduated from Garfield High School and the Evergreen State College and employed by the Essential Baking Company in Wallingford. He learned to throw boomerangs while attending the Evergreen State College and has been throwing competitively for fourteen years.

I Beat Pete

By Dave Hendricks, BVD'Rangs

Tuesday evening July 10, I met with Pete Christy from the Comcast Sportsnet in Philadelphia, for an "I Beat Pete" challenge in boomerang throwing. Pete entertains challenges in various sports in an effort to promote less known sports. Pete contacted me about the possibility of a boomerang contest and I accepted. After some instruction and warm-ups Pete and I did the boomerang challenge. We started with a round of Accuracy because it was like the event shown on Survivor and familiar to Pete. The weather was not cooperating and the winds started to gust making throwing difficult. In addition, we were throwing almost on signal from the cameraman that he was ready. In one of the most pathetic displays of accuracy I have witnessed, Pete managed only 3 points and I ended up with only 11. This was for five throws! We both only managed to get two

boomerangs within 10 meters. It was strange because during warm-ups, Pete and I were getting sixes and eights on almost every throw. I guess that turning on the camera and counting scores had us both nervous. In addition, I left my best accuracy booms at home and we used one of my Running Mon boomerangs with holes drilled in it for windy weather. It wasn't the best choice for accuracy but both Pete and I were doing well with it earlier.

Our other event was Aussie Round. Both Pete and I had settled down and did much better. Pete had become accustomed to throwing an AboSteve "Kookaburra" from my bag and wanted to use it. I figured that we could use what he like best. Pete was at a definite disadvantage here as he had only caught one boomerang in practice. We were getting about 40 meters so we awarded 4 points for distance (we had no spotters) and awarded 4 for a catch plus accuracy points. Pete did a lot of running and managed to catch his last one. I had managed to gain some control and caught 4 of 5 thrown. Final score for the event was 44 to 26 with me winning again. We had considered a round of Fast Catch but gave up due to the wind and amount of time available. Fellow co-worker, Karen Bray, and my wife, Barb, helped by taking photos, keeping score and measuring distances for both events.

While Karen totaled the scores: I tried a few trick catches for the camera. The winds again were not good and I missed the catches. In an effort to end the event with a big bang, I decided to make one last throw with my 33" boomerang and ended up catching it 10 feet from the camera. The catch was good enough for 8 points in accuracy or 16 in Aussie Round.

To cap off the session, Pete awarded me an "I Beat Pete" T-

shirt and I gave him a BVD'Rangs T-shirt. Everyone involved (Pete, Karen, Barb, the camera man and myself) signed two commemorative boomerangs that I made and Pete and I each got one.

The session aired on July 25 around 10:45PM and again on July 27. Pete did a great job of editing, and a better job of making me look good. He patched together the Aussie Round segment to make him look like he was continually running around. He added music (come back baby?) and sandwiched a shot of me making a perfect catch in the middle of all his misses. After showing me receiving the t-shirt, and announcing, "I beat Pete!" on camera, he then ended the session with my throw and catch of the mega boomerang. The final seconds show me making the catch, yelling, "Yes!" then turning to the camera and saying, "That was pretty cool."

The incredible part was immediately after the spot ended. The sports anchors for the show are supposed to read the cards that tell how to challenge Pete. Both of them were laughing so had that they couldn't speak. Finally one managed to gain composure enough to say "Thank you, Dave,

for making Pete run around like that." Pete has called to tell me that the segment is one of the best-received ones this year and that favorable comments keep coming in. Several co-workers saw my TV debut and asked me to teach them to throw a the company picnic. The whole process was a lot of fun.

2001 Western Oregon Boomerang Roundup

by Dean Kelly

We had 15 throwers and a lot of fun!

The weather was looking pretty iffy early in the morning, and we did get some drops during the day, but the rain held off until we were almost done with Australian Round, our final event. Some of our east coast (Ohio is on the east coast, right?) throwers were complaining about the weather here at the end of July! As I told them, usually it's hot and windy at my tournament... today it's just wet and windy!

Actually, the wind did not play as much of a factor this year as in years past. I remember one of my early tournaments out at the turf farm. Eric Darnell was there throwing an Aussie Round

boomerang for MTA. He had about 3 dollars in coins and 2 rolls of duct tape on that boom to keep it from blowing away! Fortunately we've never run into another day as windy as that.

The breeze that was there did keep the scores in MTA low, with several good times floating out of the circle. But it didn't affect Fast Catch near as much. Just to make 5th place you had to be sub 26 seconds. Stevie K gave us all a lesson on Fast Catch with rounds of 20.98 and 19.76. By all rights he should of had 1st and 2nd place.

Competition was hot in Accuracy with the top 3 scores being 42, 41, and 40 (Nic Y, Sponge, and Richard B). Aussie Round finished in the rain but still brought in a great winning score by Gregg S of 74. Rather than stick around on the increasingly wet field for GLORP and the awards ceremony we all retreated to Pietro's for some pizza and awards.

A good time was had by all and we're all looking forward to WOBR TV next year! Please note, it will be held earlier in the year to avoid conflicting with some rinky dink tournament on the east coast. Stay tuned for future dates.

Western Oregon Boomerang Roundup XIV

July 29, 2001

Salem, Oregon

No	Thrower	TC	PL	ACC	PL	FC	PL	AR	PL	MTA	PL	END	PL	Ov'l	PL
1	Byron S	65	5	26	11	25.28	5	56	10	44.44	13	28	9	53	7
2	Richard B	17	13	40	3	34.4	10	0	15	44.68	12	19	11	64	4
3	Dan N	24	10	31	8	1.00.04	13	30	13	84.26	2	24	10	56	5
4	Sponge	24	10	41	2	1.06.71	15	41	12	40.29	14	5	15	68	2
5	Andy C	9	14	38	4	35.52	11	67	4	72.57	9	16	12	54	6
6	Nic Y	73	3	42	1	26.71	6	66	6	82.05	4	41	3	23	14
7	Daniel B	47	8	28	9	31.94	9	59	9	58.42	10	31	8	53	7
8	Dean K	21	12	27	10	52.56	12	49	11	52.96	11	16	12	68	2
9	Suzanne R-L	4	15	7	15	1.05.70	14	19	14	39.28	16	8	14	88	1
10	Will G	59	6	36	5	24.6	4	67	4	80.94	5	33	5	29	12
11	Gregg S	86	1	33	7	28.52	8	74	1	79.89	6	46	1	24	13
12	Clay D	38	9	23	13	27.69	7	69	3	76.78	8	33	5	45	9
13	Steve K	78	2	34	6	19.76	1	64	7	83.39	3	44	2	21	15
14	Betsylew M-G	66	4	11	14	22.16	2	64	7	94.32	1	35	4	32	11
15	Doug D	59	6	25	12	23.46	3	71	2	79.18	7	32	7	37	10

Santa Barbara LD Comp 2001

by Clay Dawson

On June 21st and 22nd Erik Fields and Budd Jamieson hosted the United States' premier long distance tournament on Storke Field in Santa Barbara, California, sponsored by UCSB Rec-Sports. The event was truly international with throwers from the Switzerland, Canada, and the US. Storke Field is huge, groomed, and has a good sea breeze, it's hard to imagine a better place to throw long distance.

Long distance is more of an event than a competition. It's more about throwing with others and accurately measuring the throws than who throws the farthest. The experienced throwers like Erik Fields, Dan Neelands, Kelly Neelands, and Tibor Horvath usually line judge. This puts them on the line with the throwers. Allowing them to measure the throws, but even more importantly to coach and mentor the beginners. Anyone who showed up on the field without booms was loaned booms from an experienced thrower's kit. A lot of these booms took many hours to build and tune. To me, this represents the giving spirit of the sport. Also, when anyone gets a great throw or personal best, the whole field celebrates, it's a group effort.

Andy Cross, Budd Jamieson, and Tibor Horvath did an awesome job as head spotters. Their job was to find the range of each legal throw. This isn't an easy job, but these guys made it look easy.

Here are the highlights as I remember them. There were other throwers, but I just don't remember how far they threw.

Erik Fields set the new US record at 158. This wasn't a lucky throw,

he had multiple throw in the 150 range. Spotters standing over 150 meters from the line would mutter expletives of awe or sometimes shout them when Erik threw.

Andy Cross first broke the Canadian record by 1 meter, then decided to bury it with a 129 throw! Way to go, Andy! Andy also makes awesome booms, I know because I was throwing one on Sunday.

Don Monroe broke 100 meters. Everyone in the field was whooping and shouting and dancing around - I was on the line with Don and got a hug, as did everyone else on the line. We all initialed Don's boom.

Dan Neelands had many long throws and broke out of the 120 doldrums with a huge 133 meter throw. Again much dancing and whooping.

Kelly Neelands is totally consistent. She had the most returns for the whole tournament. Kelly isn't a power thrower, it's all finesse, and she has it to the max. Kelly has been on the verge of breaking 100 for a couple of years. You should hear the field when she gets up to throw, everyone is holding their breath. We're sure we'll get to see her break 100 - there is going to be one HUGE celebration when she does.

Budd Jamieson had a bunch of long tosses. One was 153 meters, very close to his old US record. Wow.

Craig, a new guy, was throwing a hook and getting in the 80s. The group talked him into throwing a voyager and he upped his personal best to somewhere in the 90s.

Chris Cotter upped his personal best to 111. Chris also got the highest average throw for Sunday and the most returns. He was on.

Dan Harding had an incredible Sunday, he was throwing why out there and got tons of returns. Dan also provided beautiful prize booms painted by his wife.

Tibor Horvath had many huge throws, but had trouble getting returns. His longest throw ended up being 124 meters. Tibor is an awesome thrower and a great head spotter.

Richard deNuccio showed up with a pocket full of booms he had made the previous week. He threw and threw. While the rest of us were sitting down for lunch, Rick stayed on the field throwing and tuning his booms. This guy has stamina!

I broke my old personal best with a 109 throw then got a 123. Both throws caused much dancing, whooping, and hugging.

On Saturday, Karen Dawson had a bunch of throws in the 80s and 90s, then had a fabulous throw of 100. I think she was stunned, the whole field celebrated. She joined the 100 meter club and got the most radical throw of the day for throwing 100 and using a javelin, front leg up in the air throwing style. On Sunday Karen threw 124 in the first round, the boom dropped just 1 meter behind the line. The field knew it was a long throw, but stood there for a few seconds then started jumping around and whooping. I got much harassing about having to throw farther. None of Karen's throws (mine either for that matter) were hers alone. Tibor, Dan, Erik, Kelly, and others were coaching her between throws. This was more of a group effort than an individual effort.

Am I going back next year? Karen says YES!

Fireflies

By Gregg Snouffer

Fireflies. All I could think of was, "How did all those fireflies get out here on the beach?"

I continued across the Kitty Hawk sand, scrambling first up one giant dune, then tumbling down the other side, as I followed our local companion and guide, Kelly, toward the strange flickering, bouncing lights.

This was our first trip to the Kitty Hawk tournament. Zippy, Nic, Mark Legg, Rev Jim and I decided to go on a weekend boomerang adventure while the airfare was low. It was September 7, 2001, and air travel was still fun.

We all flew into and met up at the Norfolk Airport Friday evening, packed ourselves into a rented Pontiac Grand Am for just \$30 for the weekend, and made our way to Kitty Hawk, where we stayed in the boomerang beach house for free. The whole trip cost each of us \$200 total!

It was the night after the tournament... Saturday night. We had finished the tournament in good time... there were only 14 throwers... then gone to the ocean to film the "Jaws" sequence for the upcoming epic boomerang thriller "The Fifth Throw," starring nearly every boomerang thrower in the United States. Later that evening, after the awards dinner, Tim Maultsby suggested we go out for a dune toss. Us Midwest boys had never been on a dune toss, and decided to go along. But first, we had to make a stop by Kelly's house on the way and got to the dunes after everyone else.

You climb up a giant dune that faces the parking lot and Kitty Hawk Kite Store, but as you crest the dune, you leave the light of the buildings behind and face a sea of darkness and sand, as

scores of smaller dunes stretch across the narrow Cape Hatteras to Pamlico Sound. At night, it is surreal, and what we saw made it even more strange... fireflies... blinking, nodding, spiraling, running, flying fireflies. It was one of the weirdest things I had ever seen. Tim had outfitted a dozen or so throwers with cyalume light stick boomerangs. As we approached we began to make out the people who provided the locomotion for the tiny bugs. After throwing a few times, you wanted to climb up a nearby dune again and just watch them fly, with the rumble of the Atlantic ocean in the distance, the sand-muted sounds of voices and laughter and the dim light of a thousand stars overhead.

Cookie was there... the one companion who had been with Zip and I in Southern Australia, where, on that one magical night, we had thrown lighted booms under the Southern Cross while Aurora Australis glowed eerily overhead, and Adam Ruhf played didgeridoo in the sand on the shore of the Tasman Sea. Cookie knew what magic was, and this was our Eastern U.S. version of it.

I was somewhat dismayed and expressed my concern that Cookie and John Kohler hadn't gotten the word out about this incredible Kitty Hawk tradition. If throwers were aware that they did this each year after the tournament, there would surely be some who would make the journey just for this portion of the weekend!

Later that night came the usual: boomerang throwers at a dance club, shaking sand out of their ears and mixing it up with the locals; their one night out together before the long winter sets in. While I could describe the story that ensued as similar to the hundreds of others that have occurred over the years after different boomerang tournaments, and while you might think that the

story grows old and tired, it never does. Hamburg, St. Louis, Seattle, Corvallis, Geneva, Melbourne, Perth, Ft. Wayne, Hampton, Phoenix, Emmaus, Gaithersburg, Gunnison, Columbus, Ann Arbor, Indianapolis, D.C., Christchurch, Evry, and on and on.... It's a timeless story of airfoils and good times, of friends re-united and celebrating Bernoulli's strange discovery, made over 250 years ago.

A funny thing happened on the way home from the tournament. Sunday morning, while Eric, Barnaby, Kohler, Cookie and Flynnie tested their wings hang gliding in the early morning light, the Midwest boys caught up on a little sleep, and then killed a few spare hours before departure on the sands of Virginia Beach. Aside from the usual stroll down the boardwalk, and nosing through a couple of surf shops, we took a few minutes to jump in the water and frolic in the waves. On our way back up to the car, Rev. Jim noticed that he had dropped his wallet, which he had tucked into his shoe that he was now carrying. We quickly retraced our steps the two hundred or so meters that we had come from the ocean, but to no avail.

As we grabbed a sub at Hero's, we wondered if Jim would be able to board his plane for his return flight to St. Louis without a photo I.D. It was September 9, and we had no idea what would transpire just two days later that would change the nature of air travel forever. So, as Jim checked in at the ticket counter and found that he would be allowed to complete the return leg of his trip by signing an affidavit stating that he was indeed Jim Schramm, Mark and I watched from a distance, while Mark made bad jokes under his breath, like pretending to yell across the airport to Jim, "Osama, hurry up! We'll miss our plane!" I told him not to even THINK about joking like that, while at

the same time subconsciously wondering how many Americans would even get it, given our stereotypically horrible awareness of current events. Who could have known what lay in store just 48 hours later, and the notoriety those events would soon bestow upon one exiled Saudi capitalist-turned-terrorist?

A couple of weeks later, when Jim called me to say that the one person in Virginia Beach who WOULD have turn it in to the police apparently DID find and turn in his wallet, credit cards, money

and all, we nervously laughed at the irony of the whole situation. And we wondered what now would happen to the poor soul who, while traveling, might lose a wallet or purse with their picture I.D. before the return leg of their trip. I'm not sure that a signed affidavit will work anymore. Finally, just a word on the situation that has changed life for all of us. If you frequent the yahoo club "Boomerang Talk," you might have caught a message posted there a few weeks ago. I don't remember who posted it, but in it,

he cleverly alluded to boomerang throwers understanding what the President meant when he urged Americans to get back out and fly. As we head into winter in the Northern Hemisphere, and the winds turn cold, I wonder how much flying we'll do. But one thing keeps me looking forward; spring is coming... and another tournament is being planned... and another boomerang party will follow... and another story will be written. The magic is still there. I think we all know how to fly.

**5th ANNUAL OUTER BANKS
BOOMERANG TOURNAMENT
SEPTEMBER 8th & 9th at FIRST
FLIGHT MIDDLE SCHOOL**

by Karen Swedrock of Kitty Hawk Kites

Kill Devil Hills – On Saturday, September 8th Kitty Hawk Kites held the Outer Banks' 5th Annual Boomerang Tournament. With good weather and a group of 13 competitors, the event was a blast! Registration was set to begin at 9:00 am with the competition running from 10:00 until around 5:30 pm. The events of the day included maximum time aloft, fast catch, Aussie round, endurance and accuracy. After a full day of competing, only breaking for lunch, the crew was ready to unwind for a bit.

Saturday night, everyone met back up at Quagmires for dinner and an awards ceremony. Final results placed John Flynn taking the victory over Gregg Snouffer. The prizes were various recreational activities from Kitty Hawk Kites, including hang gliding lessons and kayak eco-tours. After we were finished at Quagmires, it was off to the annual, although not advertised, night throw. With boomerangs lighted with glow sticks we made our way out to one of the most popular sites on the Outer Banks, Jockey's Ridge. If you've never been to the Outer Banks' Boomerang Tournament, this event alone would be a good enough reason to check it out next year! It was quite a sight, and I can't imagine what the neighbors

thought they were seeing out on the Ridge.

On Sunday, a couple of the throwers were able to stick around to help teach some of the spectators how to throw. We had a good crowd and were able to turn a couple people on to the sport, so it was a nice way to finish off the weekend.

Special thanks to Steve Cook, Eric Darnell and John Koehler for their help in putting the event together. We're really excited about upcoming boomerang action coming to the Outer Banks. You should look for something coming up in April and be sure to mark your calendars now for next year's boom tourney, September 7th and 8th, 2002! We hope to see you there!

Name	Relay		Aussie Round		Accuracy		MTA		Trick Catch		Fast Catch		Endurance		Final	
	Score	Points	Score	Points	Score	Points	Score	Points	Score	Points	Score	Points	Score	Points	Score	Points
Greggie Pooh Snouffer	171.03	1	73	1	8	13	54.41	4	59	1	32.41	4	44	1	25	2
Jonny Kmart	173.74	2	50	5	13	10	59.55	3	36	8	35.03	7	39	3.5	38.5	5
Bunny	182.75	3	49	6	24	4	11.56	13	32	9.5	32.59	5	23	10.5	51	7
Will Nolen	171.03	1	27	12	14	8.5	16.23	12	3	13	31.89	3	25	9	58.5	12
Cookie	182.75	3	33	11	17	7	38.63	9	45	3	37.25	10	22	12	55	11
Free Flow	182.75	3	52	4	14	8.5	19.52	11	38	7	43.66	13	27	7	53.5	9
Timbo Maulstby	182.75	3	24	13	23	5	23.94	10	9	12	38.65	12	23	10.5	65.5	13
Mark Legg	171.03	1	47	7	25	3	52.52	6	32	9.5	36.32	9	35	5	40.5	6
Juice	173.74	2	46	8	19	6	46.61	7	58	2	34.7	6	40	2	33	4
Fast Flynnie	173.74	2	69	2	26	2	53.12	5	41	5.5	31.47	2	39	3.5	22	1
Rev Jim	173.74	2	41	9	4	14	70.44	1	13	11	30.84	1	16	13	51	7
Zippy	182.75	3	58	3	28	1	68.22	2	44	4	35.04	8	26	8	29	3
Nick Yeager	171.03	1	38	10	10	12	46.18	8	41	5.5	37.57	11	30	6	53.5	9
Karen "Boom Babe" Swedrock	2000	4	18	14	12	11	0	14	0	14	1005	14	0	14	85	14

USBA Store

The USBA Store Manager is Billy Brazelton. The store offers USBA bumper stickers and logos. "Boomerangs are coming back!" bumper stickers are \$1, official USBA red logos are \$0.50 each (logo orders of \$25 or more are half price). This is a great way to expose the public to boomerangs,

as conversation-starters or advertising..
To order, call 651-644-3086
or email: update@usba.org
or write to:

Billy Brazelton
2082 Como Ave. #3
St. Paul, MN 55108



USBA Calendar of Events

regularly updated on the web at: <http://www.usba.org/calendar.html>

The Annual Christmas/New Years Tournament will be held in two locations this year: The Evergreen field in Olympia, WA and the Billy Martin Field in Oakland, CA. On January 1, 2002, Michael "Gel" Girvin will run the tournament in Olympia and Dave Grover, Pete Gibson and Kia Ludwig will run the tournament in Oakland! Interested throwers (for either tournament) can contact: Mike Gel at gelboom@gel-boomerang.com or Dave Grover at 510-215-1170 or dlgrover@pacbell.net

6 January 2002 ; Rain Festival Indoor Boomerang Tournament ; Will Herlan ; blugar@gte.net
June 6 - 9, 2002 USBA National Exposition ; Seattle, Washington ; Will & Betsylew Gix ; email betwil@att.net
July 28th - August 9th 2002; World Cup: <http://www.boomerang2002.com>; email: gm@boomerang2002.com
September 7 - 8, 2002 ; 6th Annual Outer Banks Boom Comp ; Amy Thompson ; events@ktyhawk.com

Calendars of Boomerang Events from Around the World Can Be Found At The Following URLs:

<http://www.usba.org/Calendar/index.html>

<http://www.boomerangusa.org/calendar.html>

<http://www.multimania.com/franceboomerang/index.html>

<http://www.bumerangclub.de/>

<http://www.realspace.com/BoomCalendar/>

USBA Board Email Contact Info

President Chet Snouffer - usba@usba.org
 Vice-President Fred Malmberg - fmalmb@pol.net
 Treasurer - Keith Mullinar - k_mullinar@hotmail.com
 Secretary - Betsylew Miale-Gix - betwil@att.net
 Billy Brazelton - update@usba.org
 Steve Cook - scook1975@hotmail.com
 Suzanne Lentz - suzanneraganlentz@earthlink.net
 Larry Ruhf - lruhf@crocker.com
 Gregg Snouffer - boomerang@columbus.rr.com

All USBA members with an email address are entitled to received regular and timely boomerang news updates. All you have to do is send your email address to Billy Brazelton at: update@usba.org

MHR subscriptions are provided to libraries for \$10 per year. Make sure your local library knows about this great deal!

Other USBA Email Contact Info

MHR Editor: Ted Bailey - tbailey@ic.net
 Web Page: Aron T. McGuire - amcguire@locke.com

Don't forget to notify Aron and Ted about your boom event so the info can be added to the internet and newsletter calendar of events.

The United States Boomerang Association

USBA INFORMATION

The USBA is a non-profit organization whose goal is to promote the art, craft and sport of boomerangs through events, competitions, and information distributed through the quarterly newsletter, Many Happy Returns. Your input is welcome. You can contact the USBA by writing to:

U.S. Boomerang Association
1868 Panhandle Road
Delaware, OH 43015

Phone or Fax: (740) 363-4414
 E-mail: usba@usba.org
 Internet: <http://www.usba.org>

USBA BOARD OF DIRECTORS

President
 Chet Snouffer (740) 363-8332
Vice-President
 Fred Malmberg (717) 848-4601
Treasurer
 Keith Mullinar (860) 568-6008
Secretary
 Betsylew Miale-Gix (425) 485-1672
Directors
 Billy Brazelton (651) 644-3086
 Steven Cook (407)-445-3267
 Suzanne Lentz: (206) 784-0453
 Larry Ruhf (413) 323-0774
 Gregg Snouffer (740) 363-4414

Comments on newsletter content, and submissions for inclusion, including articles, photos, cartoons and designs should be submitted to the editor at the address below. The editor reserves the right to edit all material. Inclusion is not guaranteed. The deadline for newsletter submissions is April 1, July 1, October 1 and January 1 for the Spring, Summer, Fall and Winter issues respectively.

Ted Bailey
P. O. Box 6076
Ann Arbor, MI 48106

email: editor@usba.org
 phone: (734)-971-2970

USBA MEMBERSHIP INFORMATION

All membership dues should be paid by check or money order in \$USD\$. Make checks payable to: USBA.

Domestic and Canadian annual membership dues are \$15 per year. A domestic lifetime membership is \$225. Annual overseas dues are \$20. A lifetime overseas membership is \$350.

Check your newsletter label for expiration issue. Membership status questions should be directed to **Keith Mullinar**

Many Happy Returns

Circulation: 174 USA + 42 International
 Published by the:

U. S. Boomerang Association
1868 Panhandle Road
Delaware, OH 43015

Mechanical Measurements:
 Image area: 9.5" deep by 7.5" wide; 3 columns to a page;
 width of a single column: 2.25"

Advertising Rates:

Full Page	\$100
2 Columns	\$ 75
1/2 Page	\$ 60
1 Column	\$ 50
Per Column inch	\$ 5

10% discount for 4 consecutive issues. All advertisements must be pre-paid in USD by check or M. O. to USBA. Camera-ready copy preferred. The editor reserves the right to refuse any advertisement or cancel a contract without reason. The deadline for all advertisements is March 1, June 1, September 1 and December 1 for the Spring, Summer, Fall and Winter issues respectively. All advertisements should be mailed to:
Ted Bailey; P. O. Box 6076; Ann Arbor, MI 48106

Membership Application

Copy this page and carry extra copies of this sheet in your boomerang bag to hand out.

Check: New Renewal

name

address

address

city/state/zip or country

phone number (optional)

email (optional)

USBA member sponsor's name

New members & renewals: Send completed coupon (or copy) and \$15 (\$20 overseas) with check or M. O., payable to: USBA to:

USBA Membership
Keith Mullinar
34 Lorraine Court
East Hartford, CT 06118



United State Boomerang Association

Membership Office

Keith Mullinar
34 Lorraine Court
East Hartford, CT 06118

<http://www.usba.org>

**Renew Now
if the number by
your name is 83!**